

AFTER RUNNING DEMO PROGRAMS,
CAN CUT TRACES IN JP1 TO DISCONNECT
LEDS AND SWITCHES

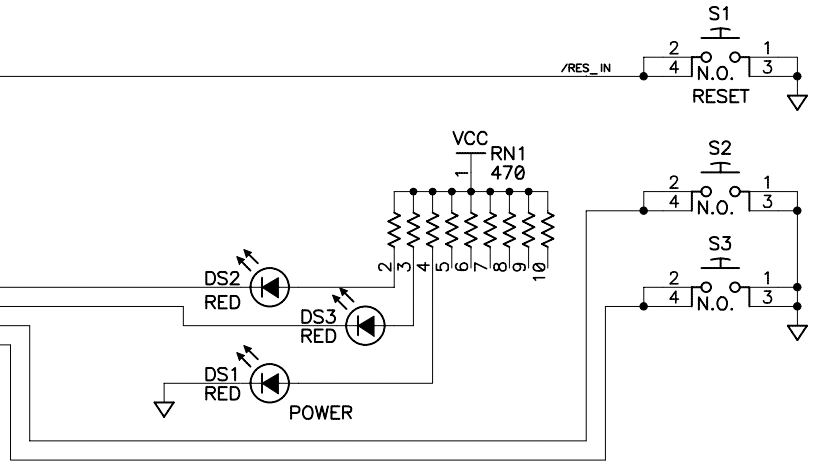

REVISION HISTORY			REVISION APPROVAL			
REV	ECO	DESCRIPTION	PROJECT ENGINEER	APPROVAL DATE	DOCUMENT CONTROL	APPROVAL DATE
A	E11005	INITIAL RELEASE A/W @ REV-A	DM	5/11/00	KAH	5/3/00

APPEND THE FOLLOWING DOCUMENTS WHEN CHANGING THIS DOCUMENT:		DRAWING CONTENT:		TITLE	
		DRAWN BY: (INITIAL RELEASE)		SCHEMATIC DIAGRAM	
		KAH	29FEB00	RCM2000 SERIES	
		REVISED BY:		PROTOTYPING	
		KAH	03MAY00	BOARD	
		APPROVALS: INITIAL RELEASE			
		PROJECT ENGINEER:		SIZE	DWG NO.
		Darren Musgrove	5/11/00	B	090-0099
		ENGINEERING MANAGER:		SCALE	RELEASE DATE
		Doug Wilner	5/4/00	NONE	
		SIGNATURES	DATE		SHEET 1 OF 2

COPYRIGHT 2000, Z-WORLD, INC.

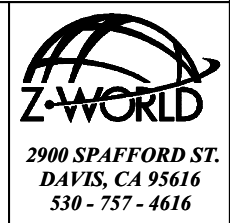

SURFACE MOUNT PROTOTYPING PADS

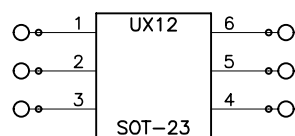
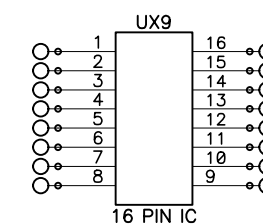
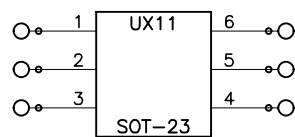
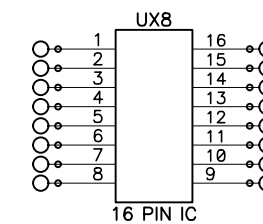
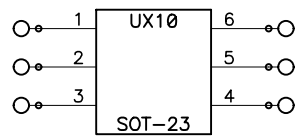
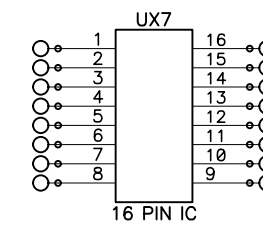
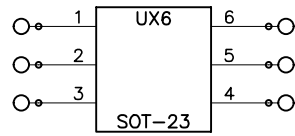
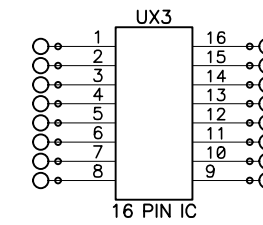
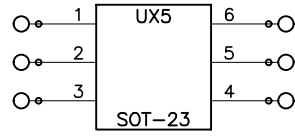
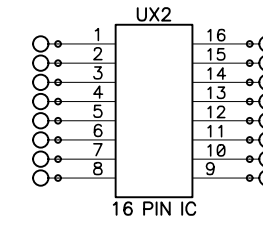
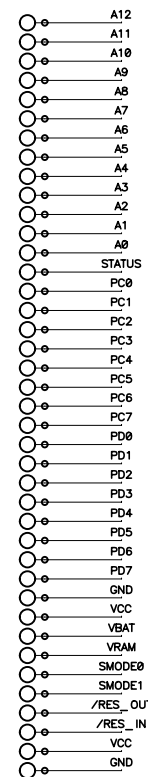
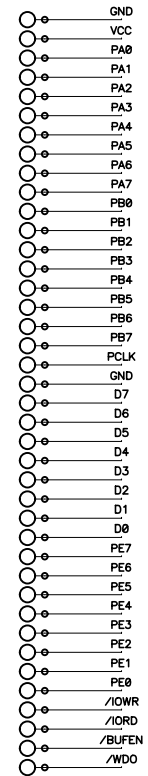
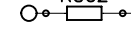
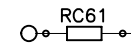
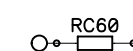
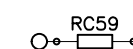
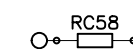
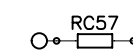
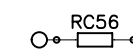
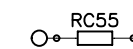
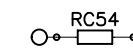
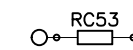
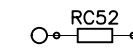
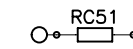
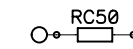
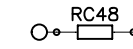
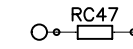
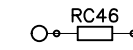
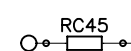
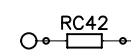
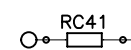
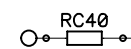
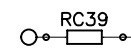
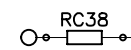
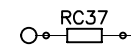
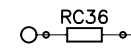
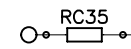
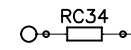
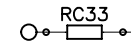
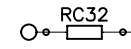
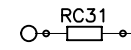
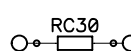
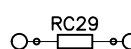
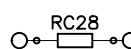
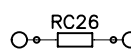
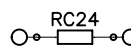
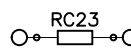
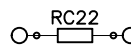
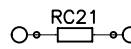
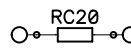
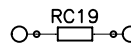
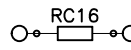
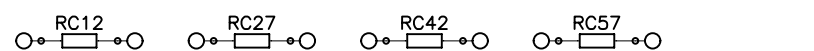
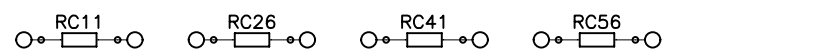
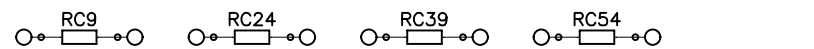
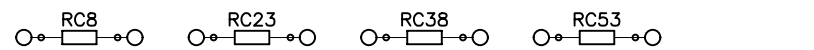
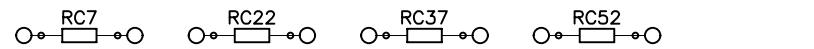
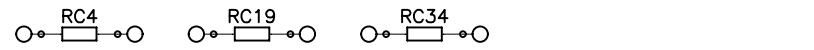
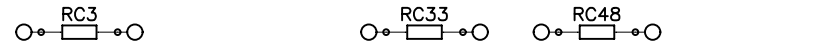
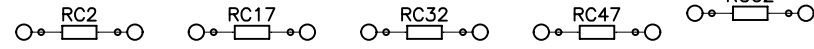
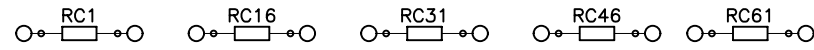
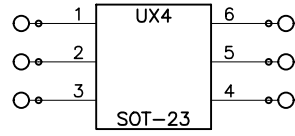
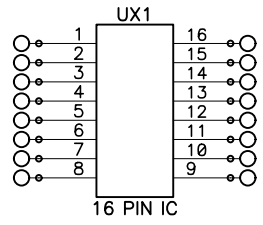

COPYRIGHT 2000, Z-WORLD, INC.

SIZE B	DWG NO. 090-0099
SCALE NONE	REV LTR A
SHEET 2 OF 2	