



TEST REPORT

Test report no.: 1-1554-01-26/09



Testing laboratory

CETECOM ICT Services GmbH
Untertuerkheimer Strasse 6 – 10
66117 Saarbruecken / Germany
Phone: + 49 681 5 98 - 0
Fax: + 49 681 5 98 - 9075
Internet: <http://www.cetecom.com>
e-mail: ict@cetecom.com

Accredited test laboratory:

The test laboratory (area of testing) is accredited according to DIN EN ISO/IEC 17025
DAR registration number: DGA-PL-176/94-D1

Area of Testing: Radio/Satellite Communications

Applicant

Digi International GmbH
Branch Breisach
Kueferstr.8
79206 Breisach / Germany
Phone: -/
Fax: +49 7667 908 200
Contact: Andreas Ortlieb
e-mail: andreas.ortlieb@digicom.com
Phone: +49 7667 908 136

Manufacturer

Digi International GmbH
Branch Breisach
Kueferstr.8
79206 Breisach / Germany

Test standard/s

Arib T66

特定無線設備の技術基準適合証明等に関する規則

Ordinance concerning Technical Regulations Conformity Certification etc. of Specified Radio Equipment Article 2 clause (1) Item (19) (3)

For further applied test standards please refer to section 3 of this test report.

Test item

Kind of test item: WLAN Modul
Model name: ConnectCore Wi-i.Mx51
Frequency [MHz]: ISM band 5150 MHz to 5250 MHz and ISM band 5250 MHz to 5350 MHz (Lowest channel 5180 MHz; highest channel 5320 MHz)
Power supply: 100 V AC by AC/DC power supply
Temperature range: -20 °C to +55 °C



This test report is electronically signed and valid without handwriting signature. For verification of the electronic signatures, the public keys can be requested at the testing laboratory.

Test performed:

Test report authorised:

Marco Bertolino

Andreas Keller

1 Table of contents

1	Table of contents	2
2	General information	3
2.1	Notes	3
2.2	Application details	3
3	Test standard/s	3
4	Test environment.....	3
5	Test item	4
5.1	Cabinet	4
6	Test laboratories sub-contracted	4
7	Summary of measurement results	5
8	RF measurement testing.....	7
8.1	Description of test setup	7
8.1.1	Radiated measurements	7
8.1.2	Conducted measurements	9
8.2	Additional comments	9
9	Transmitter test results.....	10
9.1	Antenna gain	10
9.2	Maximum output power (conducted) / data rate	19
9.3	Antenna power (conducted) & tolerance of antenna power	37
9.4	Frequency tolerance	40
9.5	Modulation method	43
9.6	Spurious emission intensity – conducted & out - band leakage power	44
9.7	Spurious emission intensity - radiated.....	70
9.8	Occupied & spreading bandwidth.....	108
9.9	Adjacent channel emitted power.....	122
9.10	Spreading factor	129
9.11	Staying time.....	129
9.12	Dwell time	130
9.13	Receiver – limit of secondarily emitted radio wave strength - conducted	133
9.14	Receiver – limit of secondarily emitted radio wave strength - radiated.....	136
9.15	Interference prevention function.....	140
9.16	Carrier sensing function	140
9.17	Enclosure requirements.....	140
10	Test equipment and ancillaries used for tests	141
Annex A	Photographs of the test setup	143
Annex B	External photographs of the EUT	148
Annex C	Internal photographs of the EUT	159
Annex D	Document history	163
Annex E	Further information.....	163

2 General information

2.1 Notes

The test results of this test report relate exclusively to the test item specified in this test report. CETECOM ICT Services GmbH does not assume responsibility for any conclusions and generalisations drawn from the test results with regard to other specimens or samples of the type of the equipment represented by the test item. The test report may only be reproduced or published in full. Reproduction or publication of extracts from the report requires the prior written approval of CETECOM ICT Services GmbH.

This test report is electronically signed and valid without handwriting signature. For verification of the electronic signatures, the public keys can be requested at the testing laboratory.

2.2 Application details

Date of receipt of order:	2011-02-17
Date of receipt of test item:	2011-02-17
Start of test:	2010-12-01
End of test:	2011-03-02
Person(s) present during the test:	-/-

3 Test standard/s

Test standard	Version	Test standard description
		特定無線設備の技術基準適合証明等に関する規則 Ordinance concerning Technical Regulations Conformity Certification etc. of Specified Radio Equipment Article 2 clause (1) Item (19) (3)
Arib T66	-/-	Ordinance Regulating Radio Equipment 無線設備規則 Ordinance Regulating Radio Equipment Chapter I General Provision Chapter II Transmitting Equipment Chapter III Receiving Equipment Chapter IV, Section 4.17, Article 49.20.3

4 Test environment

Temperature:	T_{nom}	+24 °C during room temperature tests
	T_{max}	+55 °C during high temperature test
	T_{min}	-20 °C during low temperature test
Relative humidity content:		60 %
Air pressure:		not relevant for this kind of testing
Power supply:	V_{nom}	100 V AC by AC/DC power supply
	V_{max}	110 V
	V_{min}	90 V

5 Test item

Kind of test item	:	WLAN Modul
Type identification	:	Connect Core Wi-i.Mx51
S/N serial number	:	Prototype 55001445-92
HW hardware status	:	No information available!
SW software status	:	No information available!
Frequency band [MHz]	:	5150 MHz to 5250 MHz – ISM band 1 lowest channel 5180 MHz – highest channel 5240 MHz - band 1 5250 MHz to 5350 MHz – ISM band 2 lowest channel 5260 MHz – highest channel 5320 MHz - band 2
Type of modulation	:	OFDM technology with BPSK, QPSK, 16- & 64 QAM modulation
Number of channels	:	8
Antenna	:	External rod antenna → for more information, please take a look at the annex B – external photos of the EUT.
Power supply	:	100 V AC by AC/DC power supply
Temperature range	:	-20 °C to +55 °C

5.1 Cabinet

Evaluation board:

Size	21.0 cm * 18.5 cm * 2.5 cm
Weight	50.83 g without WLAN module
Cabinet	No cabinet! (see photos for details)

Module:

Size	8.2 cm * 5.0 cm * 0.8 cm
Weight	26.35 g
Cabinet	No cabinet! (see photos for details)

6 Test laboratories sub-contracted

None

7 Summary of measurement results

<input checked="" type="checkbox"/>	No deviations from the technical specifications were ascertained
<input type="checkbox"/>	There were deviations from the technical specifications ascertained

TC identifier	Description	verdict	date	Remark
RF-Testing	特定無線設備の技術基準適合証明等に関する規則 Ordinance concerning Technical Regulations Conformity Certification etc. of Specified Radio Equipment Article 2 clause (1) Item (19) (3) Ordinance Regulating Radio Equipment 無線設備規則 Ordinance Regulating Radio Equipment Chapter I General Provision Chapter II Transmitting Equipment Chapter III Receiving Equipment Chapter IV, Section 4.17, Article 49.20.3	Pass	2011-03-12	-/-

Test Specification Clause	Test Case	temperature conditions	power source voltages	Mode	Pass	Fail	NA	NP	Remark
9.1	Antenna gain	Nominal	Nominal	OFDM	<input checked="" type="checkbox"/>	<input type="checkbox"/>	<input type="checkbox"/>	<input type="checkbox"/>	-/-
9.2	Output power / data rate	Nominal	Nominal	OFDM	<input type="checkbox"/>	<input type="checkbox"/>	<input type="checkbox"/>	<input type="checkbox"/>	No passed / fail criteria
9.3	Antenna power (conducted) & tolerance of antenna power	Nominal	Nominal	OFDM	<input checked="" type="checkbox"/>	<input type="checkbox"/>	<input type="checkbox"/>	<input type="checkbox"/>	-/-
		Nominal	Low	OFDM	<input checked="" type="checkbox"/>	<input type="checkbox"/>	<input type="checkbox"/>	<input type="checkbox"/>	
		Nominal	High	OFDM	<input checked="" type="checkbox"/>	<input type="checkbox"/>	<input type="checkbox"/>	<input type="checkbox"/>	
9.4	Frequency tolerance	Nominal	Nominal	OFDM	<input checked="" type="checkbox"/>	<input type="checkbox"/>	<input type="checkbox"/>	<input type="checkbox"/>	-/-
9.5	Modulation method	Nominal	Nominal	OFDM	<input checked="" type="checkbox"/>	<input type="checkbox"/>	<input type="checkbox"/>	<input type="checkbox"/>	-/-
9.6	Spurious emission intensity - conducted	Nominal	Nominal	OFDM	<input checked="" type="checkbox"/>	<input type="checkbox"/>	<input type="checkbox"/>	<input type="checkbox"/>	-/-
9.7	Spurious emission intensity - radiated	Nominal	Nominal	OFDM	<input checked="" type="checkbox"/>	<input type="checkbox"/>	<input type="checkbox"/>	<input type="checkbox"/>	-/-
9.8	Occupied & spreading bandwidth	Nominal	Nominal	OFDM	<input checked="" type="checkbox"/>	<input type="checkbox"/>	<input type="checkbox"/>	<input type="checkbox"/>	-/-
9.9	Adjacent channel emitted power	Nominal	Nominal	OFDM	<input checked="" type="checkbox"/>	<input type="checkbox"/>	<input type="checkbox"/>	<input type="checkbox"/>	-/-

9.10	Spreading factor	Nominal	Nominal	OFDM	<input checked="" type="checkbox"/>	<input type="checkbox"/>	<input type="checkbox"/>	<input type="checkbox"/>	-/-
9.11	Staying time	Nominal	Nominal	-/-	<input type="checkbox"/>	<input type="checkbox"/>	<input checked="" type="checkbox"/>	<input type="checkbox"/>	-/-
9.12	Dwell time	Nominal	Nominal	OFDM	<input checked="" type="checkbox"/>	<input type="checkbox"/>	<input type="checkbox"/>	<input type="checkbox"/>	-/-
9.13	Receiver – limit of secondarily emitted radio wave strength – conducted	Nominal	Nominal	-/-	<input checked="" type="checkbox"/>	<input type="checkbox"/>	<input type="checkbox"/>	<input type="checkbox"/>	-/-
9.14	Receiver – limit of secondarily emitted radio wave strength - radiated	Nominal	Nominal	-/-	<input checked="" type="checkbox"/>	<input type="checkbox"/>	<input type="checkbox"/>	<input type="checkbox"/>	-/-
9.15	Interference prevention function	Nominal	Nominal	-/-	<input checked="" type="checkbox"/>	<input type="checkbox"/>	<input type="checkbox"/>	<input type="checkbox"/>	-/-
9.16	Carrier sensing function	Nominal	Nominal	-/-	<input checked="" type="checkbox"/>	<input type="checkbox"/>	<input type="checkbox"/>	<input type="checkbox"/>	-/-
9.17	Enclosure requirements	Nominal	Nominal	-/-	<input type="checkbox"/>	<input type="checkbox"/>	<input checked="" type="checkbox"/>	<input type="checkbox"/>	-/-

Note:

NA = Not applicable; NP = Not performed

8 RF measurement testing

8.1 Description of test setup

8.1.1 Radiated measurements

The radiated emissions from the EUT are performed in a fully anechoic chamber. The EUT is placed on a non conductive turntable and powered with nominal voltage. The signalling is performed either from outside the chamber with a signalling unit (AP or other) by air link using a signalling antenna or directly by special test software from the customer.

Fully anechoic chamber

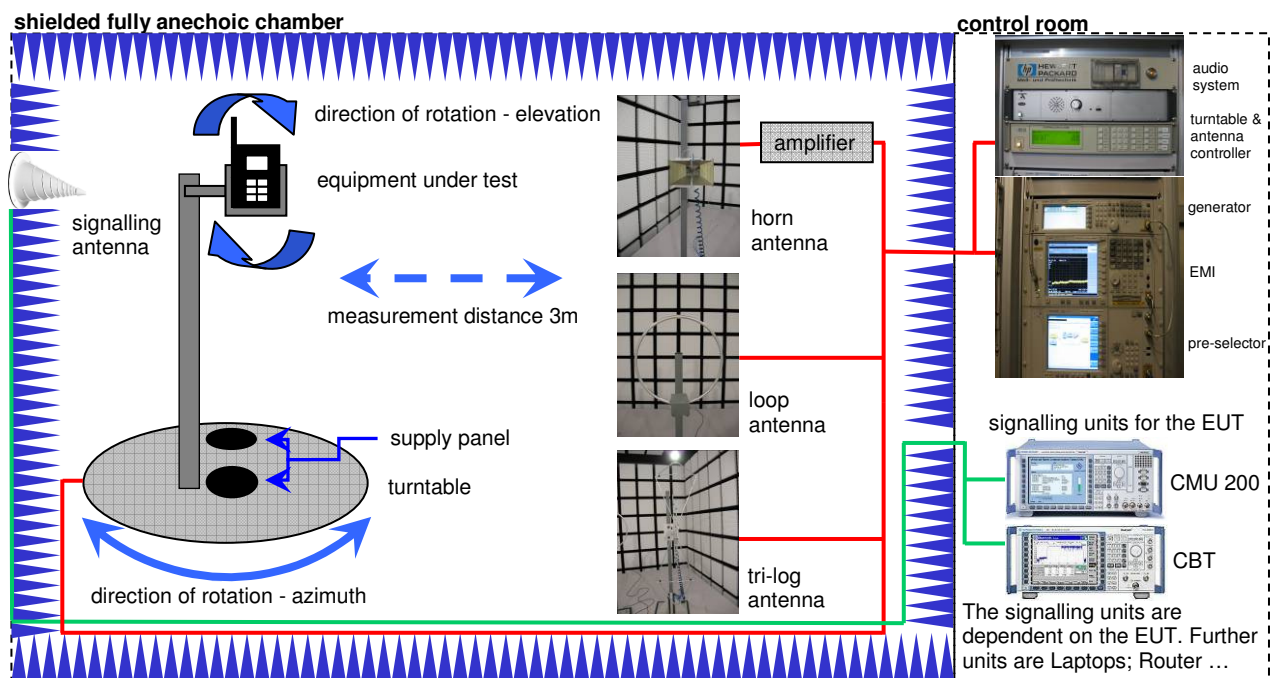

Picture 1: Diagram radiated measurements

9 kHz - 30 MHz:	active loop antenna
30 MHz - 1GHz:	tri-log antenna
>1GHz:	horn antenna

OTA chamber:

The Rectangular Chamber consists of a shielded enclosure constructed of rigid steel panels. The chamber is treated with pyramidal and wedge shaped absorbers. Lighting in the chamber is RF-filtered and consists of four incandescent lamps mounted in recessed waveguide vents in the chamber ceiling. A single leaf swing type shielded door is provided for equipment and personal access into the chamber. The Anechoic Rectangular Chamber is capable of meeting RF attenuation level better than 100 dB throughout the frequency range of 700 MHz to 18 GHz, so that testing performed within the chamber does not interfere with other testing activities at the facility and vice versa. Power is supplied on separate circuits to the chamber and control area. All power filters provide a minimum of 100 dB attenuation over a frequency range of 14 kHz to 18 GHz if tested per MIL STD 220A.

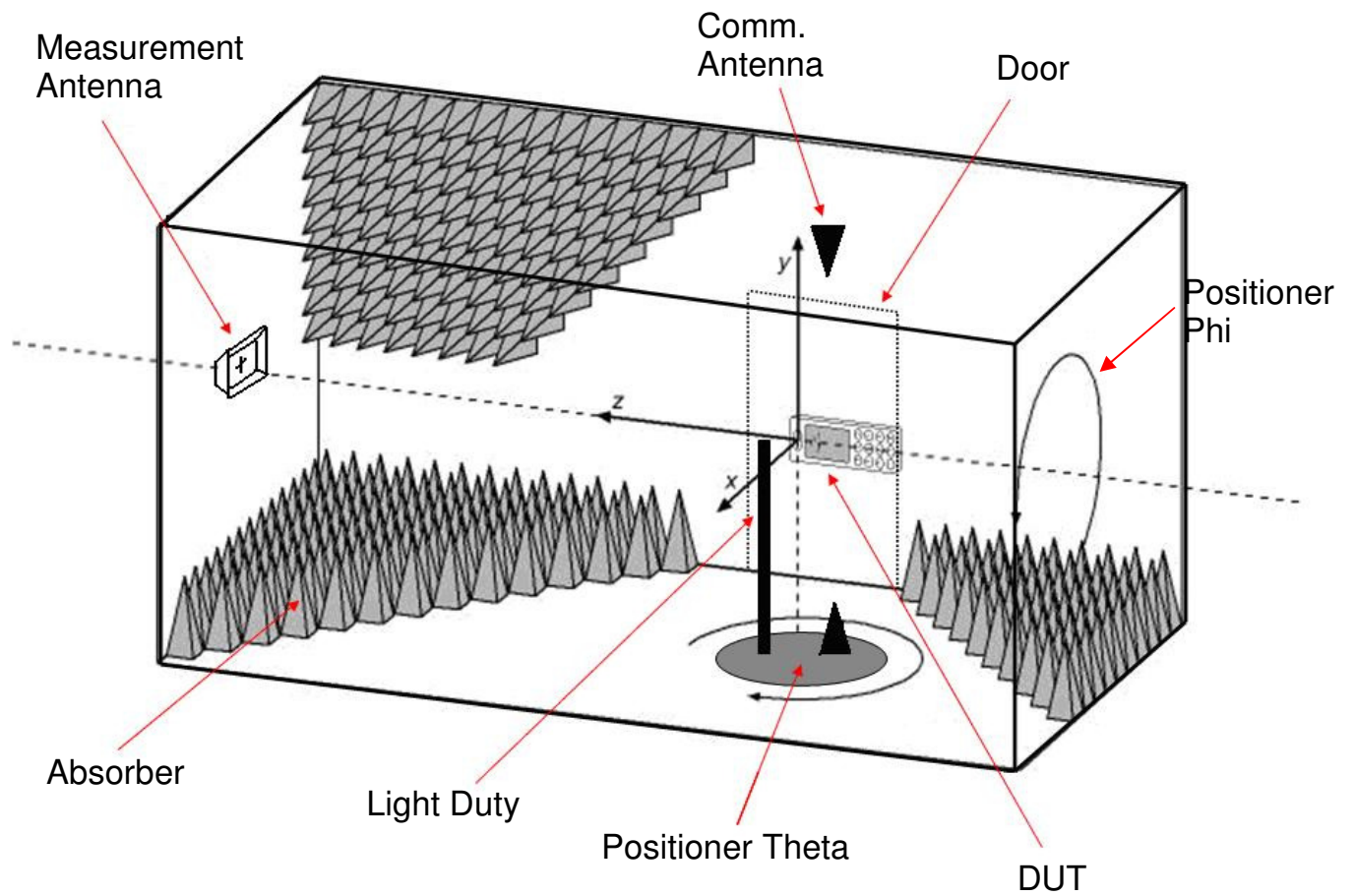
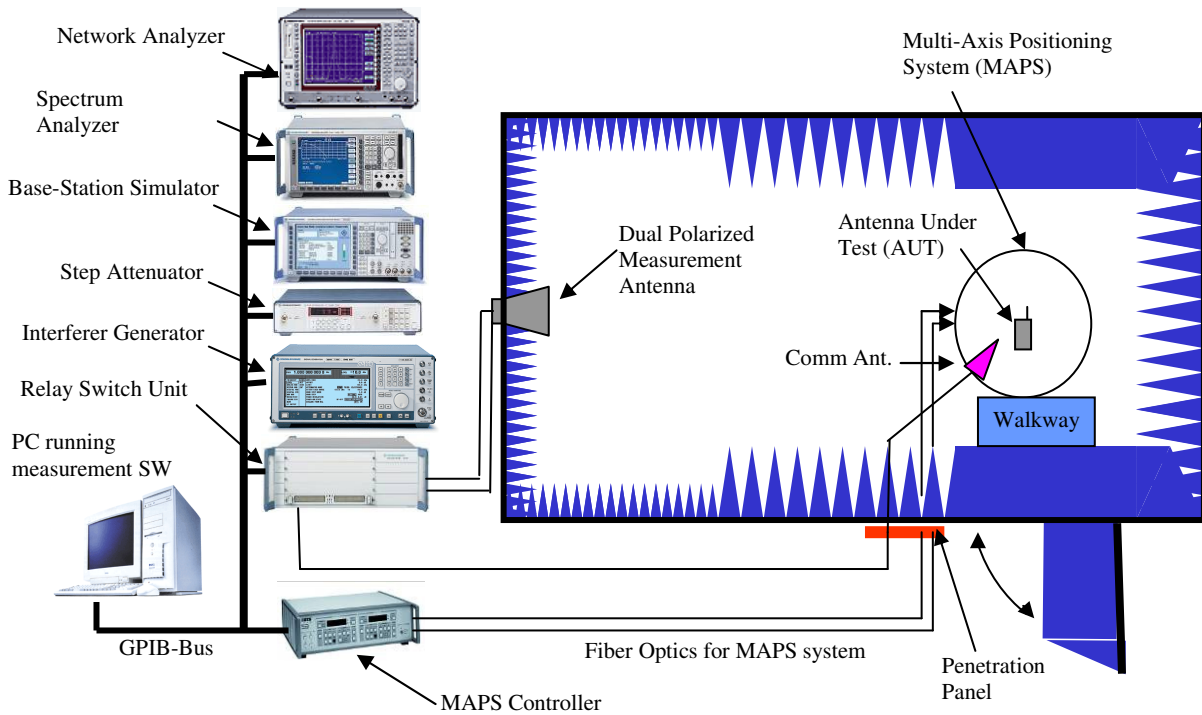

8.1.2 Conducted measurements

The EUT's RF signal is coupled out by the antenna connector which is supplied by the manufacturer. The signal is first 10dB attenuated before it is power divided (~6dB loss per branch). One of the signal paths is connected to the signalling unit (AP or other), the other one is connected to the spectrum analyzer. The specific losses for both signal paths are first checked within a calibration. The measurement readings on the signalling unit/spectrum analyzer are corrected by the specific test set-up loss. The attenuator, power divider, signalling unit and the spectrum analyzer are impedance matched on 50 Ohm. If special software is used, there is no power divider necessary.

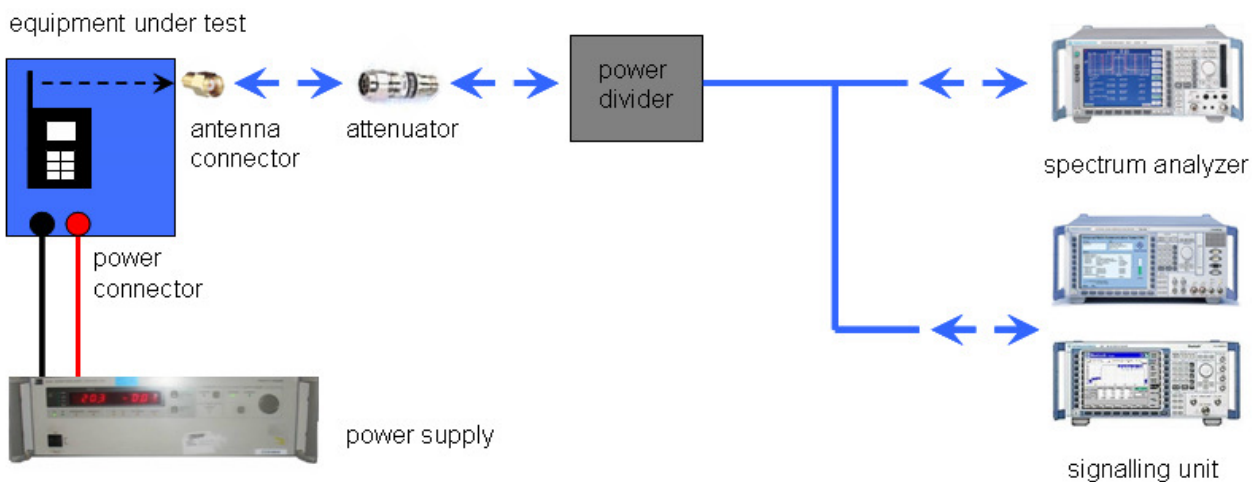

Picture 2: Diagram conducted measurements

The term measuring receiver refers to either a selective voltmeter or a spectrum analyser.

Frequency being measured f	Measuring receiver bandwidth 6 dB	Spectrum analyser bandwidth 3dB
$f < 150 \text{ kHz}$	200 Hz or	300 Hz
$150 \text{ kHz} \leq f < 25 \text{ MHz}$	9 kHz or	10 kHz
$25 \text{ MHz} \leq f < 1000 \text{ MHz}$	120 kHz or	100 kHz
$1000 \text{ MHz} \leq f$		1 MHz
NOTE: Specific requirements in CEPT/ERC/Recommendation 70-03 [2] shall be applied where applicable.		

8.2 Additional comments

Provided channels: 5180 MHz, 5200 MHz, 5220 MHz, 5240 MHz, 5260 MHz, 5280 MHz, 5300 MHz, 5320 MHz

9 Transmitter test results

9.1 Antenna gain

The antenna gain is calculated by the difference of radiated power in EIRP and the conducted power of the module. Caused by the large emission bandwidth of more than 10 MHz the gain is by comparing the measurement results of the radiated and conducted measurement using a RBW of 1 MHz. So these results don't reflect the total radiated power of the EUT.

Measurement parameter	
Detector:	RMS
Sweep time:	20s
Resolution bandwidth:	1 MHz
Video bandwidth:	3 MHz
Span:	Zero span
Trace-Mode:	Max Hold
Additional EUT parameters:	Power index 21 OFDM

Results:

	lowest channel 5180 MHz	mid channel 5220 MHz	highest channel 5240 MHz
Conducted peak power [dBm] OFDM (measured)	-5.14	-4.96	-4.68
Radiated peak power [dBm] OFDM (calculated)EIRP*)	-1.07	-0.85	-0.44
Gain [dBi] calculated	4.07	4.11	4.24

*) max found peak (see Annex Antenna Diagram)

Results:

	lowest channel 5260 MHz	mid channel 5280 MHz	highest channel 5320 MHz
Conducted peak power [dBm] OFDM (measured)	-4.81	-4.78	-4.78
Radiated peak power [dBm] OFDM (calculated)EIRP*)	-0.35	-0.47	-0.53
Gain [dBi] calculated	4.45	4.31	4.25

*) max found peak (see Annex Antenna Diagram)

Limit:

No limitation! Maximum EIRP = 10 mW / MHz

Result: The result of the measurement is passed.

Plots:

Plot 1: Antenna diagram, 5180 MHz (vertical) – all values are in dBm

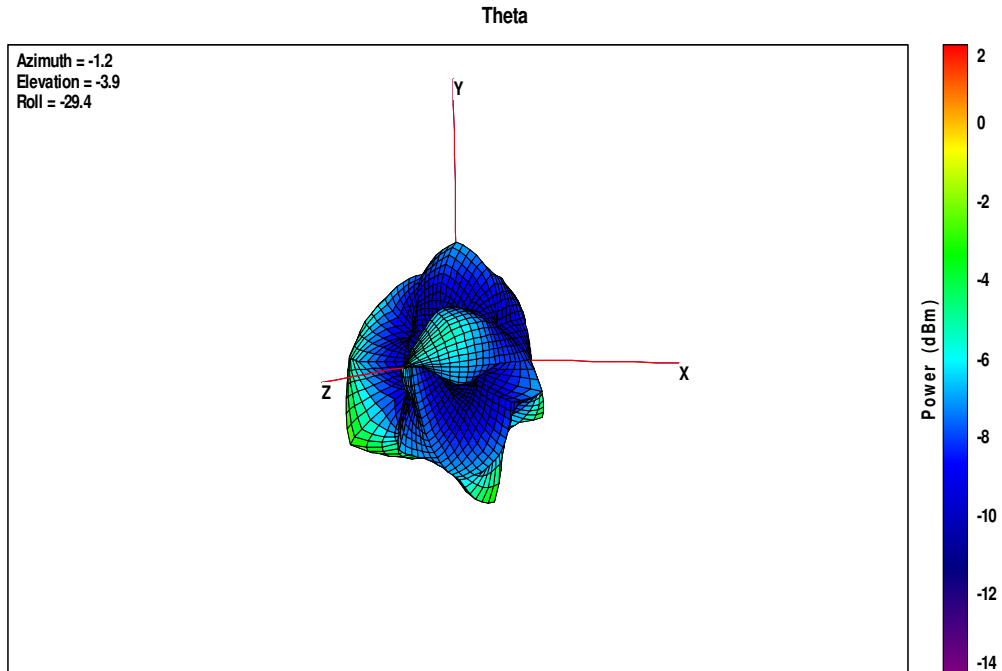

Plot 2: Antenna diagram, 5180 MHz (horizontal) – all values are in dBm

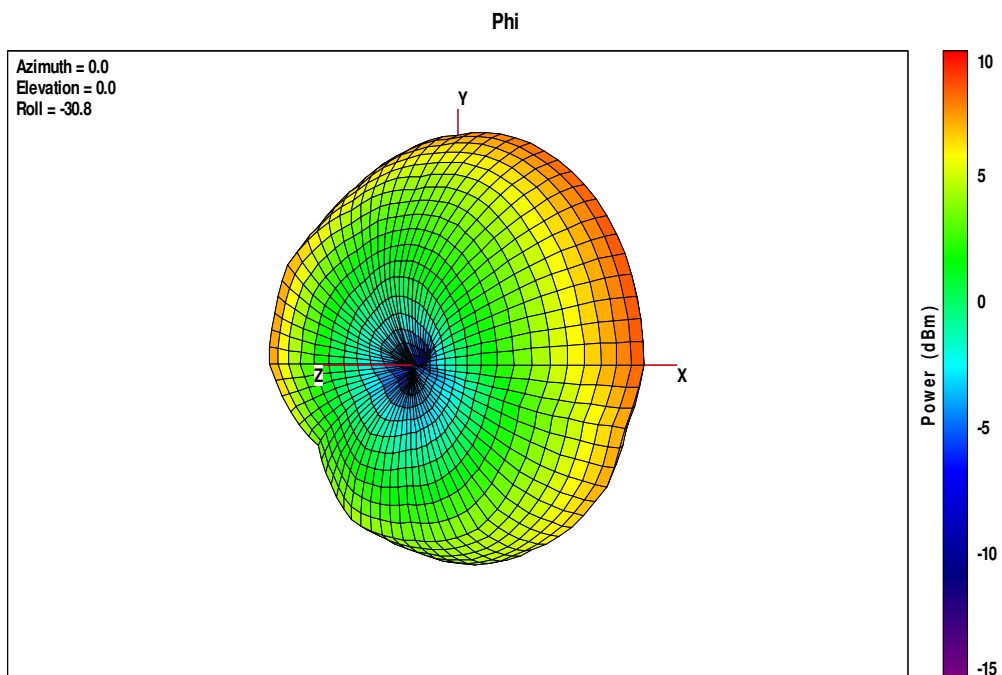

Plot 3: Antenna diagram, 5180 MHz (vertical & horizontal – vectorial summation) – all values are in dBm

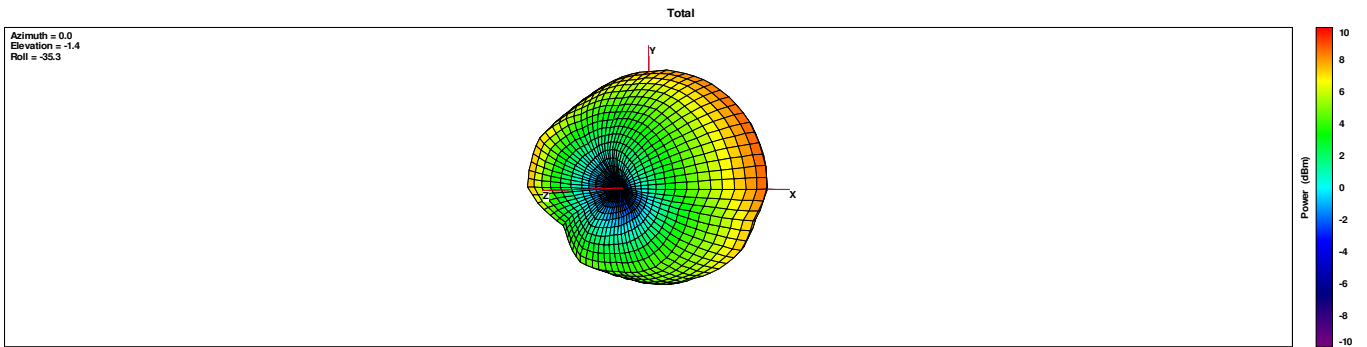

Plot 4: Antenna diagram, 5240 MHz (vertical) – all values are in dBm

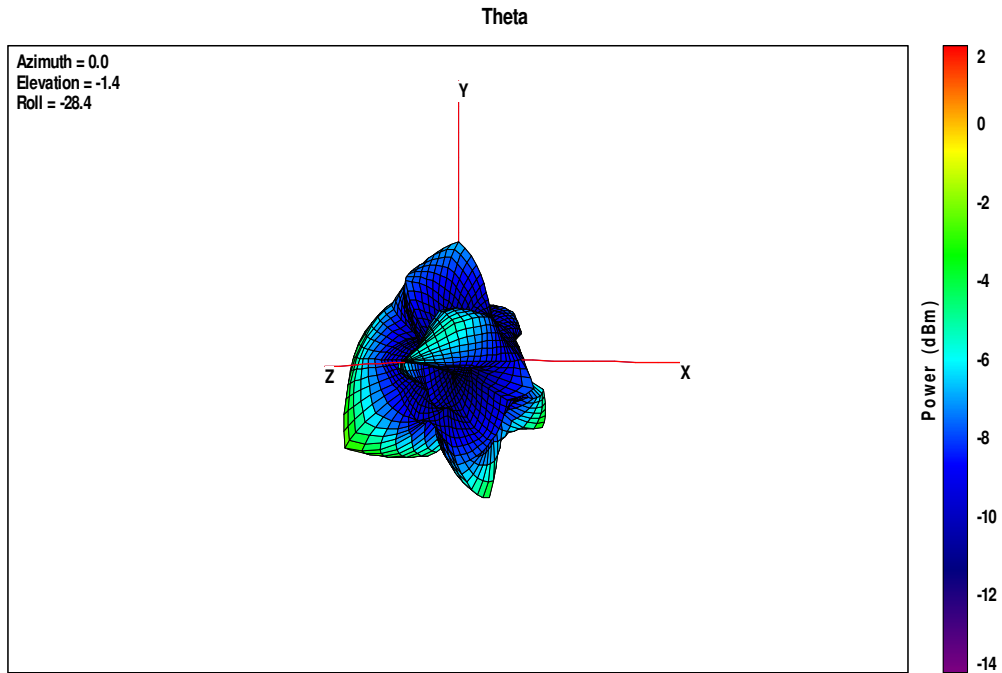

Plot 5: Antenna diagram, 5240 MHz (horizontal) – all values are in dBm

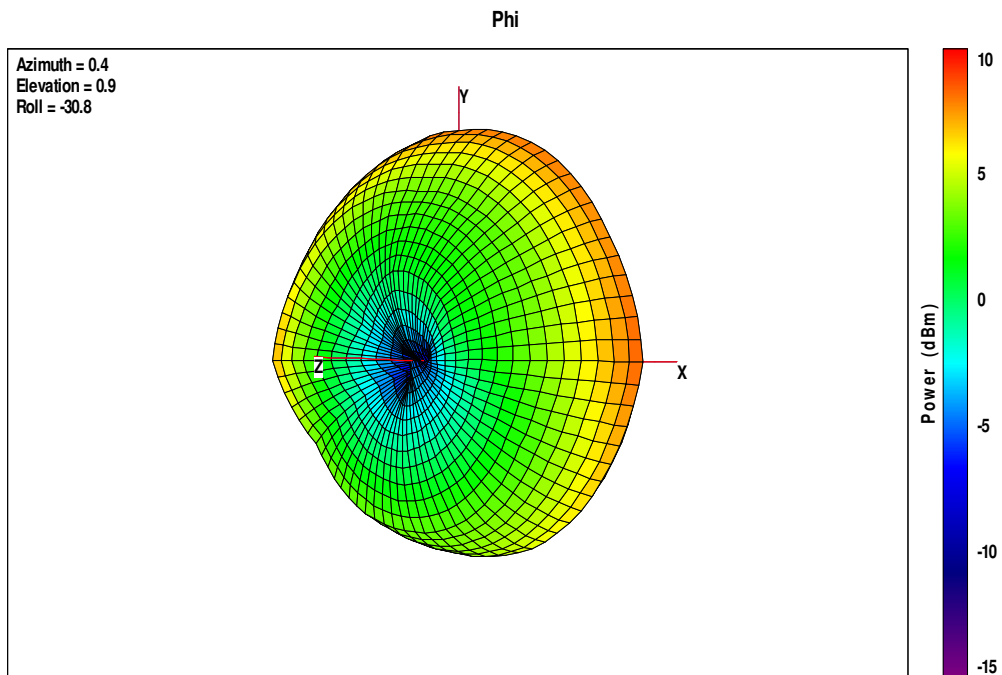

Plot 6: Antenna diagram, 5240 MHz (vertical & horizontal – vectorial summation) – all values are in dBm

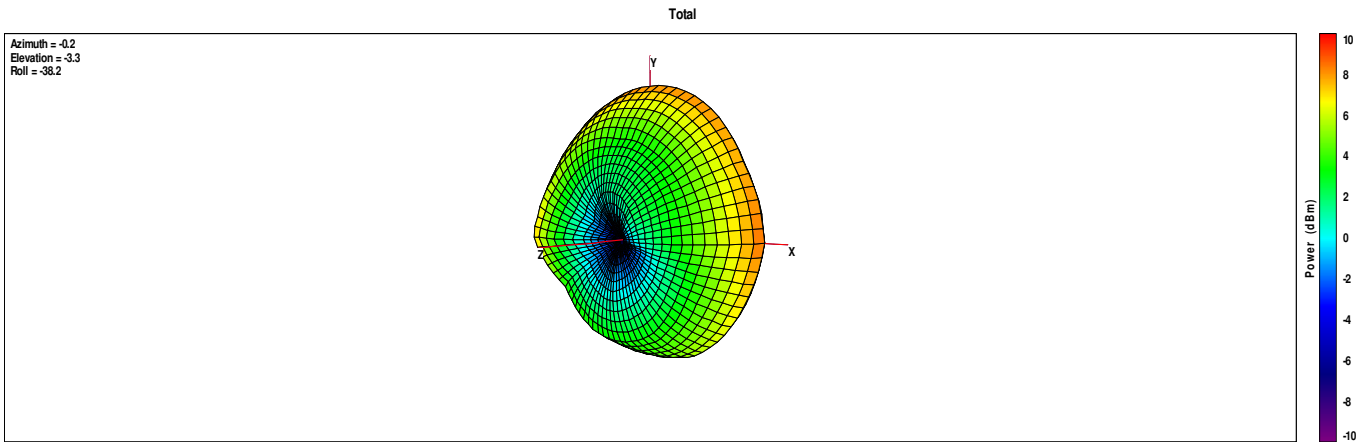

Plot 7: Antenna diagram, 5260 MHz (vertical) – all values are in dBm

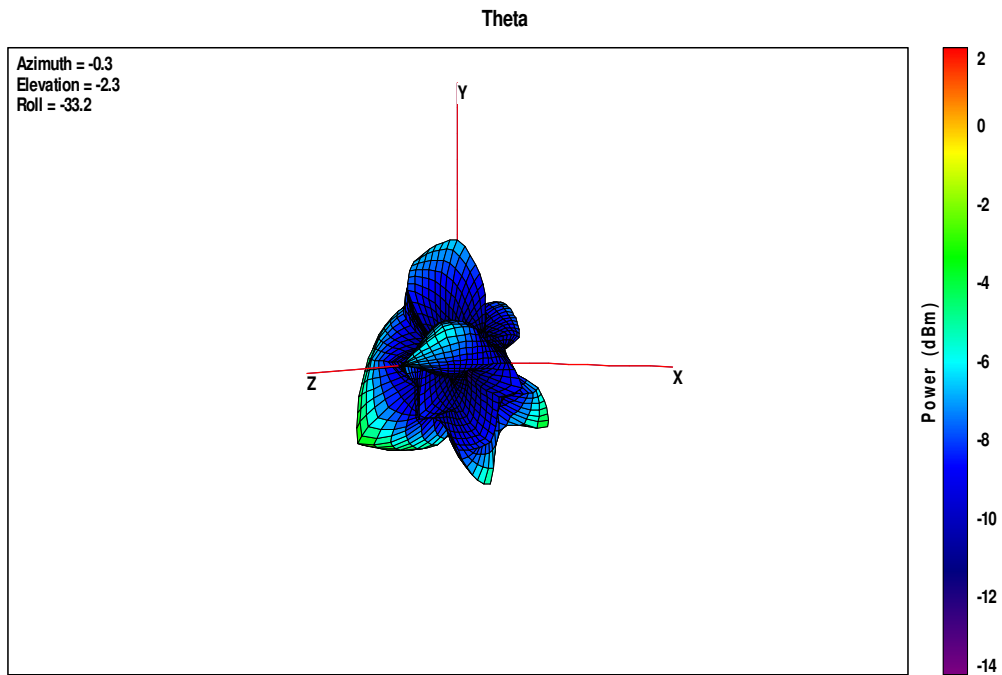

Plot 8: Antenna diagram, 5260 MHz (horizontal) – all values are in dBm

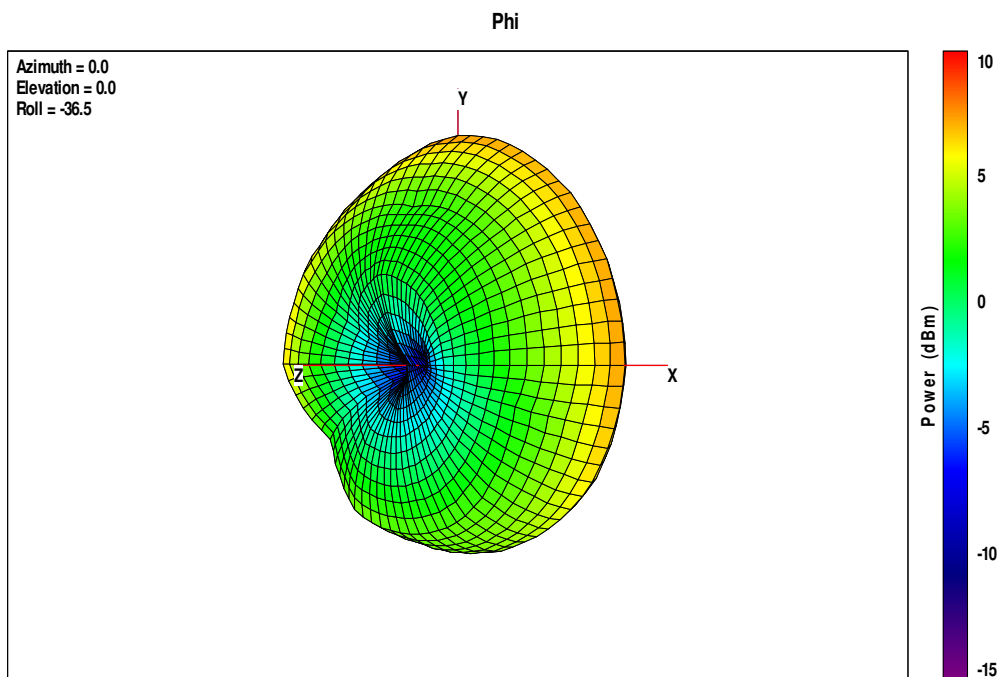

Plot 9: Antenna diagram, 5260 MHz (vertical & horizontal – vectorial summation) – all values are in dBm

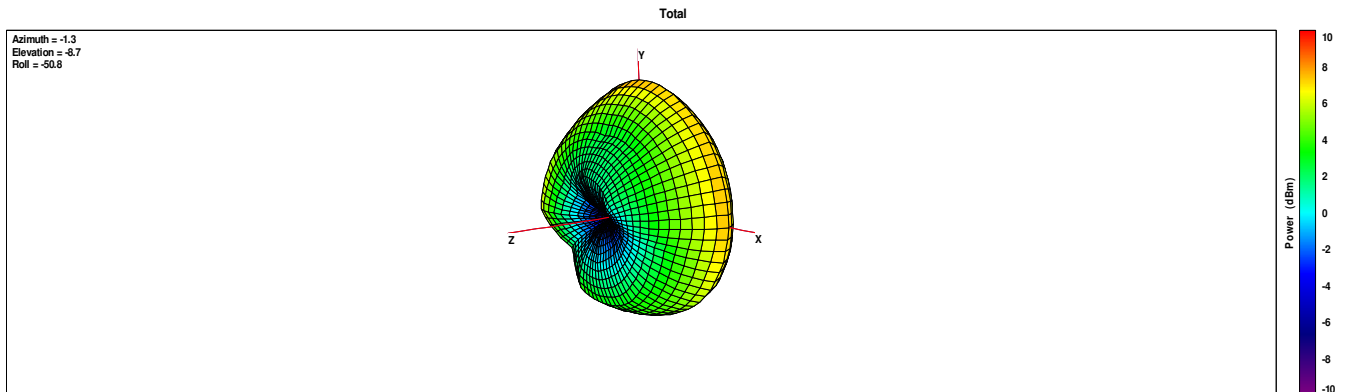

Plot 10: Antenna diagram, 5320 MHz (vertical) – all values are in dBm

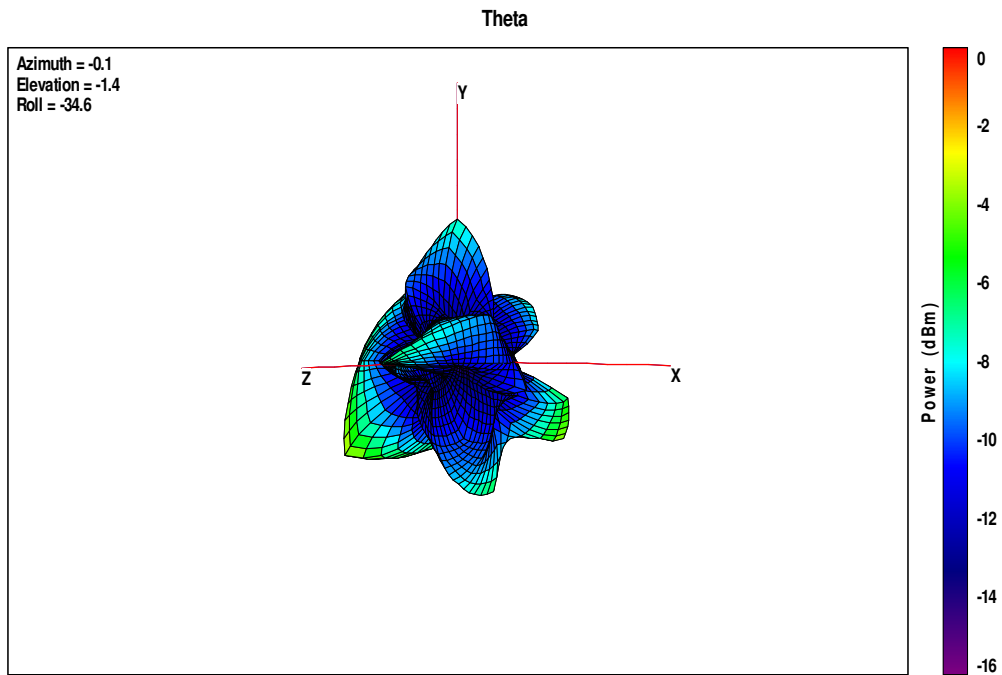

Plot 11: Antenna diagram, 5320 MHz (horizontal) – all values are in dBm

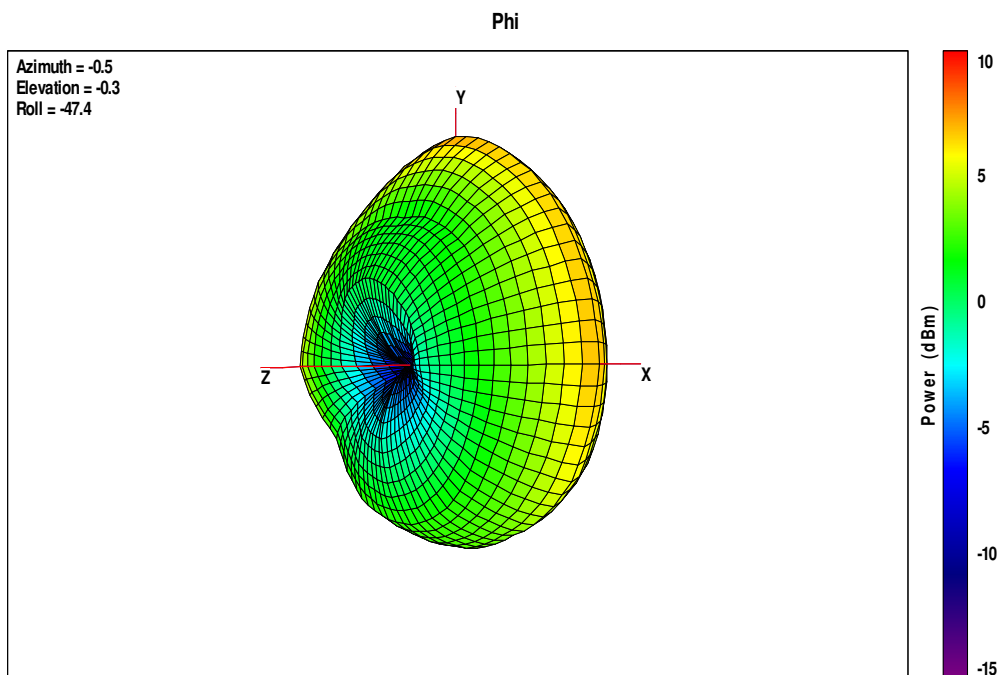

Plot 12: Antenna diagram, 5320 MHz (vertical & horizontal – vectorial summation) – all values are in dBm

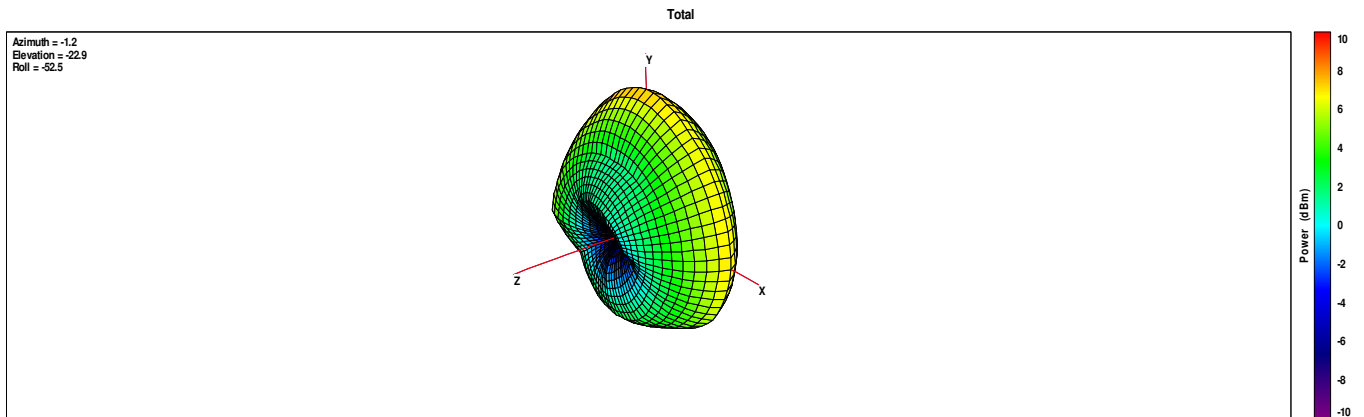

9.2 Maximum output power (conducted) / data rate

Description:

Measurement of the maximum output power conducted. This measurement is performed only at the middle channel in both modes and all data rates to determine the data rate per mode which results in the highest output power. This mode will be selected for all further measurements.

The used measurement settings are for the data rate verification only and not a passed / fail criteria.

Measurement:

Measurement parameter	
Detector:	Sample
Sweep time:	Auto
Video bandwidth:	1 MHz
Resolution bandwidth:	1 MHz
Span:	30 MHz
Trace-Mode:	Max hold

Results: band 1

OFDM Data Rate [MBit/s]	Maximum Output Power Conducted [dBm]							
	6	9	12	18	24	36	48	54
Ch 40 - 5200 MHz	11.77	11.76	11.64	11.60	11.96	12.18	12.30	12.46
Measurement uncertainty	± 0.5 dB							

OFDM Data Rate [MBit/s]	Maximum Output Power Conducted [dBm]							
	mcs0	mcs1	mcs2	mcs3	mcs4	mcs5	mcs6	mcs7
Ch 40 - 5200 MHz	11.94	11.91	11.80	12.34	12.52	12.44	12.60	12.65
Measurement uncertainty	± 0.5 dB							

Result: Selected data rate for all measurements:

OFDM / a – mode: 54 MBit/s
OFDM / n – mode: mcs 7

Results: band 2

OFDM Data Rate [MBit/s]	Maximum Output Power Conducted [dBm]							
	6	9	12	18	24	36	48	54
Ch 56 - 5280 MHz	11.64	11.62	11.50	11.64	12.14	12.24	12.31	12.47
Measurement uncertainty	± 0.5 dB							

OFDM Data Rate [MBit/s]	Maximum Output Power Conducted [dBm]							
	mcs0	mcs1	mcs2	mcs3	mcs4	mcs5	mcs6	mcs7
Ch 56 - 5280 MHz	12.08	11.86	11.83	11.92	12.34	12.43	12.54	12.59
Measurement uncertainty	± 0.5 dB							

Result: Selected data rate for all measurements:

OFDM / a – mode: **54 MBit/s**
 OFDM / n – mode: **mcs 7**

Band 1: 5150 MHz – 5250 MHz

OFDM – mode / a – mode:

Plot 1: OFDM – mode; middle channel – 5200 MHz; power index 21; 6 MBit/s

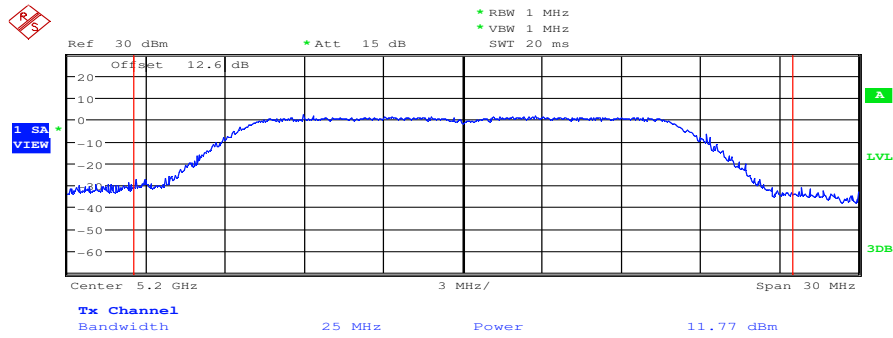

Date: 1.DEC.2010 13:58:26

Plot 2: OFDM – mode; middle channel – 5200 MHz; power index 21; 9 MBit/s

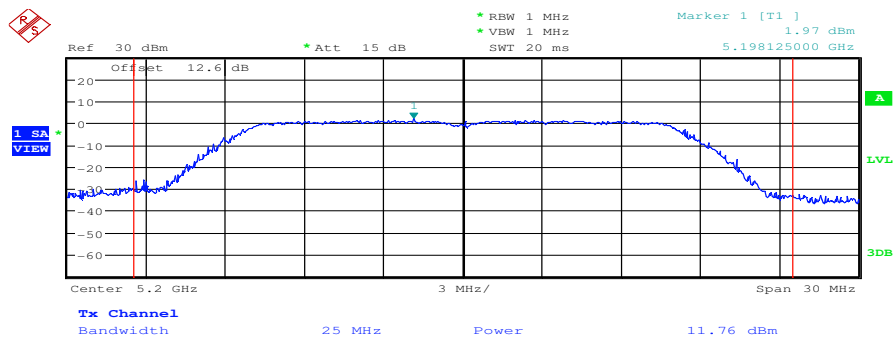

Date: 1.DEC.2010 14:00:15

Plot 3: OFDM – mode; middle channel – 5200 MHz; power index 21; 12 MBit/s

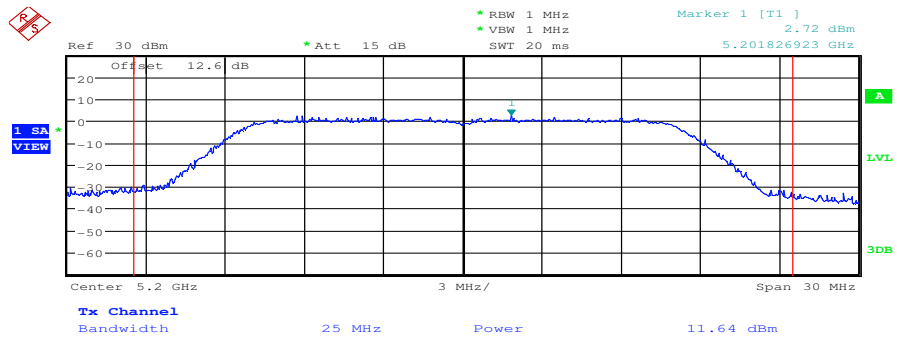

Date: 1.DEC.2010 14:03:16

Plot 4: OFDM – mode; middle channel – 5200 MHz; power index 21; 18 MBit/s

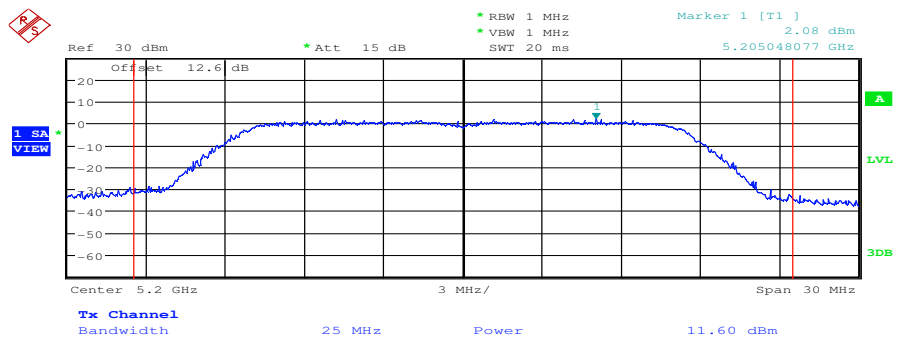

Date: 1.DEC.2010 14:04:56

Plot 5: OFDM – mode; middle channel – 5200 MHz; power index 21; 24 MBit/s

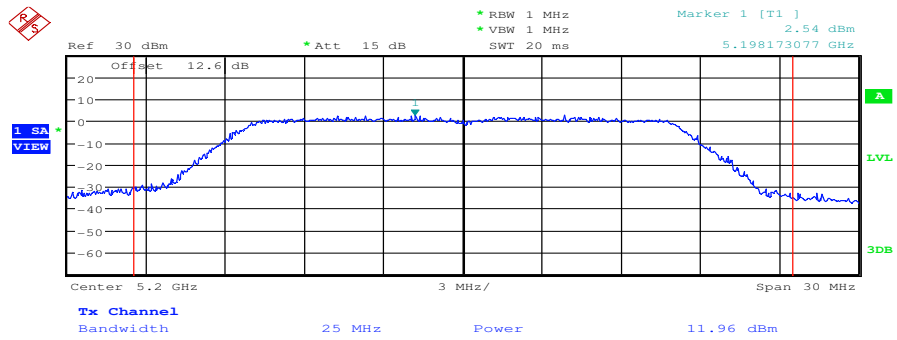

Date: 1.DEC.2010 14:06:12

Plot 6: OFDM – mode; middle channel – 5200 MHz; power index 21; 36 MBit/s

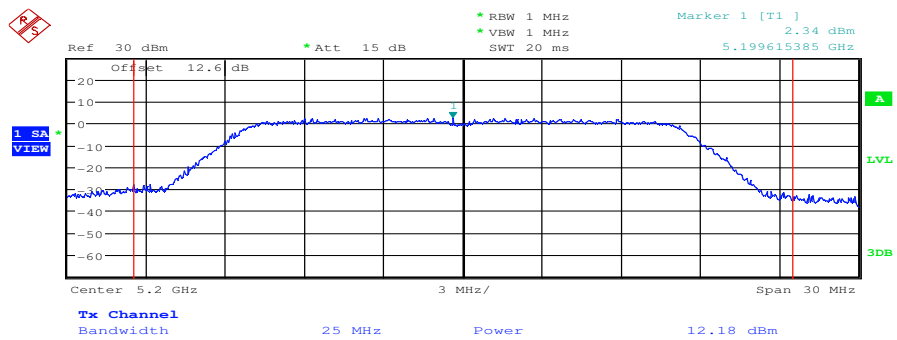

Date: 1.DEC.2010 14:08:15

Plot 7: OFDM – mode; middle channel – 5200 MHz; power index 21; 48 MBit/s

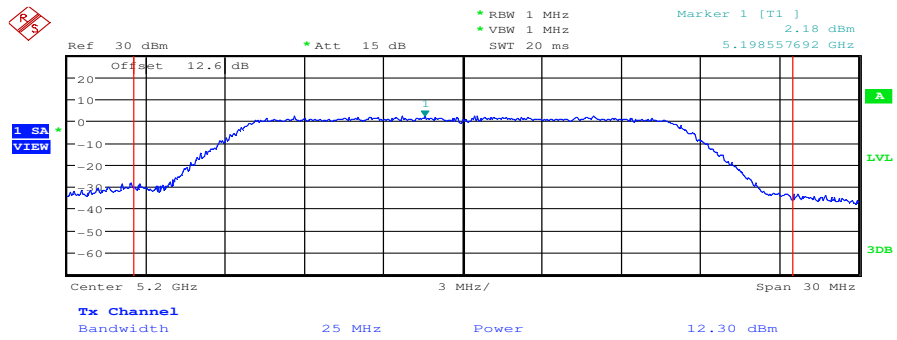

Date: 1.DEC.2010 14:10:12

Plot 8: OFDM – mode; middle channel – 5200 MHz; power index 21; 54 MBit/s

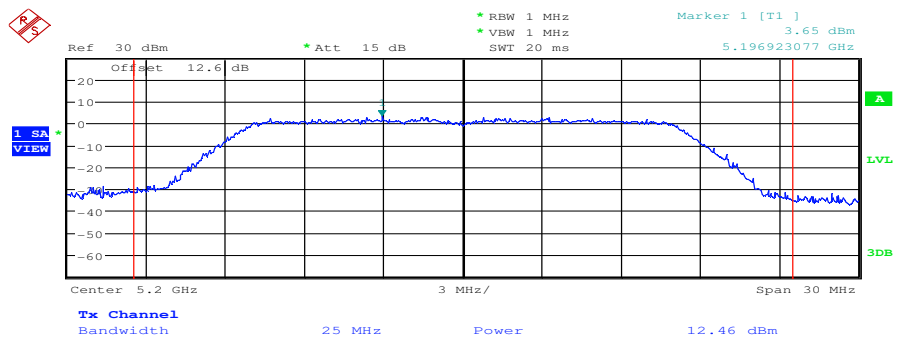

Date: 1.DEC.2010 14:12:35

OFDM – mode / n – mode:

Plot 1: OFDM – mode; middle channel – 5200 MHz; power index 21; mcs0

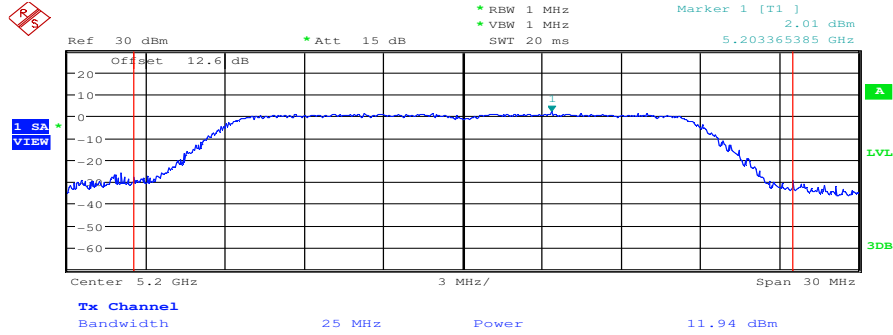

Date: 1.DEC.2010 14:20:25

Plot 2: OFDM – mode; middle channel – 5200 MHz; power index 21; mcs1

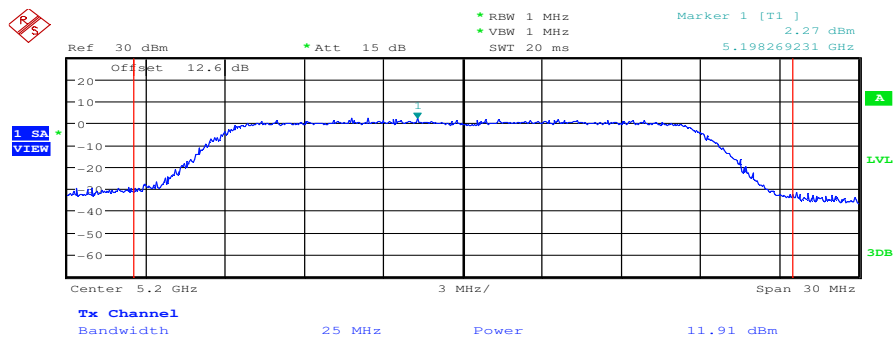

Date: 1.DEC.2010 14:27:52

Plot 3: OFDM – mode; middle channel – 5200 MHz; power index 21; mcs2

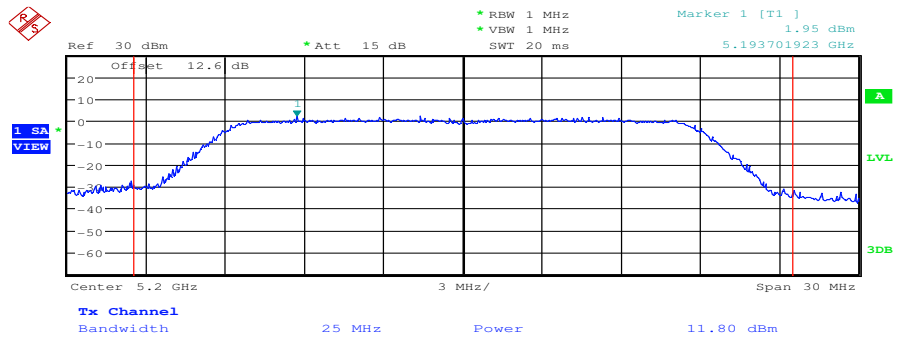

Date: 1.DEC.2010 14:29:23

Plot 4: OFDM – mode; middle channel – 5200 MHz; power index 21; mcs3

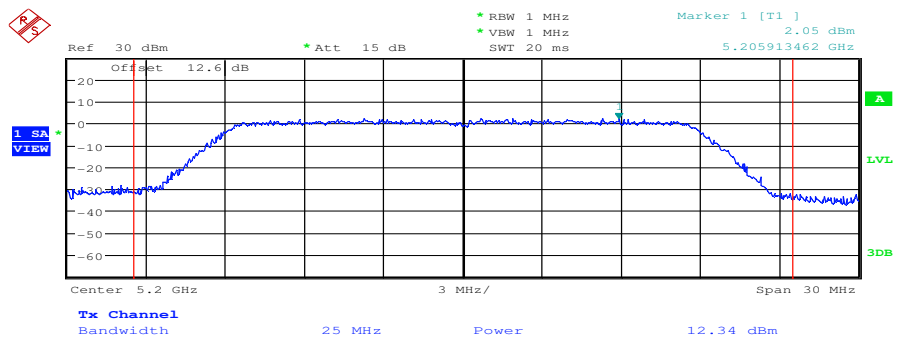

Date: 1.DEC.2010 14:30:49

Plot 5: OFDM – mode; middle channel – 5200 MHz; power index 21; mcs4

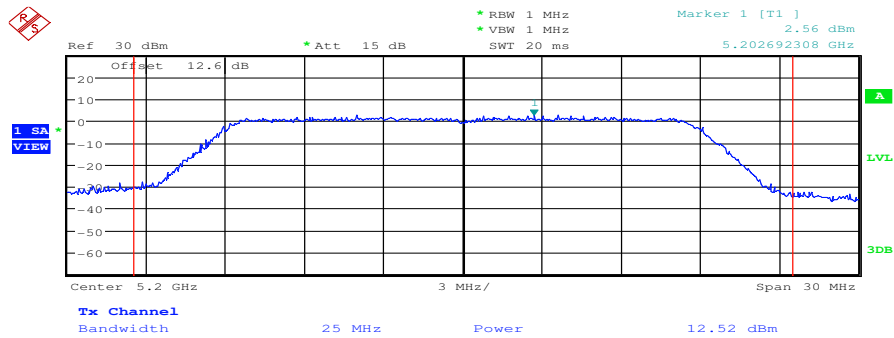

Date: 1.DEC.2010 14:32:30

Plot 6: OFDM – mode; middle channel – 5200 MHz; power index 21; mcs5

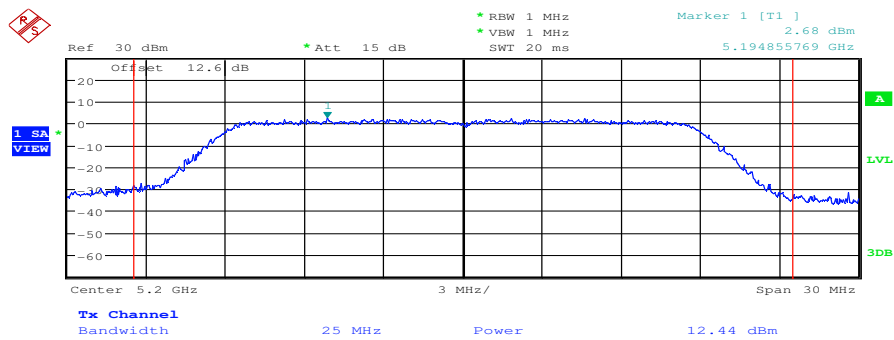

Date: 1.DEC.2010 14:34:03

Plot 7: OFDM – mode; middle channel – 5200 MHz; power index 21; mcs6

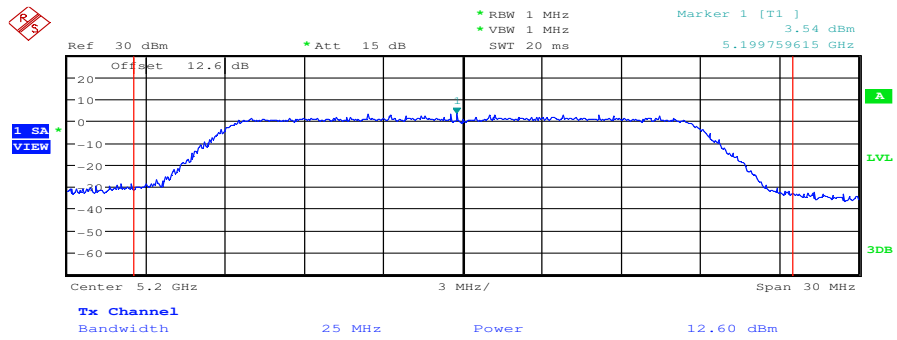

Date: 1.DEC.2010 14:35:46

Plot 8: OFDM – mode; middle channel – 5200 MHz; power index 21; mcs7

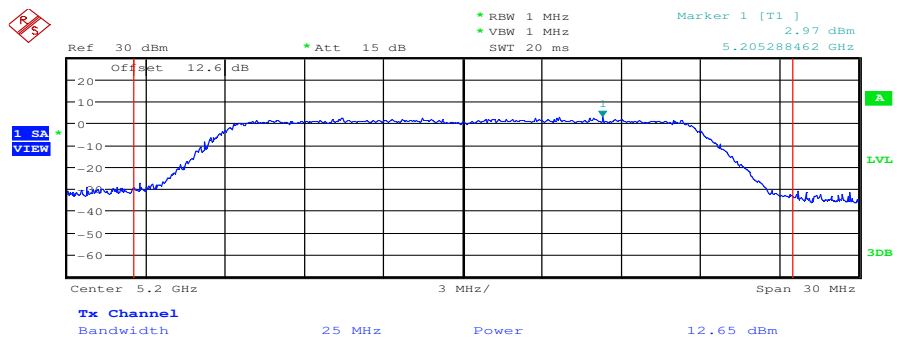

Date: 1.DEC.2010 14:37:43

Band 2: 5250 MHz – 5350 MHz

OFDM – mode / a – mode:

Plot 1: OFDM – mode; middle channel – 5280 MHz; power index 21; 6 MBit/s

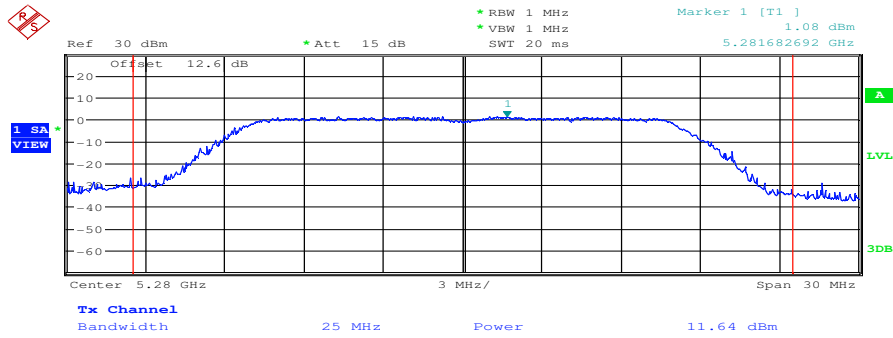

Date: 1.DEC.2010 14:45:19

Plot 2: OFDM – mode; middle channel – 5280 MHz; power index 21; 9 MBit/s

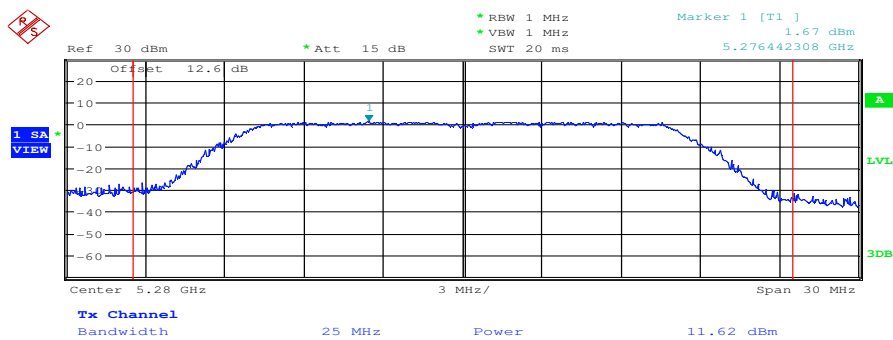

Date: 1.DEC.2010 14:47:03

Plot 3: OFDM – mode; middle channel – 5280 MHz; power index 21; 12 MBit/s

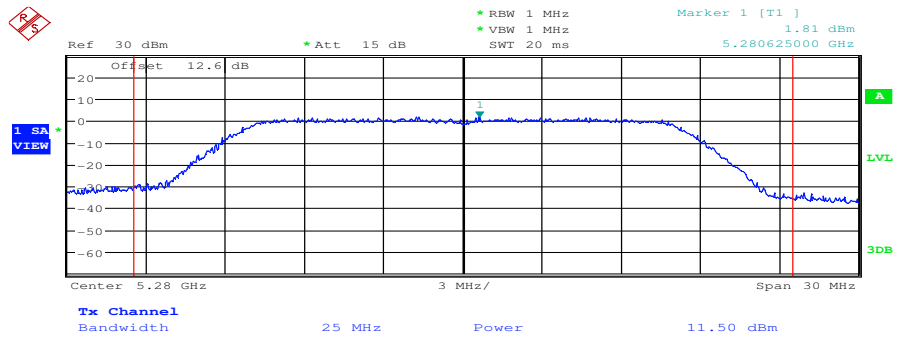

Date: 1.DEC.2010 14:48:34

Plot 4: OFDM – mode; middle channel – 5280 MHz; power index 21; 18 MBit/s

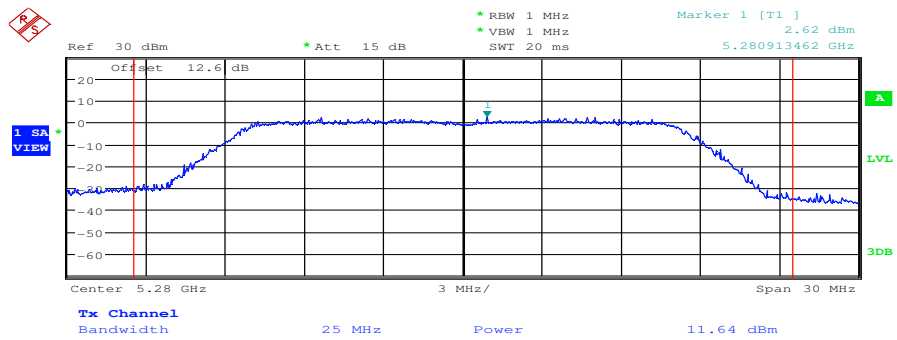

Date: 1.DEC.2010 14:50:27

Plot 5: OFDM – mode; middle channel – 5280 MHz; power index 21; 24 MBit/s

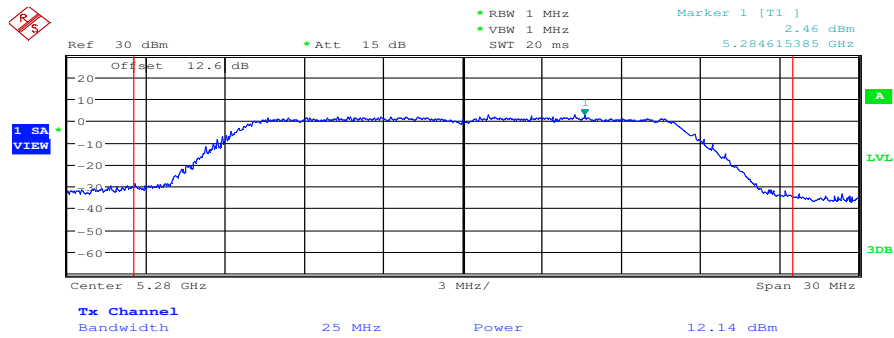

Date: 1.DEC.2010 14:52:26

Plot 6: OFDM – mode; middle channel – 5280 MHz; power index 21; 36 MBit/s

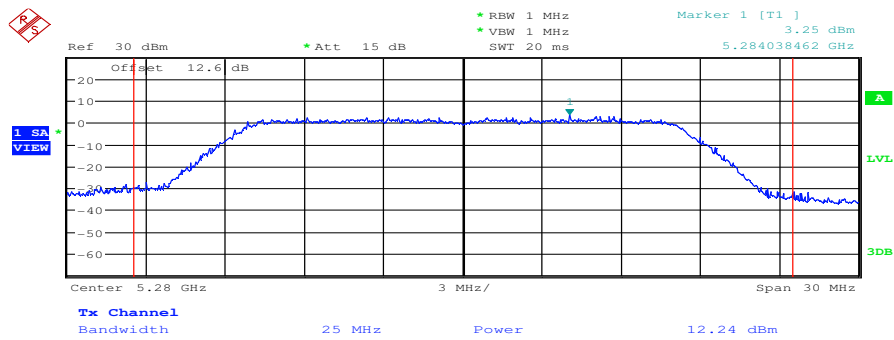

Date: 1.DEC.2010 14:54:33

Plot 7: OFDM – mode; middle channel – 5280 MHz; power index 21; 48 MBit/s

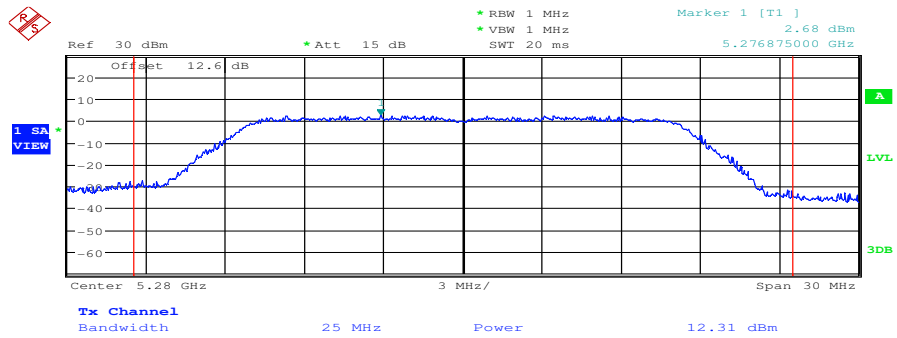

Date: 1.DEC.2010 14:56:35

Plot 8: OFDM – mode; middle channel – 5280 MHz; power index 21; 54 MBit/s

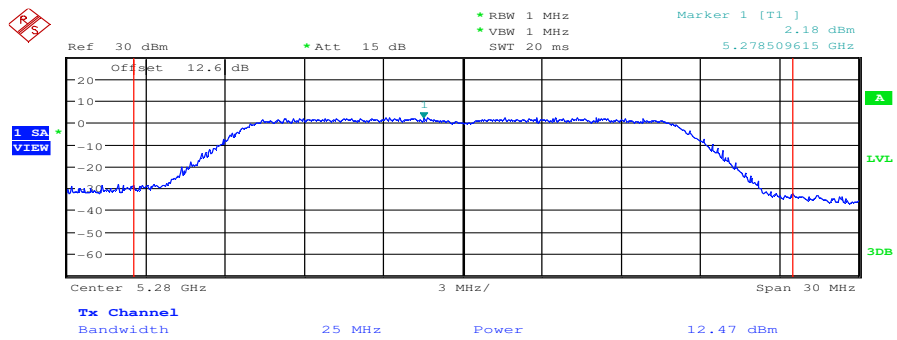

Date: 1.DEC.2010 14:59:02

OFDM – mode / n – mode:

Plot 1: OFDM – mode; middle channel – 5280 MHz; power index 21; mcs0

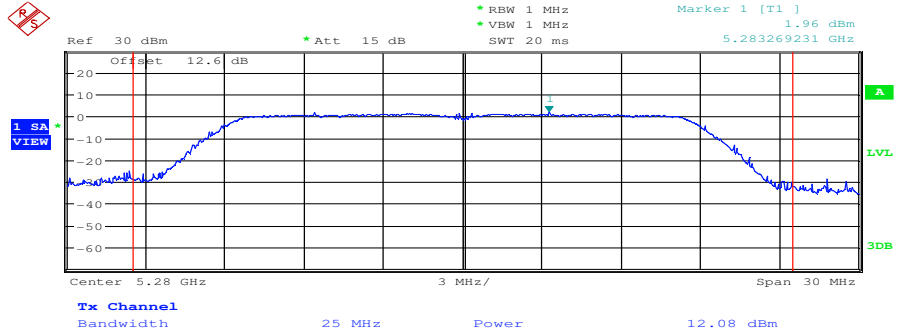

Date: 1.DEC.2010 15:07:12

Plot 2: OFDM – mode; middle channel – 5280 MHz; power index 21; mcs1

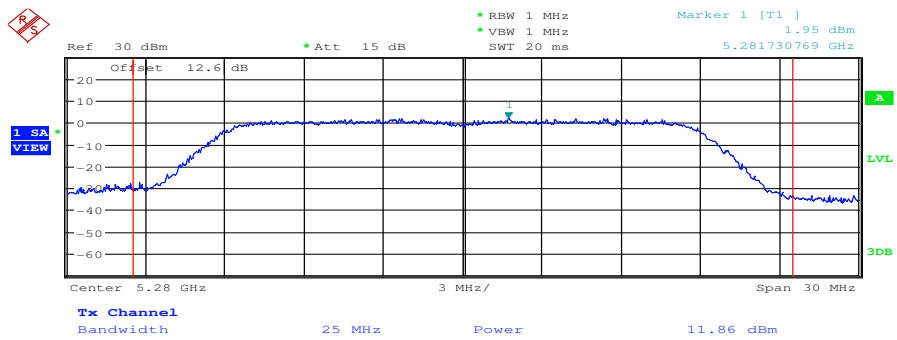

Date: 1.DEC.2010 15:08:50

Plot 3: OFDM – mode; middle channel – 5280 MHz; power index 21; mcs2

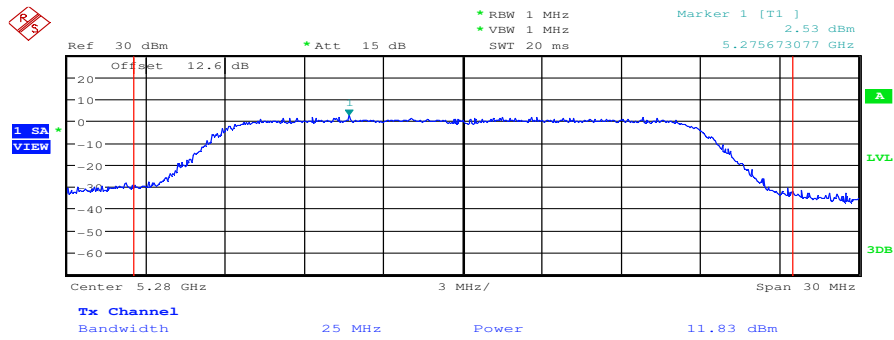

Date: 1.DEC.2010 15:10:18

Plot 4: OFDM – mode; middle channel – 5280 MHz; power index 21; mcs3

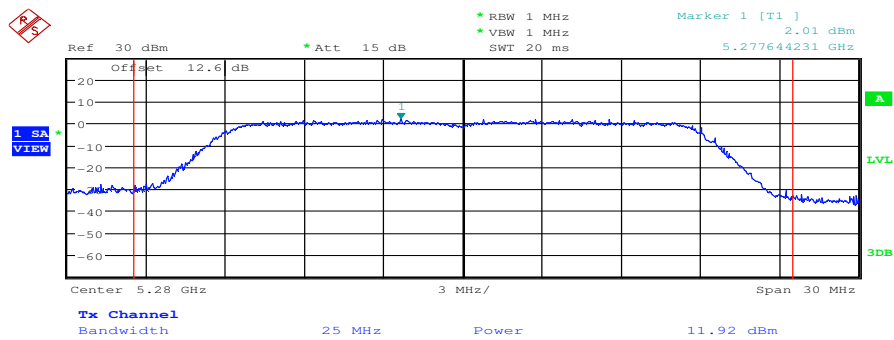

Date: 1.DEC.2010 15:12:07

Plot 5: OFDM – mode; middle channel – 5280 MHz; power index 21; mcs4

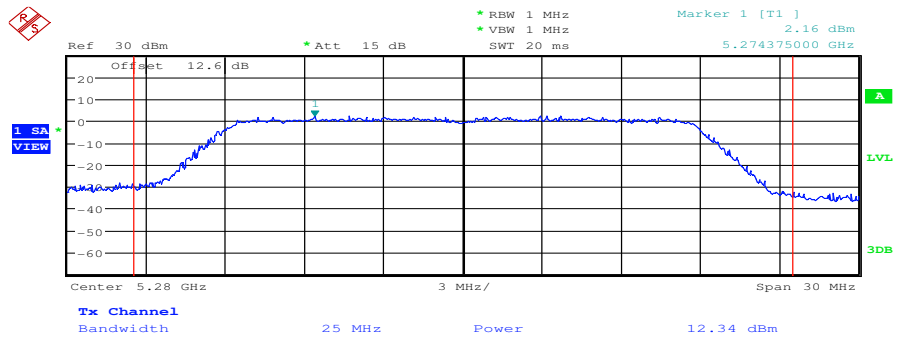

Date: 1.DEC.2010 15:13:39

Plot 6: OFDM – mode; middle channel – 5280 MHz; power index 21; mcs5

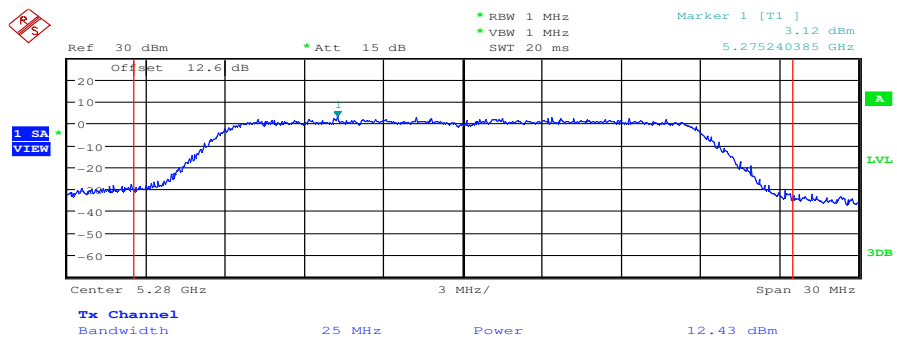

Date: 1.DEC.2010 15:15:28

Plot 7: OFDM – mode; middle channel – 5280 MHz; power index 21; mcs6

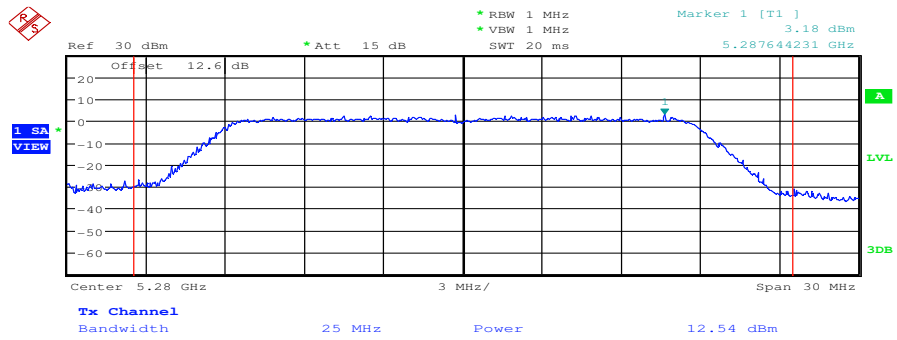

Date: 1.DEC.2010 15:17:38

Plot 8: OFDM – mode; middle channel – 5280 MHz; power index 21; mcs7

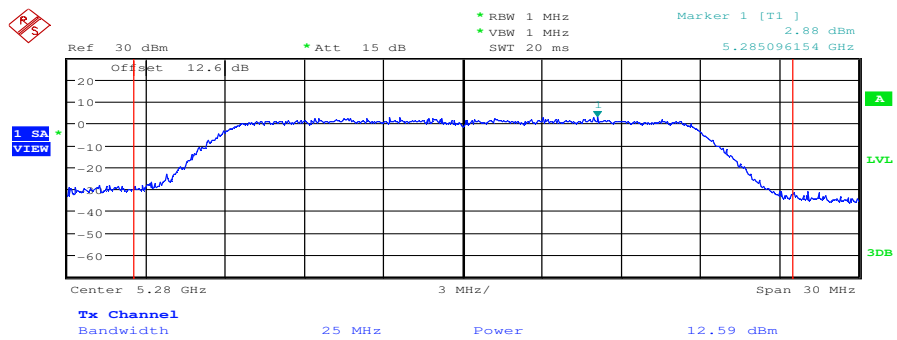

Date: 1.DEC.2010 15:19:22

9.3 Antenna power (conducted) & tolerance of antenna power

Measurement parameter:

Measurement parameter	
Detector:	RMS
Sweep time:	20s
Resolution bandwidth:	1 MHz
Video bandwidth:	3 MHz
Trace-Mode:	Zero span
Additional EUT parameters:	Power index 21 OFDM a & n – mode

Results: OFDM / g – mode, power index 21, 54 Mbit/s, band 1

<i>Technology / Frequency</i>	<i>Temperature / Voltage conditions</i>	<i>Output power conducted</i>
OFDM – 5180 MHz	T _{nom} / V _{nom}	-5.14
OFDM – 5200 MHz		-4.96
OFDM – 5240 MHz		-4.68
OFDM – 5180 MHz	T _{high} / V _{low}	-7.73
OFDM – 5200 MHz		-7.77
OFDM – 5240 MHz		-7.60
OFDM – 5180 MHz	T _{high} / V _{high}	-7.83
OFDM – 5200 MHz		-7.76
OFDM – 5240 MHz		-7.57
OFDM – 5180 MHz	T _{low} / V _{low}	-2.57
OFDM – 5200 MHz		-2.26
OFDM – 5240 MHz		-1.63
OFDM – 5180 MHz	T _{low} / V _{high}	-2.59
OFDM – 5200 MHz		-2.29
OFDM – 5240 MHz		-1.72

Results: OFDM / n – mode, power index 21, MCS 7, band 1

<i>Technology / Frequency</i>	<i>Temperature / Voltage conditions</i>	<i>Output power conducted</i>
OFDM – 5180 MHz	T _{nom} / V _{nom}	-5.22
OFDM – 5200 MHz		-5.07
OFDM – 5240 MHz		-4.70
OFDM – 5180 MHz	T _{high} / V _{low}	-7.69
OFDM – 5200 MHz		-7.71
OFDM – 5240 MHz		-7.58
OFDM – 5180 MHz	T _{high} / V _{high}	-7.72
OFDM – 5200 MHz		-7.74
OFDM – 5240 MHz		-7.60
OFDM – 5180 MHz	T _{low} / V _{low}	-2.41
OFDM – 5200 MHz		-2.34
OFDM – 5240 MHz		-1.74
OFDM – 5180 MHz	T _{low} / V _{high}	-2.43
OFDM – 5200 MHz		-2.38
OFDM – 5240 MHz		-1.79

Results: OFDM / g – mode, power index 21, 54 Mbit/s, band 2

<i>Technology / Frequency</i>	<i>Temperature / Voltage conditions</i>	<i>Output power conducted</i>
OFDM – 5260 MHz	T _{nom} / V _{nom}	-4.81
OFDM – 5280 MHz		-4.78
OFDM – 5320 MHz		-4.78
OFDM – 5260 MHz	T _{high} / V _{low}	-7.63
OFDM – 5280 MHz		-7.82
OFDM – 5320 MHz		-7.50
OFDM – 5260 MHz	T _{high} / V _{high}	-7.70
OFDM – 5280 MHz		-7.78
OFDM – 5320 MHz		-7.43
OFDM – 5260 MHz	T _{low} / V _{low}	-1.51
OFDM – 5280 MHz		-1.43
OFDM – 5320 MHz		-1.08
OFDM – 5260 MHz	T _{low} / V _{high}	-1.60
OFDM – 5280 MHz		-1.45
OFDM – 5320 MHz		-1.17

Results: OFDM / n – mode, power index 21, MCS, band 2

<i>Technology / Frequency</i>	<i>Temperature / Voltage conditions</i>	<i>Output power conducted</i>
OFDM – 5260 MHz	T _{nom} / V _{nom}	-4.68
OFDM – 5280 MHz		-4.93
OFDM – 5320 MHz		-4.62
OFDM – 5260 MHz	T _{high} / V _{low}	-7.73
OFDM – 5280 MHz		-7.71
OFDM – 5320 MHz		-7.54
OFDM – 5260 MHz	T _{high} / V _{high}	-7.75
OFDM – 5280 MHz		-7.69
OFDM – 5320 MHz		-7.49
OFDM – 5260 MHz	T _{low} / V _{low}	-1.38
OFDM – 5280 MHz		-1.24
OFDM – 5320 MHz		-1.06
OFDM – 5260 MHz	T _{low} / V _{high}	-1.42
OFDM – 5280 MHz		-1.33
OFDM – 5320 MHz		-1.08

All detected values are within +20 % and -80 % of the rated power values of each technology!

Limit:

Limit	max. 10 mW/MHz
--------------	----------------

Result: The result of the measurement is passed.

9.4 Frequency tolerance

Measurement parameter:

Measurement parameter	
Detector:	Peak
Sweep time:	Auto
Resolution bandwidth:	1 kHz
Video bandwidth:	1 kHz
Trace-Mode:	Max Hold
Additional EUT parameters:	Power index 21 OFDM

The results are valid for all technologies –OFDM a – mode and n – mode!
Both modes use the same oscillator!

Results (normal temperature / normal voltage): band 1

	<i>lowest channel</i> $f_{TX} = 5180 \text{ MHz}$	<i>mid channel</i> $f_{TX} = 5200 \text{ MHz}$	<i>highest channel</i> $f_{TX} = 5240 \text{ MHz}$
<i>Frequency offset [kHz]</i>	-2.4	-0.8	-2.0
<i>Offset [ppm] related to f_{TX}</i>	-0.5	-0.2	-0.4

Results (high temperature / low voltage): band 1

	<i>lowest channel</i> $f_{TX} = 5180 \text{ MHz}$	<i>mid channel</i> $f_{TX} = 5200 \text{ MHz}$	<i>highest channel</i> $f_{TX} = 5240 \text{ MHz}$
<i>Frequency offset [kHz]</i>	-21.6	-21.3	-22.3
<i>Offset [ppm] related to f_{TX}</i>	-4.2	-4.1	-4.3

Results (high temperature / high voltage): band 1

	<i>lowest channel</i> $f_{TX} = 5180 \text{ MHz}$	<i>mid channel</i> $f_{TX} = 5200 \text{ MHz}$	<i>highest channel</i> $f_{TX} = 5240 \text{ MHz}$
<i>Frequency offset [kHz]</i>	-21.6	-21.4	-22.1
<i>Offset [ppm] related to f_{TX}</i>	-4.2	-4.1	-4.2

Results (low temperature / low voltage): band 1

	<i>lowest channel f_{TX} = 5180 MHz</i>	<i>mid channel f_{TX} = 5200 MHz</i>	<i>highest channel f_{TX} = 5240 MHz</i>
<i>Frequency offset [kHz]</i>	28.0	29.2	28.4
<i>Offset [ppm] related to f_{TX}</i>	5.4	5.6	5.4

Results (low temperature / high voltage): band 1

	<i>lowest channel f_{TX} = 5180 MHz</i>	<i>mid channel f_{TX} = 5200 MHz</i>	<i>highest channel f_{TX} = 5240 MHz</i>
<i>Frequency offset [kHz]</i>	28.0	28.8	28.8
<i>Offset [ppm] related to f_{TX}</i>	5.4	5.5	5.5

Limit & Verdict:

Limit	< 20ppm
--------------	---------

Result: [The result of the measurement is passed.](#)

Results (normal temperature / normal voltage): band 2

	<i>lowest channel</i> $f_{TX} = 5260 \text{ MHz}$	<i>mid channel</i> $f_{TX} = 5280 \text{ MHz}$	<i>highest channel</i> $f_{TX} = 5320 \text{ MHz}$
<i>Frequency offset [kHz]</i>	-1.2	-1.6	-0.7
<i>Offset [ppm] related to f_{TX}</i>	-0.2	-0.3	-0.1

Results (high temperature / low voltage): band 2

	<i>lowest channel</i> $f_{TX} = 5260 \text{ MHz}$	<i>mid channel</i> $f_{TX} = 5280 \text{ MHz}$	<i>highest channel</i> $f_{TX} = 5320 \text{ MHz}$
<i>Frequency offset [kHz]</i>	-21.6	-22.3	-21.8
<i>Offset [ppm] related to f_{TX}</i>	-4.1	-4.2	-4.1

Results (high temperature / high voltage): band 2

	<i>lowest channel</i> $f_{TX} = 5260 \text{ MHz}$	<i>mid channel</i> $f_{TX} = 5280 \text{ MHz}$	<i>highest channel</i> $f_{TX} = 5320 \text{ MHz}$
<i>Frequency offset [kHz]</i>	-21.7	-22.0	-21.8
<i>Offset [ppm] related to f_{TX}</i>	-4.1	-4.2	-4.1

Results (low temperature / low voltage): band 2

	<i>lowest channel</i> $f_{TX} = 5260 \text{ MHz}$	<i>mid channel</i> $f_{TX} = 5280 \text{ MHz}$	<i>highest channel</i> $f_{TX} = 5320 \text{ MHz}$
<i>Frequency offset [kHz]</i>	30.0	29.8	30.8
<i>Offset [ppm] related to f_{TX}</i>	5.7	5.6	5.8

Results (low temperature / high voltage): band 2

	<i>lowest channel</i> $f_{TX} = 5260 \text{ MHz}$	<i>mid channel</i> $f_{TX} = 5280 \text{ MHz}$	<i>highest channel</i> $f_{TX} = 5320 \text{ MHz}$
<i>Frequency offset [kHz]</i>	29.6	30.0	30.4
<i>Offset [ppm] related to f_{TX}</i>	5.6	5.7	5.7

Limit & Verdict:

Limit	< 20ppm
--------------	---------

Result: The result of the measurement is passed.

9.5 Modulation method

OFDM technology with BPSK, QPSK, 16 QAM and 64 QAM modulation.

Result: [The result of the measurement is passed.](#)

9.6 Spurious emission intensity – conducted & out - band leakage power

Measurement parameter:

Measurement parameter	
Detector:	Peak
Sweep time:	Auto
Resolution bandwidth:	f <= 1GHz : 1 MHz f > 1GHz : 1 MHz
Video bandwidth:	f <= 1GHz : 10 kHz f > 1GHz : 10 kHz
Span:	See plot
Trace-Mode:	Max Hold
Additional EUT parameters:	Test mode (modulated carrier) OFDM Power index 21

Results:

OFDM / a – mode band 1	lowest channel f _{TX} = 5180 MHz		mid channel f _{TX} = 5200 MHz		highest channel f _{TX} = 5240 MHz	
	F [MHz]	Level [dBm]	F [MHz]	Level [dBm]	F [MHz]	Level [dBm]
Found peaks:	No critical peaks found (see plots).					
OFDM / a – mode band 2	lowest channel f _{TX} = 5260 MHz		mid channel f _{TX} = 5280 MHz		highest channel f _{TX} = 5320 MHz	
	F [MHz]	Level [dBm]	F [MHz]	Level [dBm]	F [MHz]	Level [dBm]
Found peaks:	No critical peaks found (see plots).					

OFDM / n – mode band 1	lowest channel f _{TX} = 5180 MHz		mid channel f _{TX} = 5200 MHz		highest channel f _{TX} = 5240 MHz	
	F [MHz]	Level [dBm]	F [MHz]	Level [dBm]	F [MHz]	Level [dBm]
Found peaks:	No critical peaks found (see plots).					
OFDM / n – mode band 2	lowest channel f _{TX} = 5260 MHz		mid channel f _{TX} = 5280 MHz		highest channel f _{TX} = 5320 MHz	
	F [MHz]	Level [dBm]	F [MHz]	Level [dBm]	F [MHz]	Level [dBm]
Found peaks:	No critical peaks found (see plots).					

Limit: band 1

Limit	<p>30 MHz <= f <= 5135 MHz: 2.5uW (-26.02 dBm) 5135 MHz <= f <= 5142 MHz: 2.5uW (-26.02 dBm) 5142 MHz <= f <= 5150 MHz: 15uW (-18.24 dBm) 5250 MHz : 1mW (0 dBm) 5251 MHz : 0.1mW (-10 dBm) 5260 MHz : 15.8mW (-18.01 dBm) 5266.7 MHz : 15.8mW (-26.02 dBm) 5266.7 MHz <= f <= 5365 MHz: 2.5uW (-26.02dBm) 5365 MHz <= f <= 26000 MHz: 2.5uW (-26.02dBm)</p>
--------------	--

Limit: band 2

Limit	<p>30 MHz <= f <= 5135 MHz: 2.5uW (-26.02 dBm) 5135 MHz <= f <= 5233.3 MHz: 2.5uW (-26.02 dBm) 5233.3 MHz <= f <= 5240 MHz: 15uW (-18.24 dBm) 5240 MHz <= f <= 5249 MHz: 0.1mW (-10 dBm) 5249 MHz <= f <= 5250 MHz: 10mW (0 dBm) 5250 MHz <= f <= 5350 MHz: 10mW (0 dBm) 5350 MHz: 2.5uW (-26.02 dBm) 5350 MHz <= f <= 5360 MHz: 2.5uW (-26.02dBm) 5350 MHz <= f <= 26000 MHz: 2.5uW (-26.02dBm)</p>
--------------	--

Result: [The result of the measurement is passed.](#)

Plots: OFDM / a – mode, power index 21, 54 MBit/s, band 1

Plot 1: OFDM, lowest channel, 30 MHz – 1000 MHz

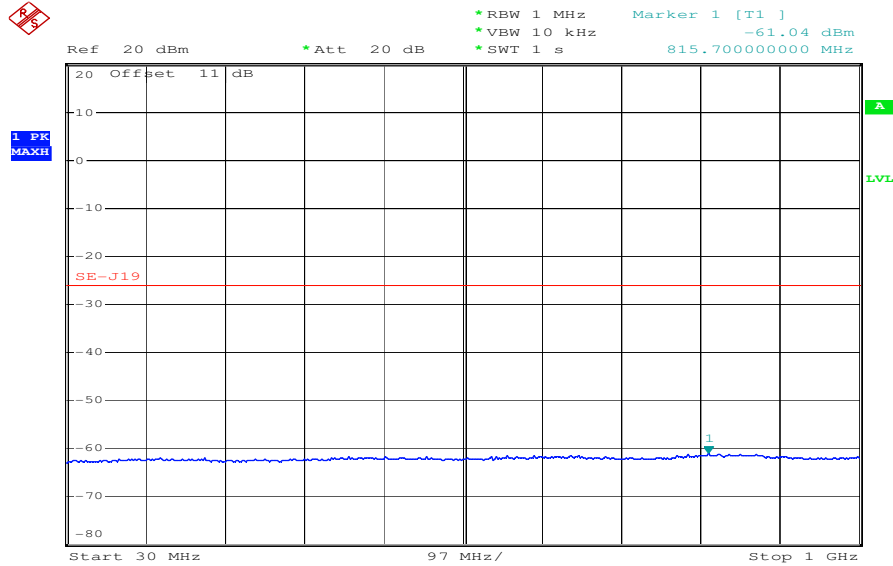

Date: 24.FEB.2011 11:52:33

Plot 2: OFDM, lowest channel, 1000 MHz – 5135 MHz

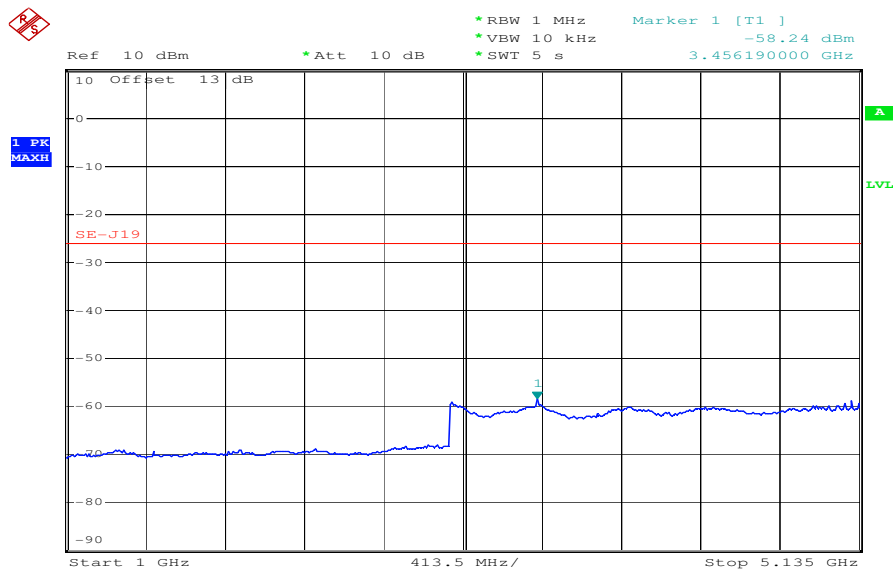

Date: 24.FEB.2011 12:03:22

Plot 3: OFDM, lowest channel, 5135 MHz – 5365 MHz

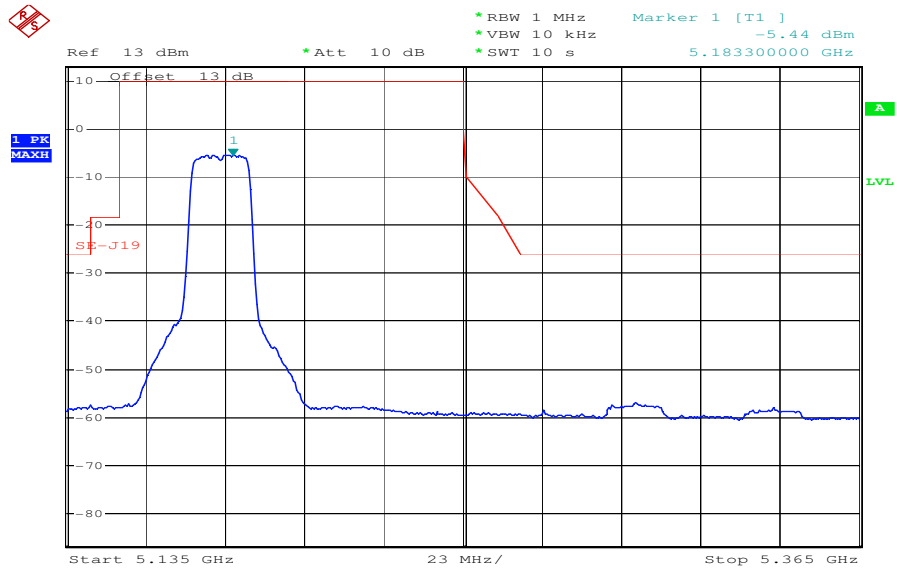

Date: 24.FEB.2011 12:06:50

Plot 4: OFDM, lowest channel, 5365 MHz – 26000 MHz

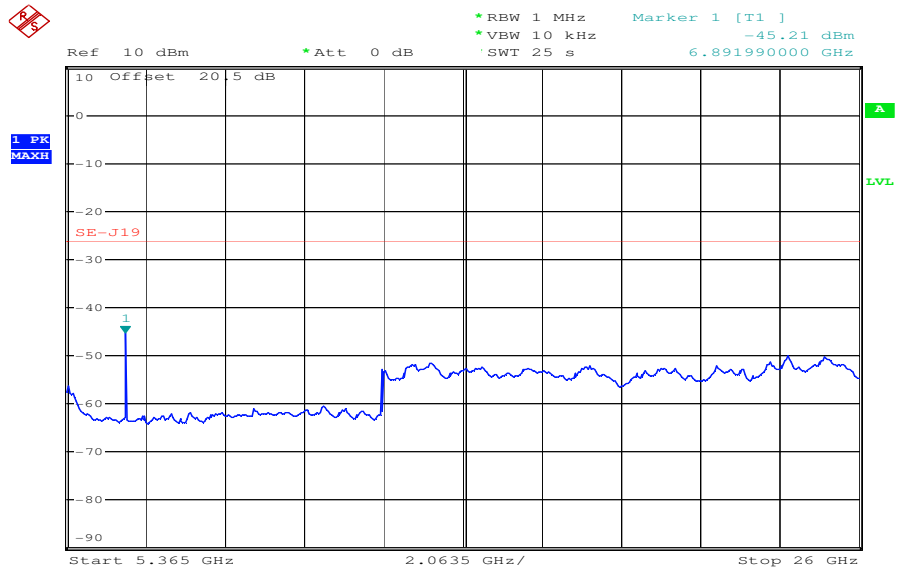

Date: 24.FEB.2011 12:15:06

Plot 5: OFDM, middle channel, 30 MHz – 1000 MHz

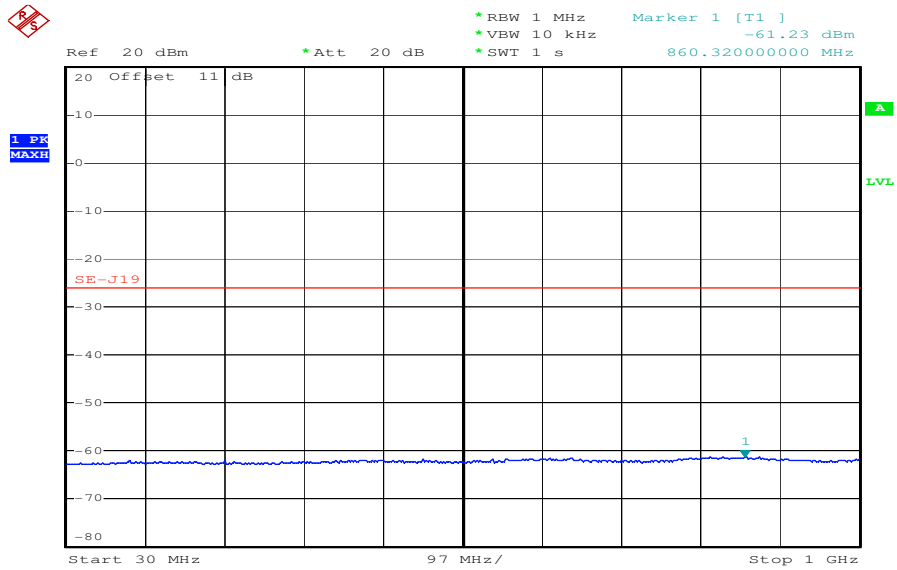

Date: 24.FEB.2011 11:54:59

Plot 6: OFDM, middle channel, 1000 MHz – 5135 MHz

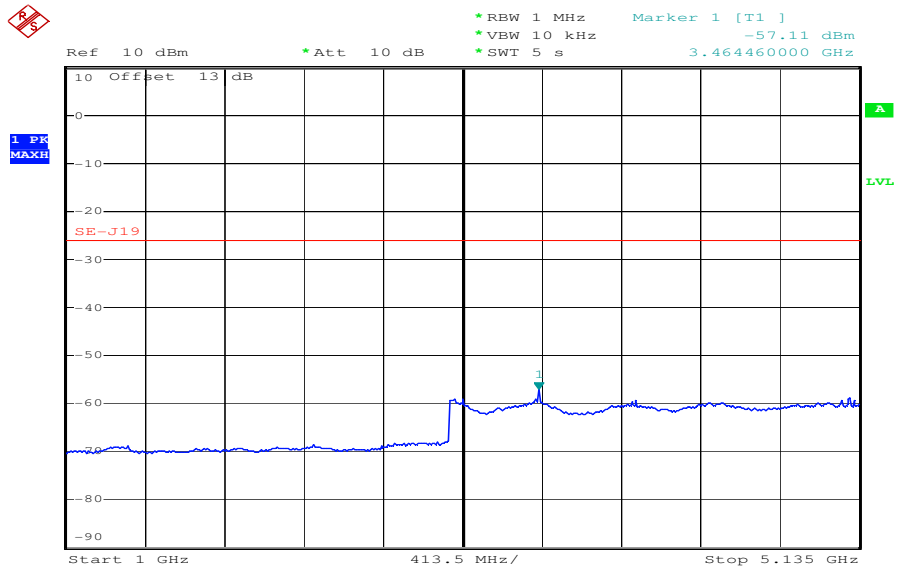

Date: 24.FEB.2011 12:01:32

Plot 7: OFDM, middle channel, 5135 MHz – 5365 MHz

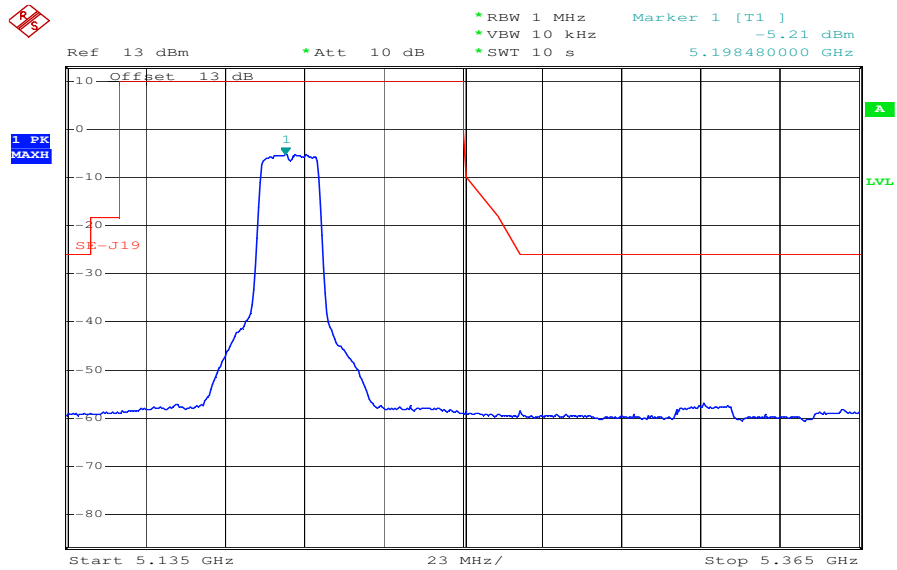

Date: 24.FEB.2011 12:08:20

Plot 8: OFDM, middle channel, 5365 MHz – 26000 MHz

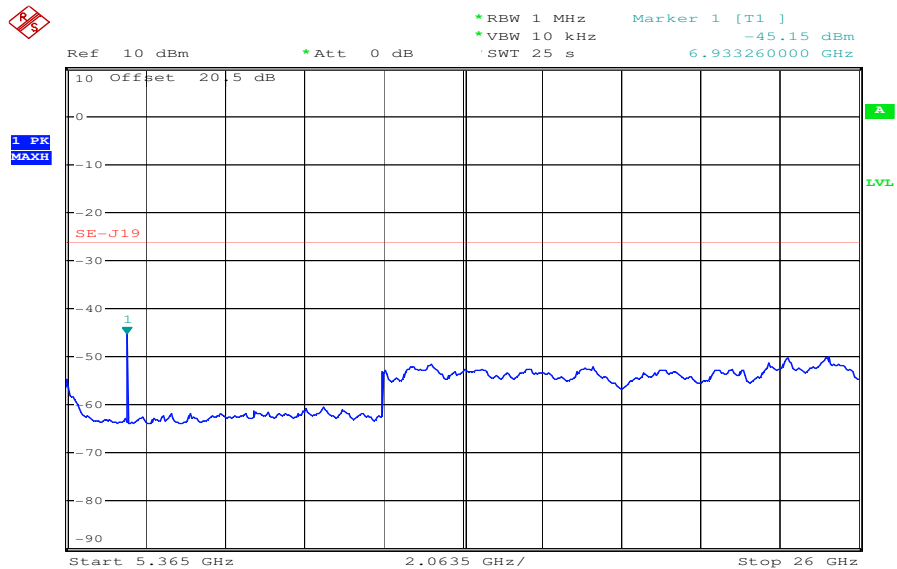

Date: 24.FEB.2011 12:17:43

Plot 9: OFDM, highest channel, 30 MHz – 1000 MHz

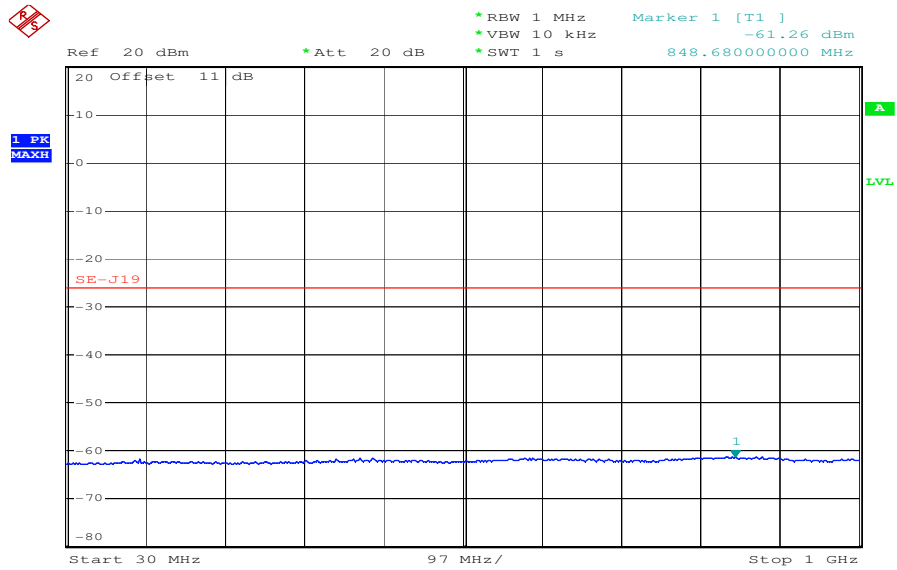

Date: 24.FEB.2011 11:56:49

Plot 10: OFDM, highest channel, 1000 MHz – 5135 MHz

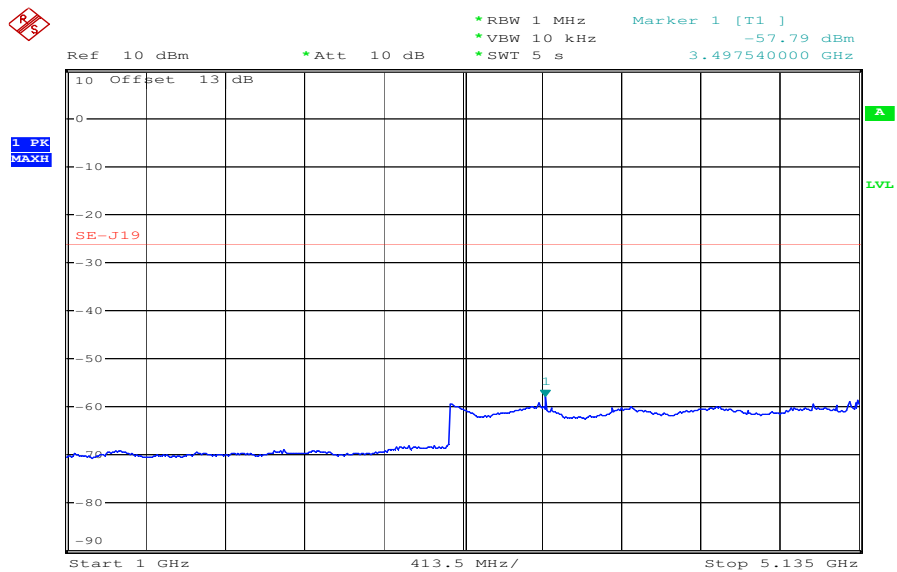

Date: 24.FEB.2011 12:00:15

Plot 11: OFDM, highest channel, 5135 MHz – 5365 MHz

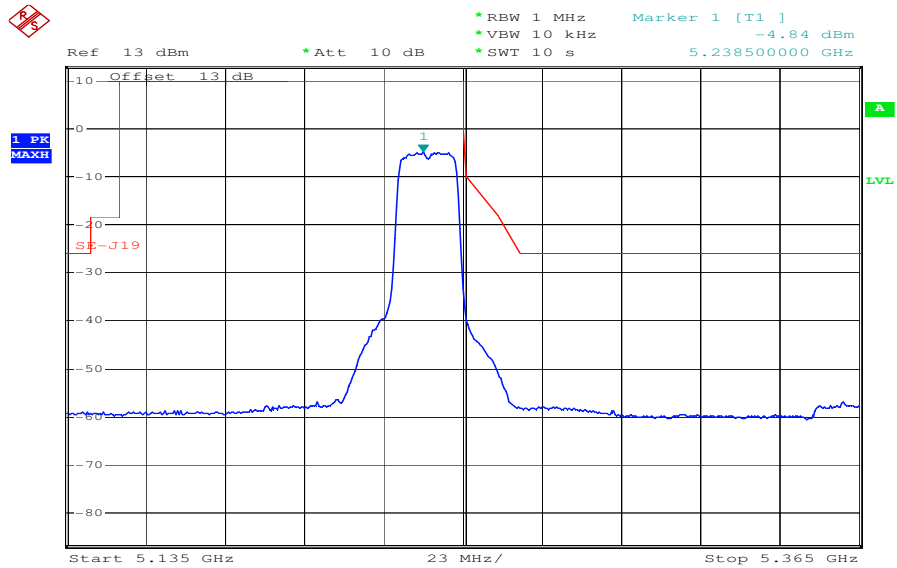

Date: 24.FEB.2011 12:11:54

Plot 12: OFDM, highest channel, 5365 MHz – 26000 MHz

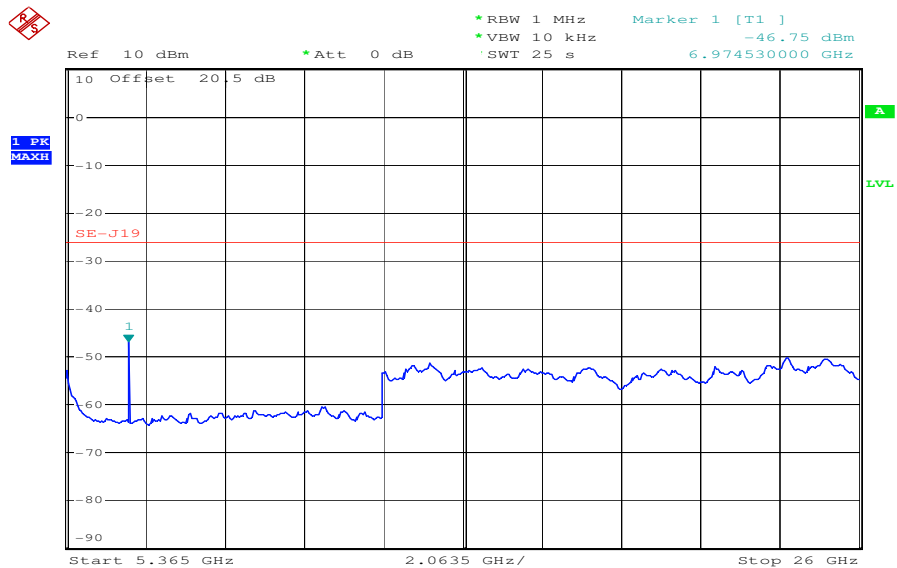

Date: 24.FEB.2011 12:20:17

Plots: OFDM / n – mode, power index 21, MCS 7, band 1

Plot 1: OFDM, lowest channel, 30 MHz – 1000 MHz

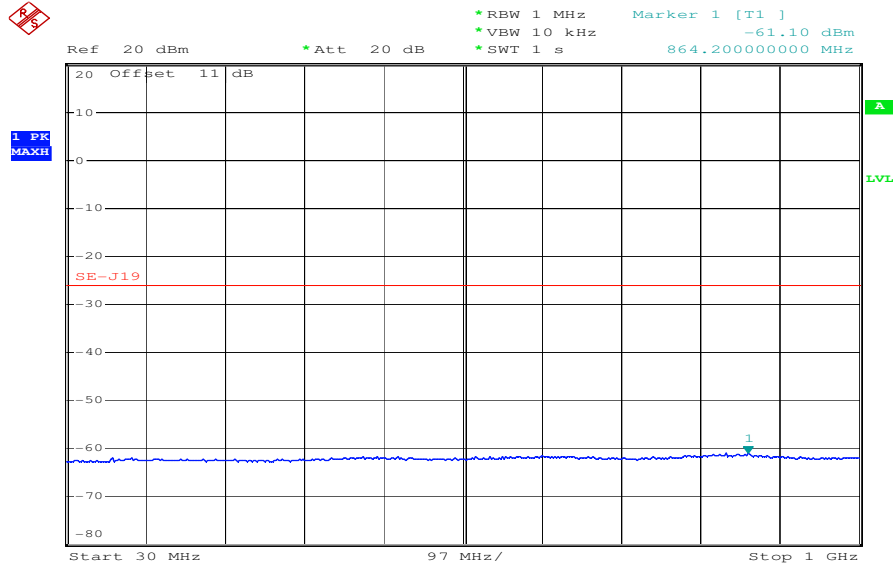

Date: 24.FEB.2011 11:53:32

Plot 2: OFDM, lowest channel, 1000 MHz – 5135 MHz

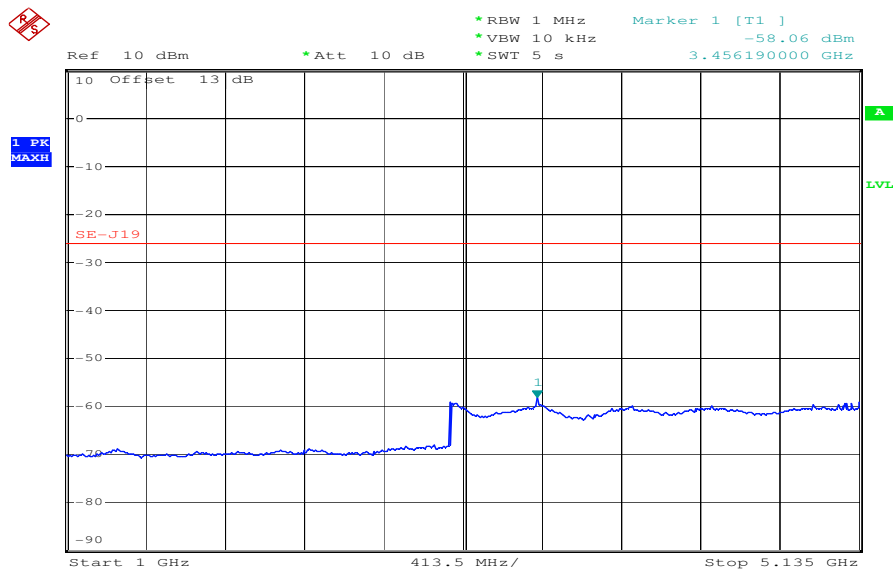

Date: 24.FEB.2011 12:02:48

Plot 3: OFDM, lowest channel, 5135 MHz – 5365 MHz

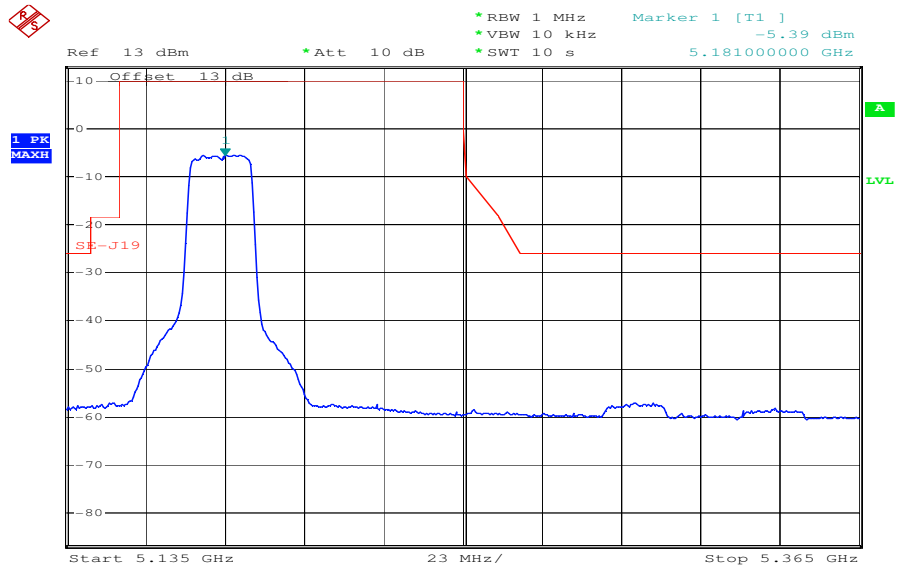

Date: 24.FEB.2011 12:07:35

Plot 4: OFDM, lowest channel, 5365 MHz – 26000 MHz

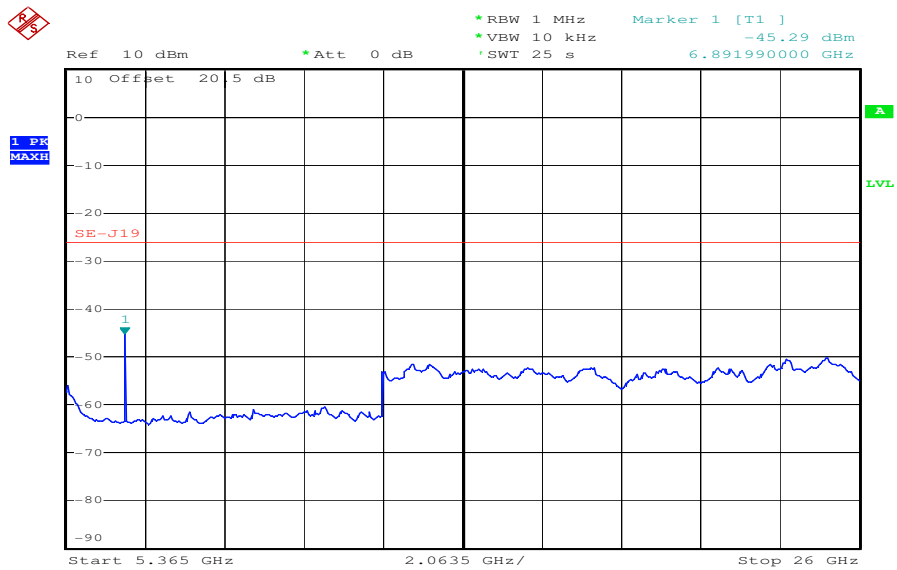

Date: 24.FEB.2011 12:16:25

Plot 5: OFDM, middle channel, 30 MHz – 1000 MHz

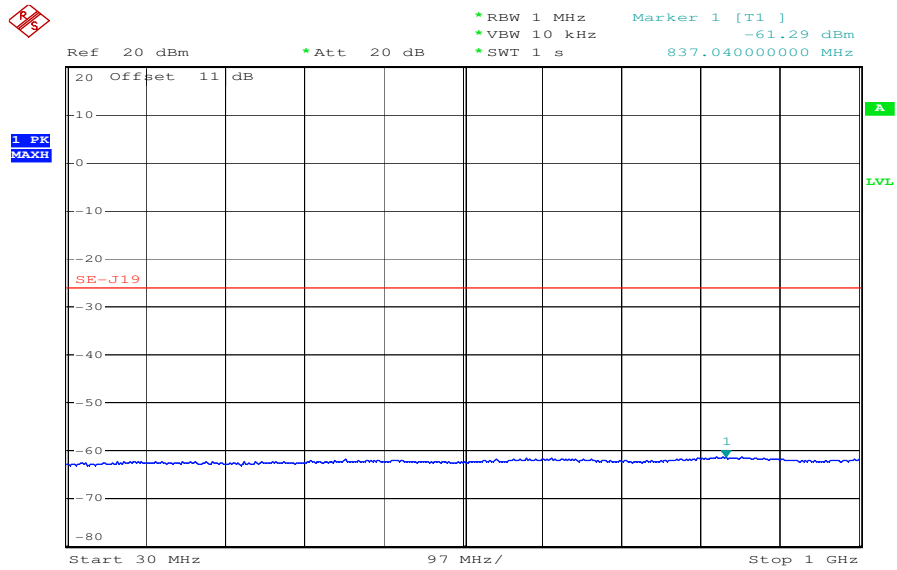

Date: 24.FEB.2011 11:55:41

Plot 6: OFDM, middle channel, 1000 MHz – 5135 MHz

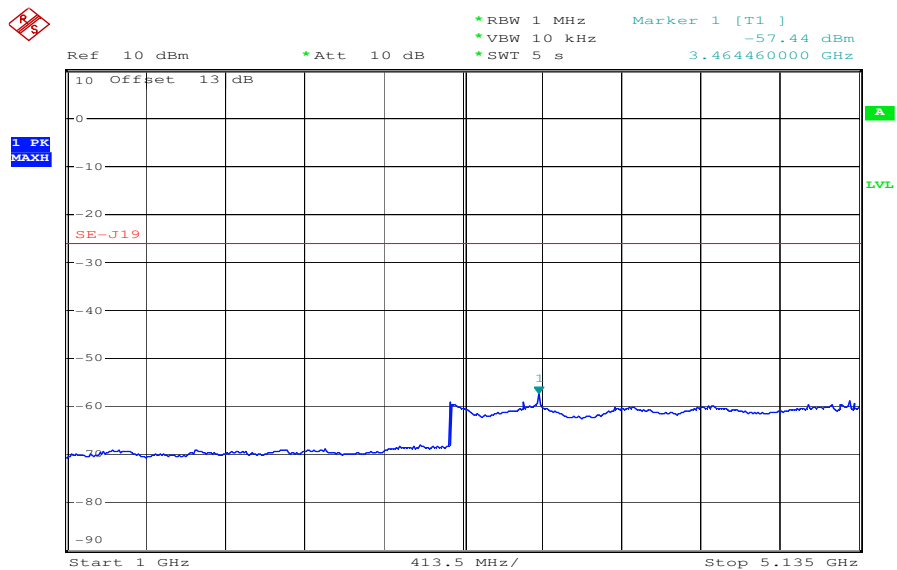

Date: 24.FEB.2011 12:02:15

Plot 7: OFDM, middle channel, 5135 MHz – 5365 MHz

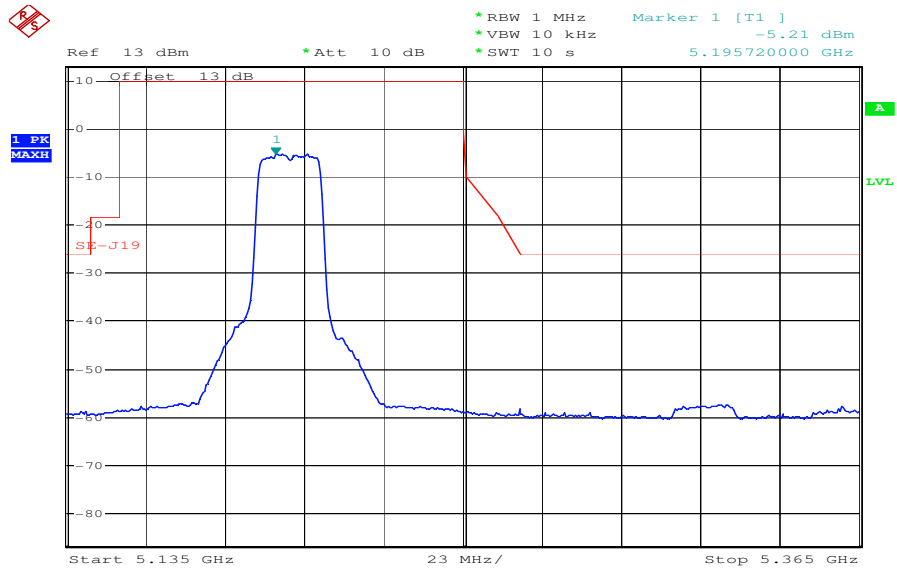

Date: 24.FEB.2011 12:11:11

Plot 8: OFDM, middle channel, 5365 MHz – 26000 MHz

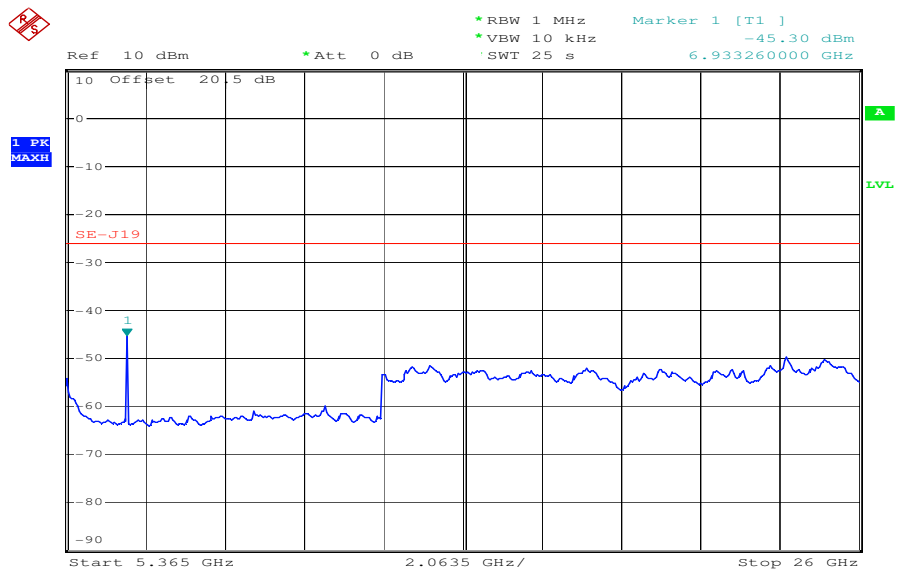

Date: 24.FEB.2011 12:18:58

Plot 9: OFDM, highest channel, 30 MHz – 1000 MHz

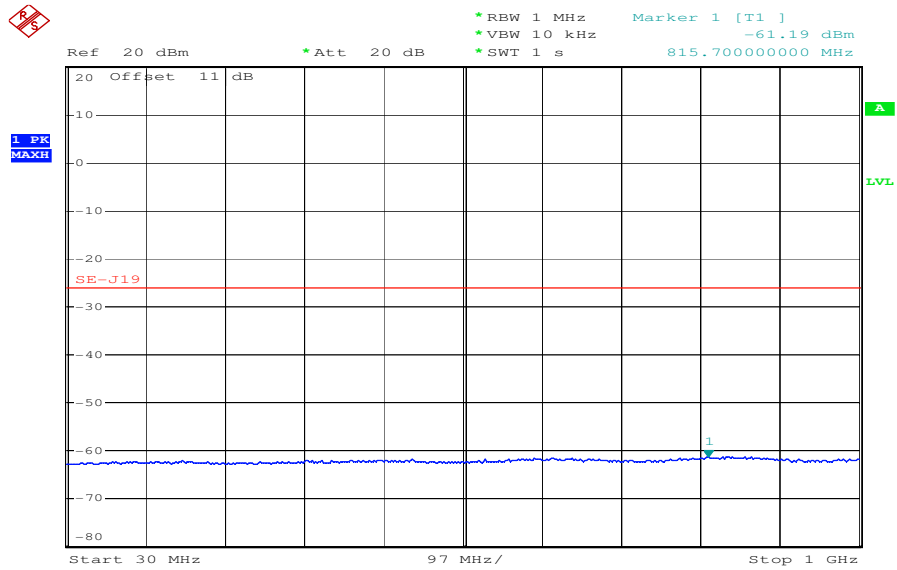

Date: 24.FEB.2011 11:57:44

Plot 10: OFDM, highest channel, 1000 MHz – 5135 MHz

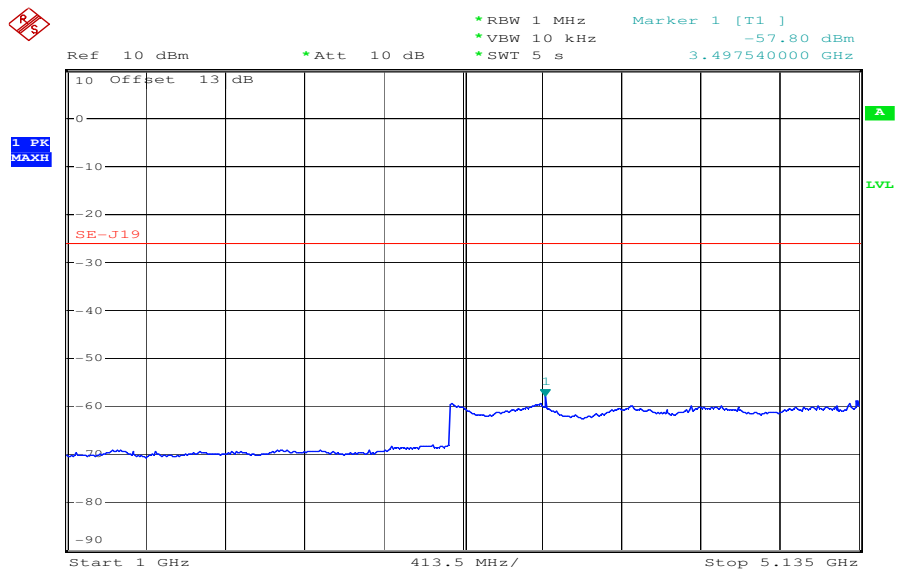

Date: 24.FEB.2011 11:59:39

Plot 11: OFDM, highest channel, 5135 MHz – 5365 MHz

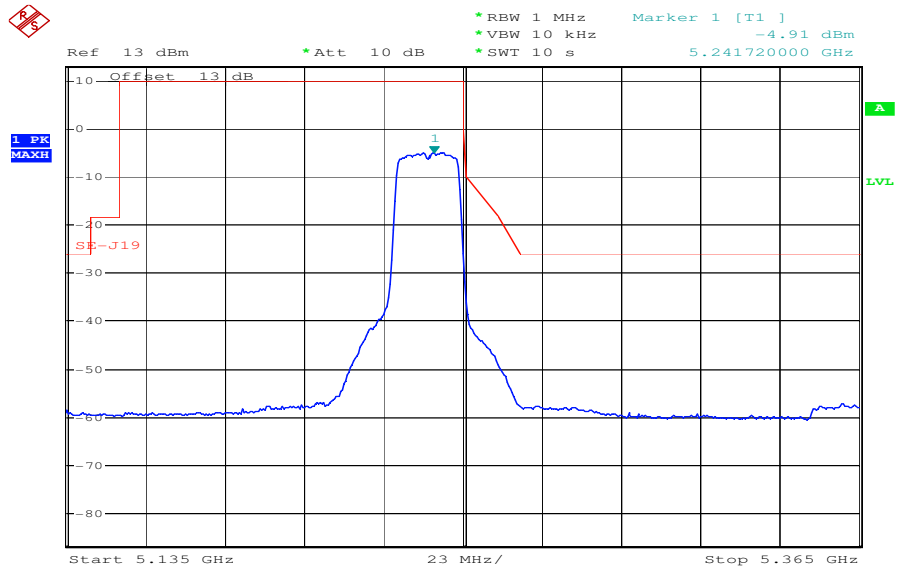

Date: 24.FEB.2011 12:12:35

Plot 12: OFDM, highest channel, 5365 MHz – 26000 MHz

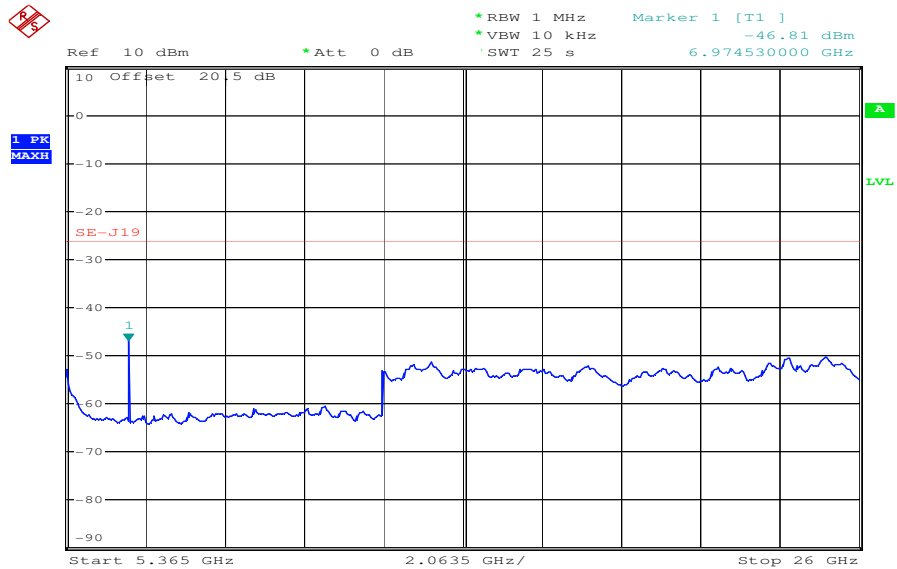

Date: 24.FEB.2011 12:21:32

Plots: OFDM / a – mode, power index 21, 54 MBit/s, band 2

Plot 1: OFDM, lowest channel, 30 MHz – 1000 MHz

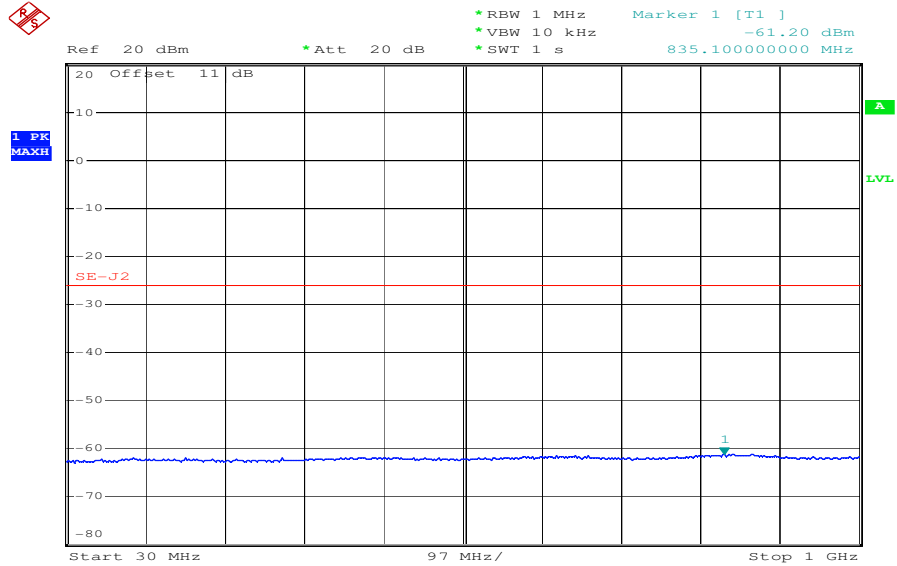

Date: 24.FEB.2011 13:44:41

Plot 2: OFDM, lowest channel, 1000 MHz – 5233.3 MHz

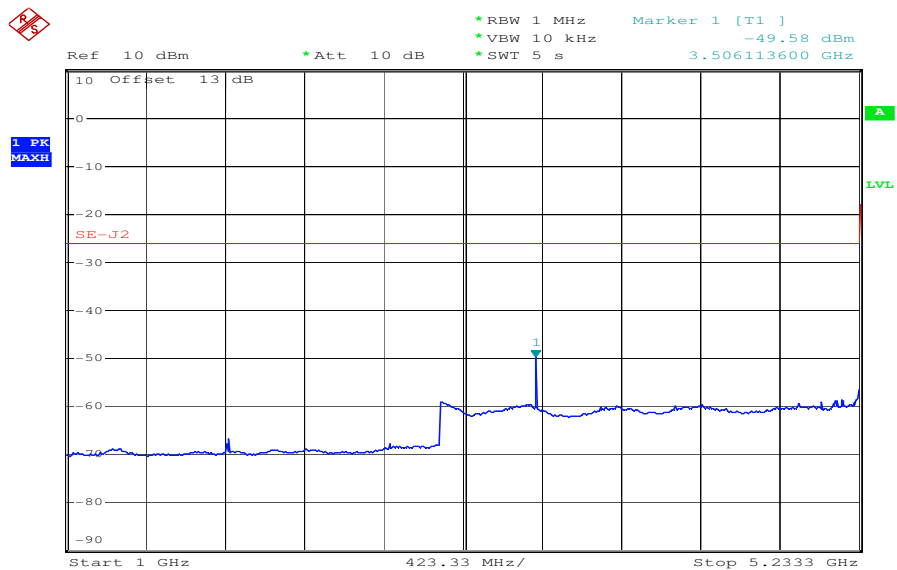

Date: 24.FEB.2011 14:04:57

Plot 3: OFDM, lowest channel, 5233.3 MHz – 5365 MHz

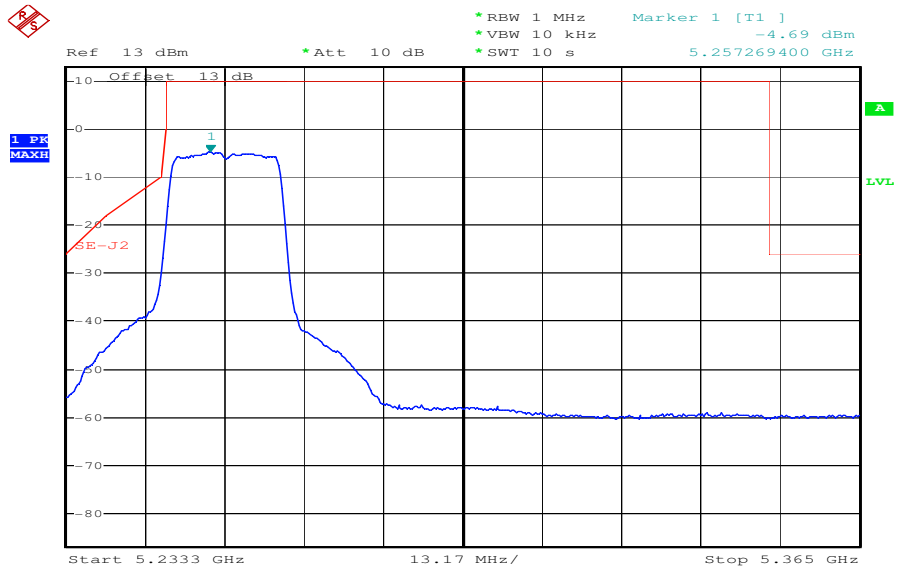

Date: 24.FEB.2011 14:10:50

Plot 4: OFDM, lowest channel, 5365 MHz – 26000 MHz

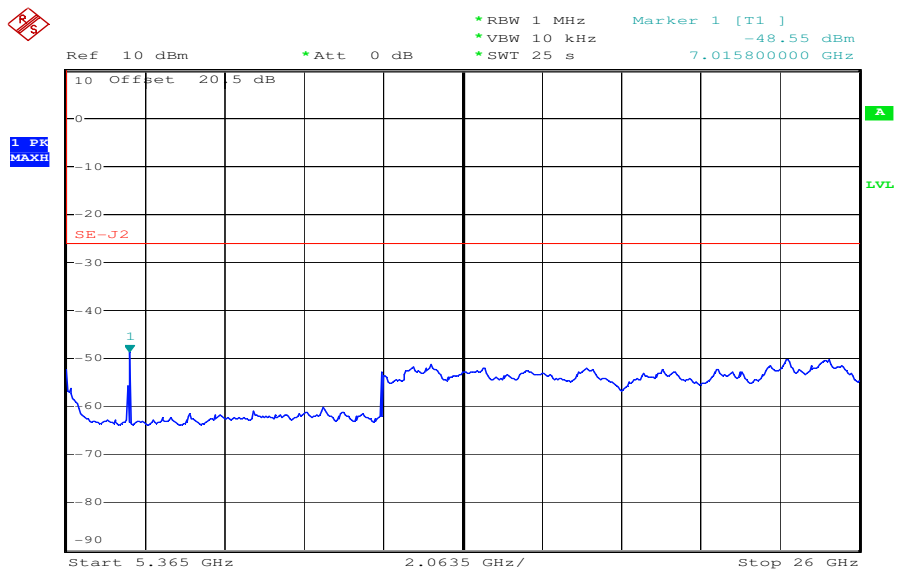

Date: 24.FEB.2011 14:19:48

Plot 5: OFDM, middle channel, 30 MHz – 1000 MHz

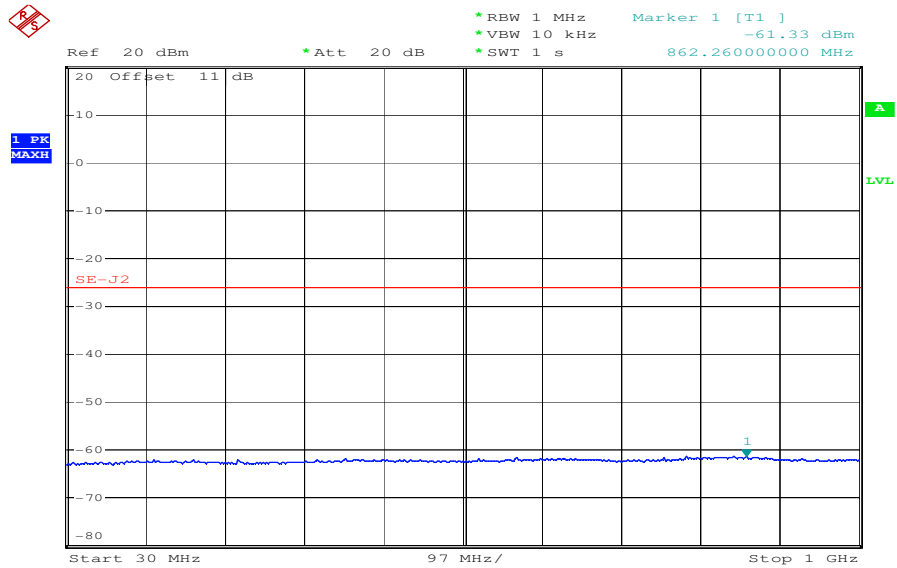

Date: 24.FEB.2011 13:46:12

Plot 6: OFDM, middle channel, 1000 MHz – 5233.3 MHz

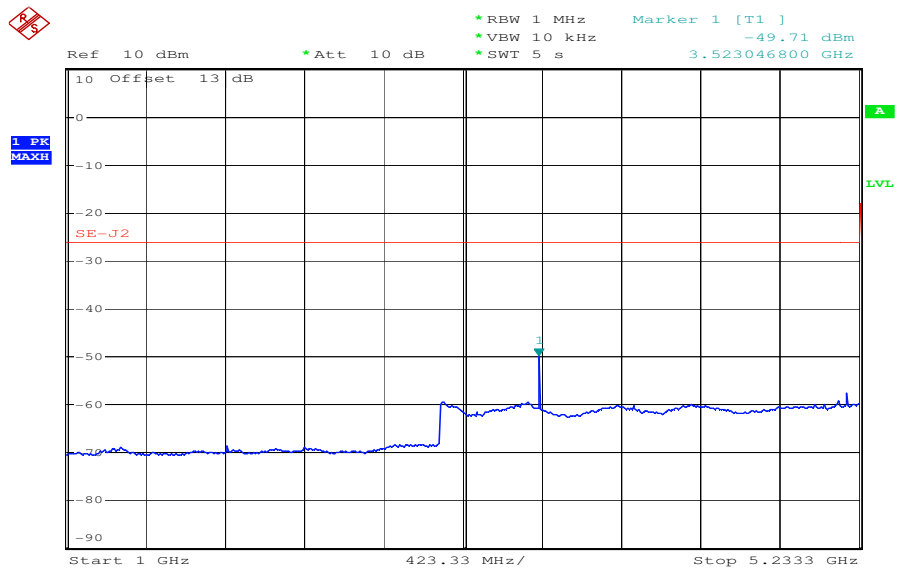

Date: 24.FEB.2011 13:50:54

Plot 7: OFDM, middle channel, 5233.3 MHz – 5365 MHz

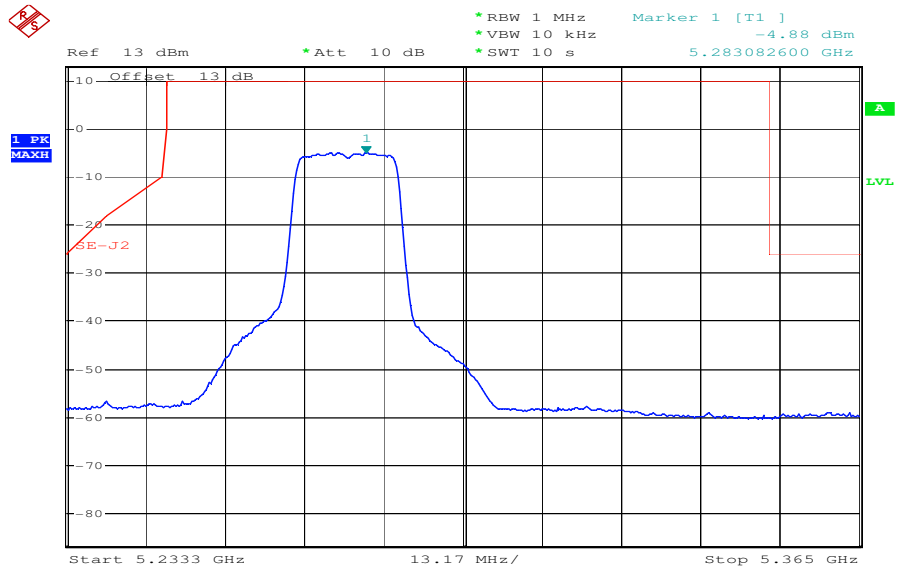

Date: 24.FEB.2011 14:14:45

Plot 8: OFDM, middle channel, 5365 MHz – 26000 MHz

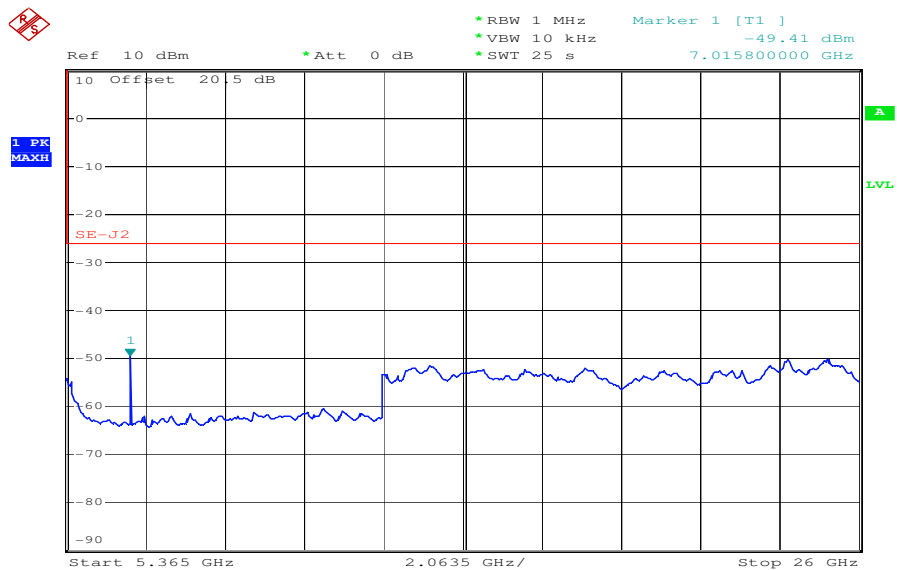

Date: 24.FEB.2011 14:22:40

Plot 9: OFDM, highest channel, 30 MHz – 1000 MHz

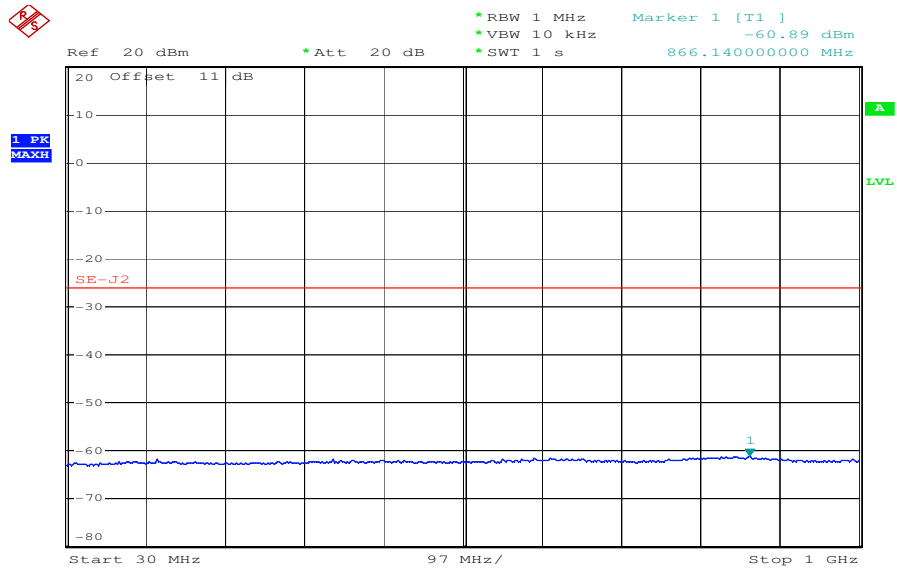

Date: 24.FEB.2011 13:47:25

Plot 10: OFDM, highest channel, 1000 MHz – 5233.3 MHz

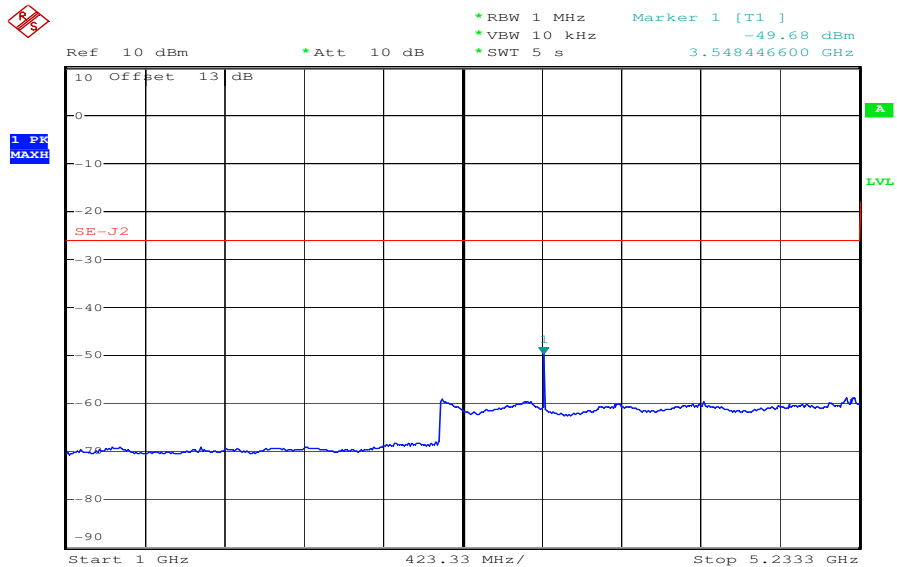

Date: 24.FEB.2011 13:50:13

Plot 11: OFDM, highest channel, 5233.3 MHz – 5365 MHz

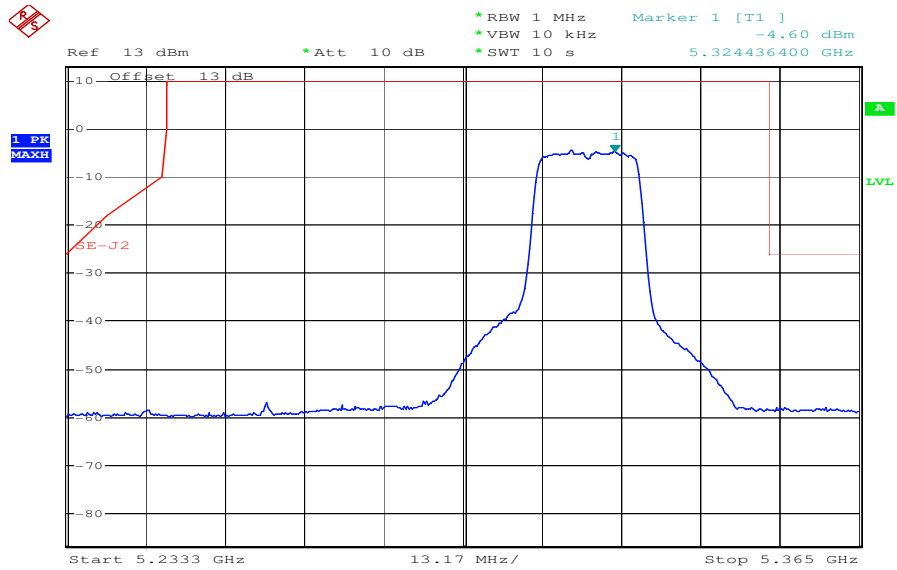

Date: 24.FEB.2011 14:16:37

Plot 12: OFDM, highest channel, 5365 MHz – 26000 MHz

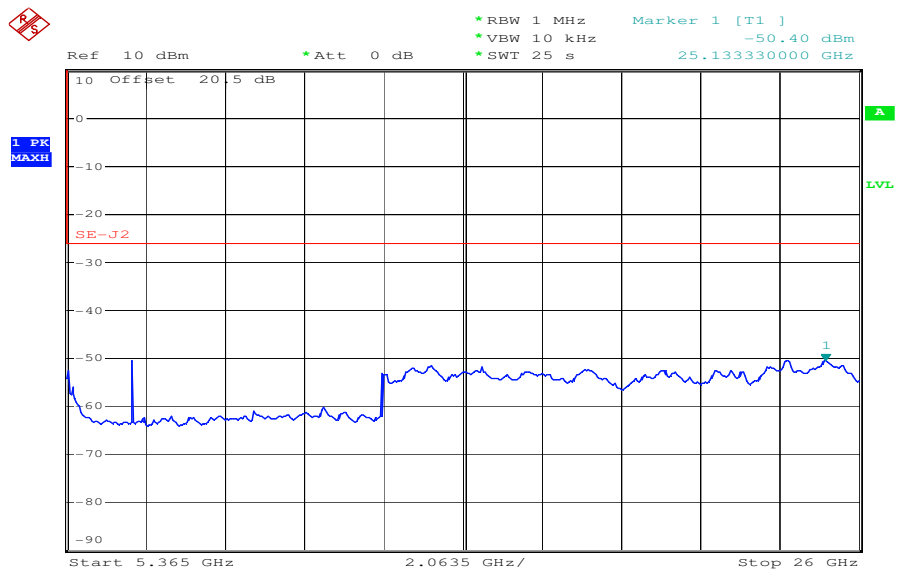

Date: 24.FEB.2011 14:26:25

Plots: OFDM / n – mode, power index 21, MCS 7, band 2

Plot 1: OFDM, lowest channel, 30 MHz – 1000 MHz

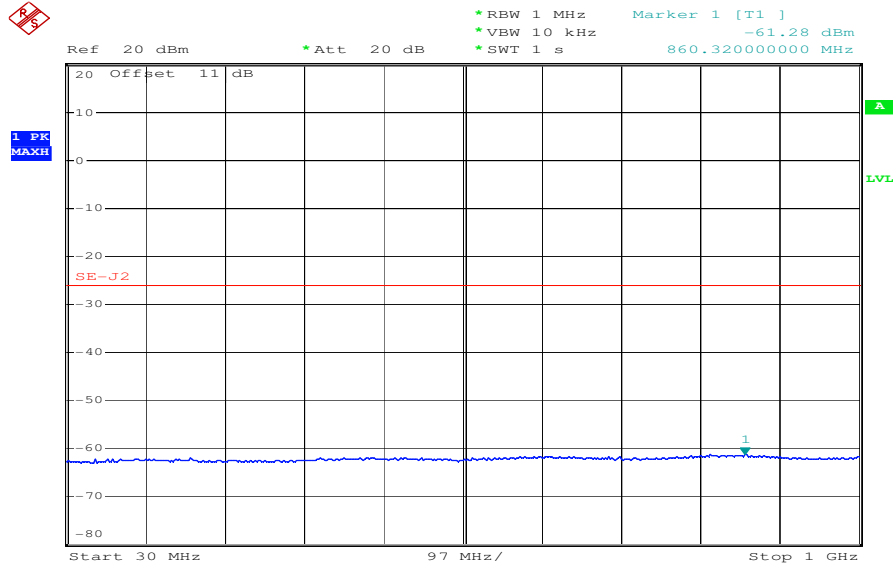

Date: 24.FEB.2011 13:45:30

Plot 2: OFDM, lowest channel, 1000 MHz – 5233.3 MHz

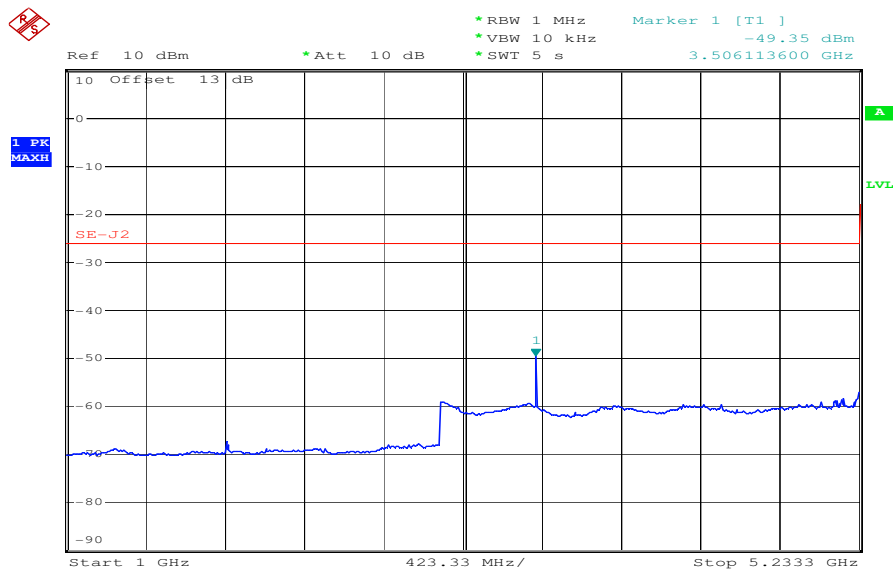

Date: 24.FEB.2011 14:07:38

Plot 3: OFDM, lowest channel, 5233.3 MHz – 5365 MHz

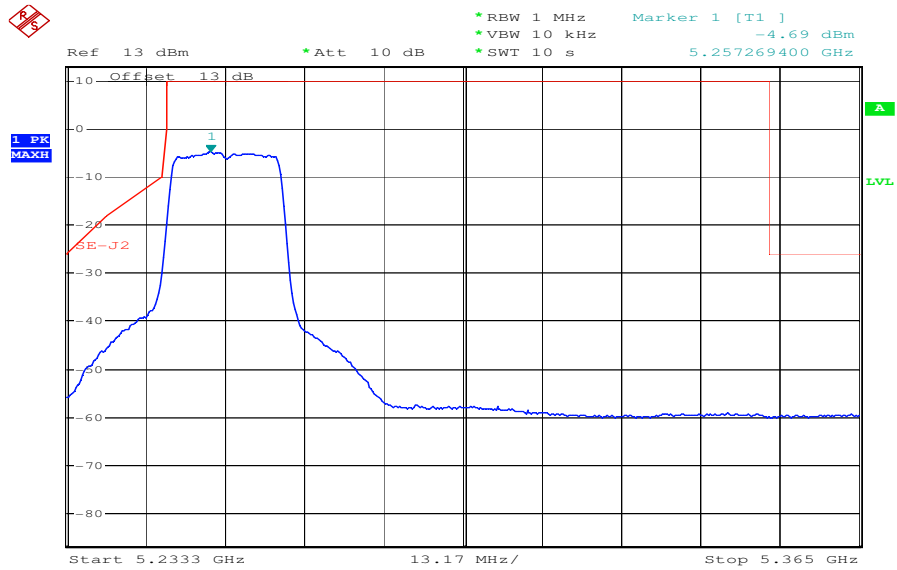

Date: 24.FEB.2011 14:12:21

Plot 4: OFDM, lowest channel, 5365 MHz – 26000 MHz

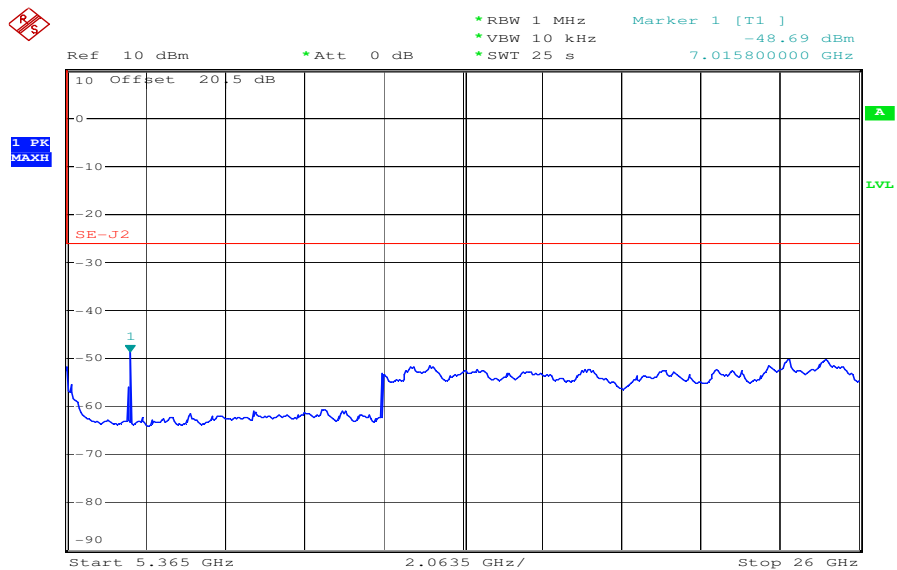

Date: 24.FEB.2011 14:21:13

Plot 5: OFDM, middle channel, 30 MHz – 1000 MHz

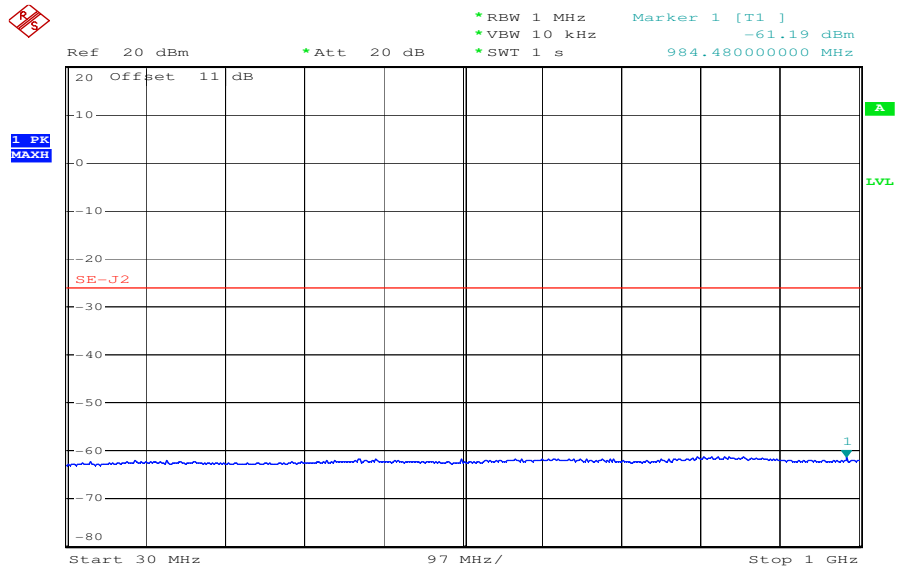

Date: 24.FEB.2011 13:46:47

Plot 6: OFDM, middle channel, 1000 MHz – 5233.3 MHz

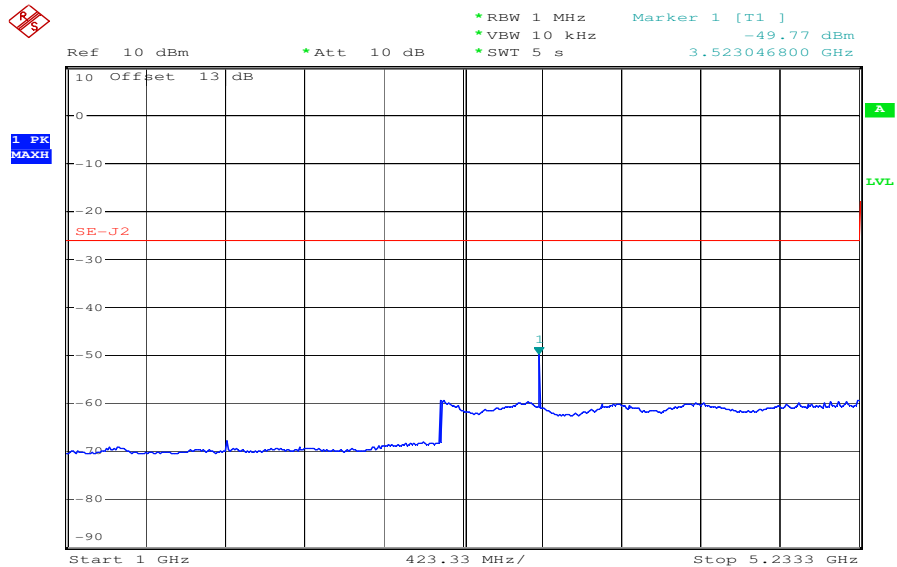

Date: 24.FEB.2011 14:02:22

Plot 7: OFDM, middle channel, 5233.3 MHz – 5365 MHz

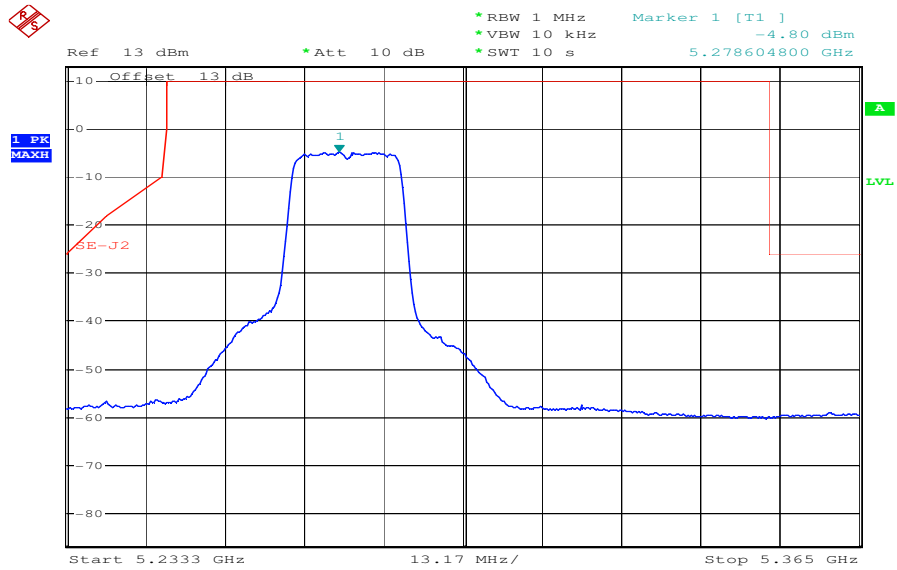

Date: 24.FEB.2011 14:15:50

Plot 8: OFDM, middle channel, 5365 MHz – 26000 MHz

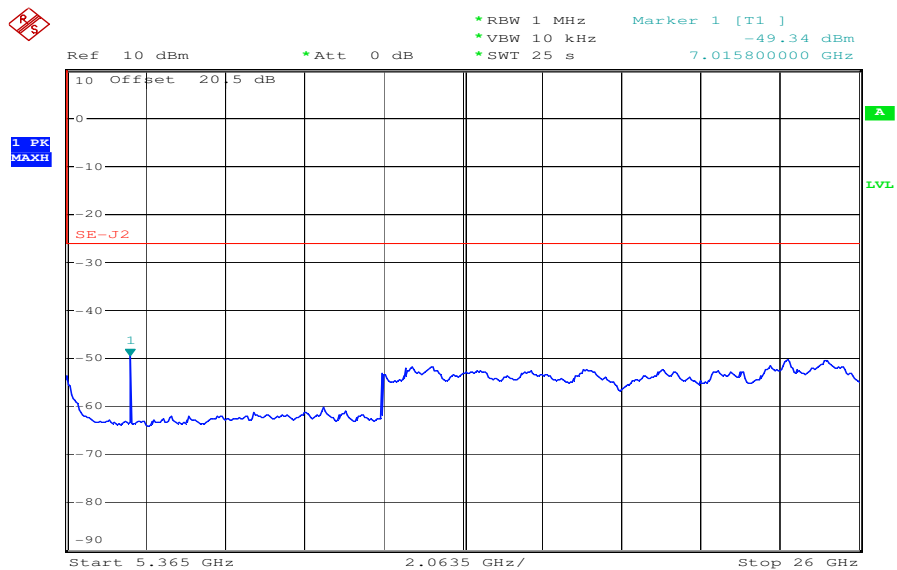

Date: 24.FEB.2011 14:23:55

Plot 9: OFDM, highest channel, 30 MHz – 1000 MHz

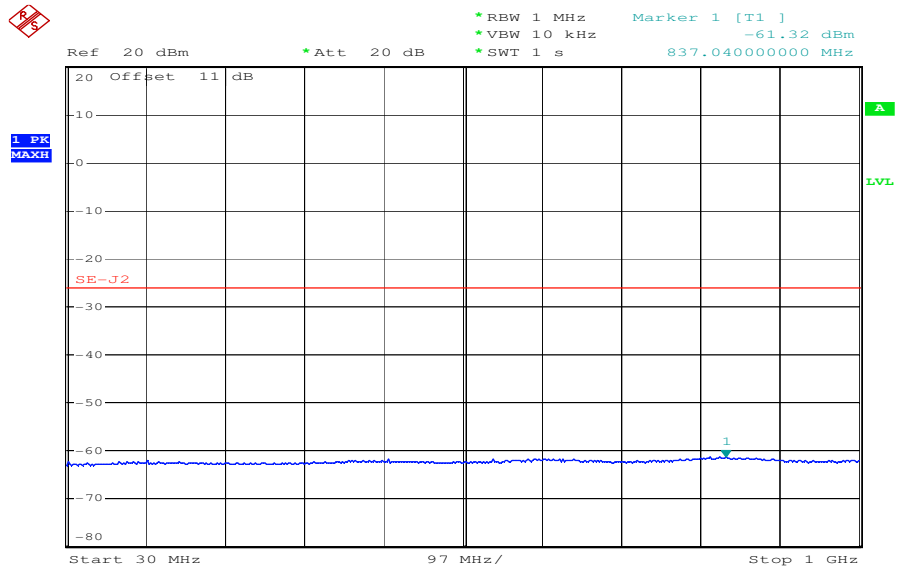

Date: 24.FEB.2011 13:48:01

Plot 10: OFDM, highest channel, 1000 MHz – 5233.3 MHz

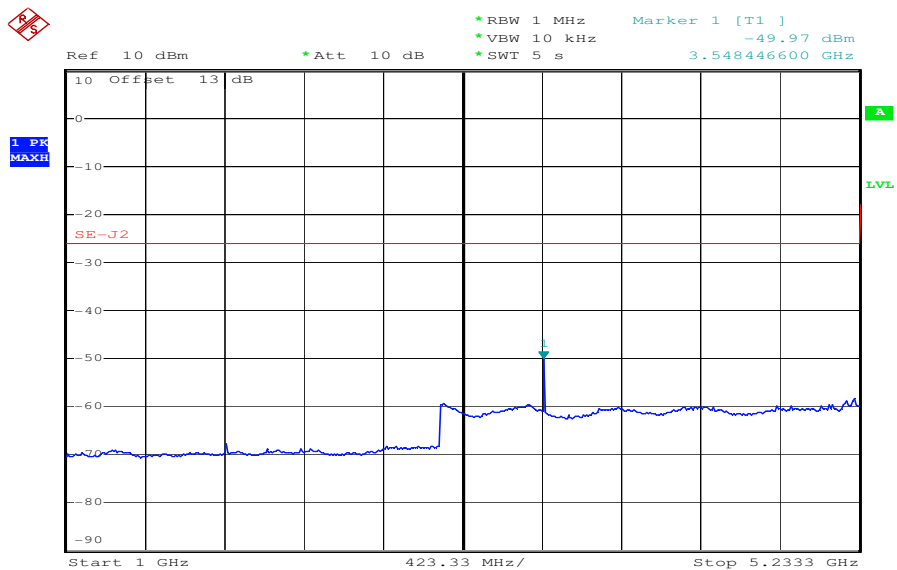

Date: 24.FEB.2011 13:49:38

Plot 11: OFDM, highest channel, 5233.3 MHz – 5365 MHz

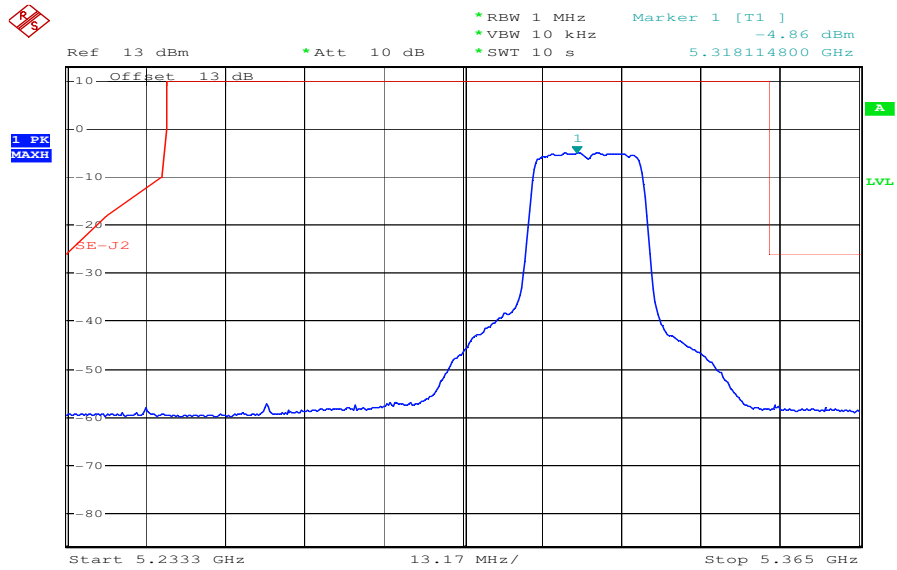

Date: 24.FEB.2011 14:17:19

Plot 12: OFDM, highest channel, 5365 MHz – 26000 MHz

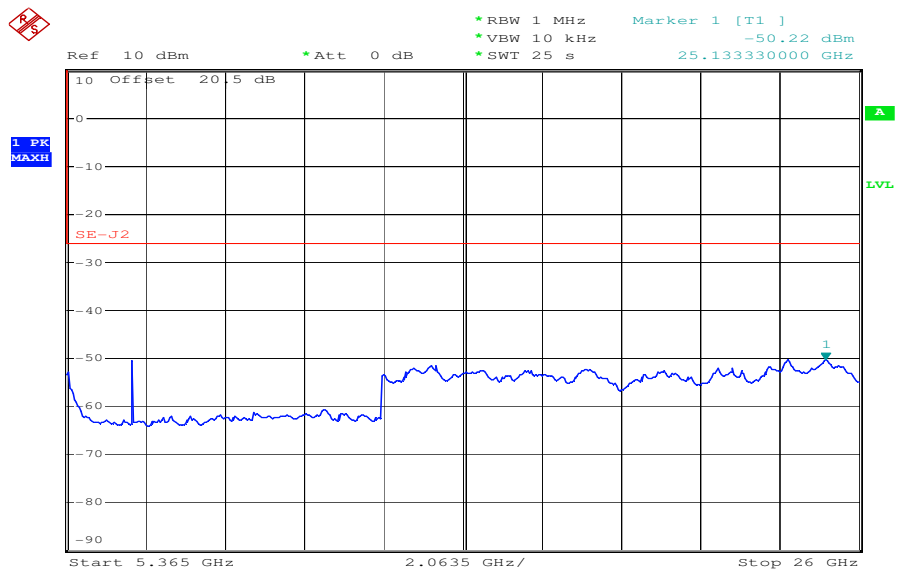

Date: 24.FEB.2011 14:27:38

9.7 Spurious emission intensity - radiated

Measurement parameter:

Measurement parameter	
Detector:	Peak
Sweep time:	Auto
Resolution bandwidth:	f <= 1GHz : 1 MHz f > 1GHz : 1 MHz
Video bandwidth:	f <= 1GHz : 1 MHz f > 1GHz : 1 MHz
Span:	100 MHz steps
Trace-Mode:	Max Hold
Additional EUT parameters:	Test mode (modulated carrier) Modulation with highest output power used Power index 21

Results: band 1 & band 2

OFDM / a – mode	lowest channel f _{TX} = 5180 MHz		mid channel f _{TX} = 5200 MHz		highest channel f _{TX} = 5240 MHz	
	F [MHz]	Level [dBm]	F [MHz]	Level [dBm]	F [MHz]	Level [dBm]
Found peaks:	4160	-46.17 (vertical) -48.83 (horizontal)	10400	-31.84 (vertical) -33.25 (horizontal)	10480	-31.19 (vertical) -32.29 (horizontal)
	10360	-32.87 (vertical) -34.39 (horizontal)				
	For emissions above 12.75 GHz, please take a look at the plots!					

OFDM / a – mode	lowest channel f _{TX} = 5260 MHz		mid channel f _{TX} = 5280 MHz		highest channel f _{TX} = 5320 MHz	
	F [MHz]	Level [dBm]	F [MHz]	Level [dBm]	F [MHz]	Level [dBm]
Found peaks:	10520	-32.42 (vertical) -32.92 (horizontal)	10560	-31.24 (vertical) -31.87 (horizontal)	10640	-32.57 (vertical) -34.84 (horizontal)
	For emissions above 12.75 GHz, please take a look at the plots!					

OFDM / n – mode	lowest channel f _{TX} = 5180 MHz		mid channel f _{TX} = 5200 MHz		highest channel f _{TX} = 5240 MHz	
	F [MHz]	Level [dBm]	F [MHz]	Level [dBm]	F [MHz]	Level [dBm]
Found peaks:	10360	-32.23 (vertical) -33.74 (horizontal)	3466.8	-46.81 (vertical) -49.05 (horizontal)	10480	-31.94 (vertical) -33.14 (horizontal)
			4160	-46.58 (vertical) -49.90 (horizontal)		
			10400	-31.05 (vertical) -32.51 (horizontal)		
	For emissions above 12.75 GHz, please take a look at the plots!					

OFDM / n – mode	lowest channel f _{TX} = 5260 MHz		mid channel f _{TX} = 5280 MHz		highest channel f _{TX} = 5320 MHz	
	F [MHz]	Level [dBm]	F [MHz]	Level [dBm]	F [MHz]	Level [dBm]
Found peaks:	10520	-31.98 (vertical) -32.77 (horizontal)	10560	-31.17 (vertical) -34.02 (horizontal)	10640	-32.91 (vertical) -35.22 (horizontal)
	For emissions above 12.75 GHz, please take a look at the plots!					

Limit:

Limit
30 MHz <= f <= 5135 MHz: 2.5uW (-26.02 dBm) 5135 MHz <= f <= 5142 MHz: 2.5uW (-26.02 dBm) 5142 MHz <= f <= 5150 MHz: 15uW (-18.24 dBm) 5250 MHz : 1mW (0 dBm) 5251 MHz : 0.1mW (-10 dBm) 5260 MHz : 15.8mW (-18.01 dBm) 5266.7 MHz : 15.8mW (-26.02 dBm) 5266.7 MHz <= f <= 5365 MHz: 2.5uW (-26.02dBm) 5365 MHz <= f <= 12000 MHz: 2.5uW (-26.02dBm)

Result: The result of the measurement is passed.

Plots: OFDM / a – mode, band 1 and band 2

Band 1:

Plot 1: Lowest channel – 5180 MHz; (30MHz – 1 GHz) – vertical

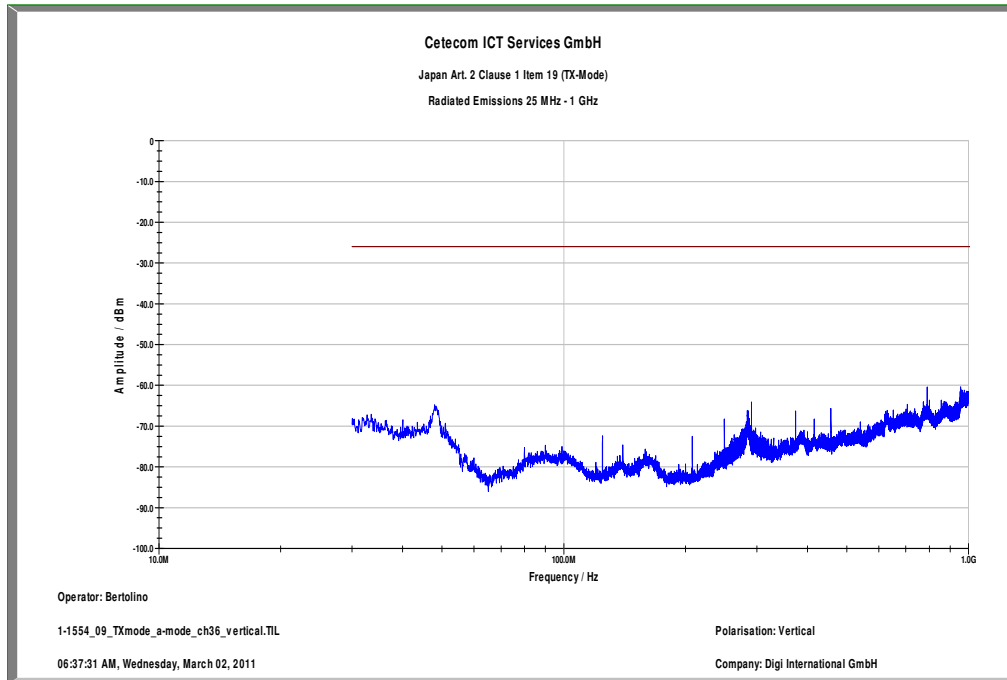

Plot 2: Lowest channel – 5180 MHz; (1 GHz – 12.75 GHz) – vertical

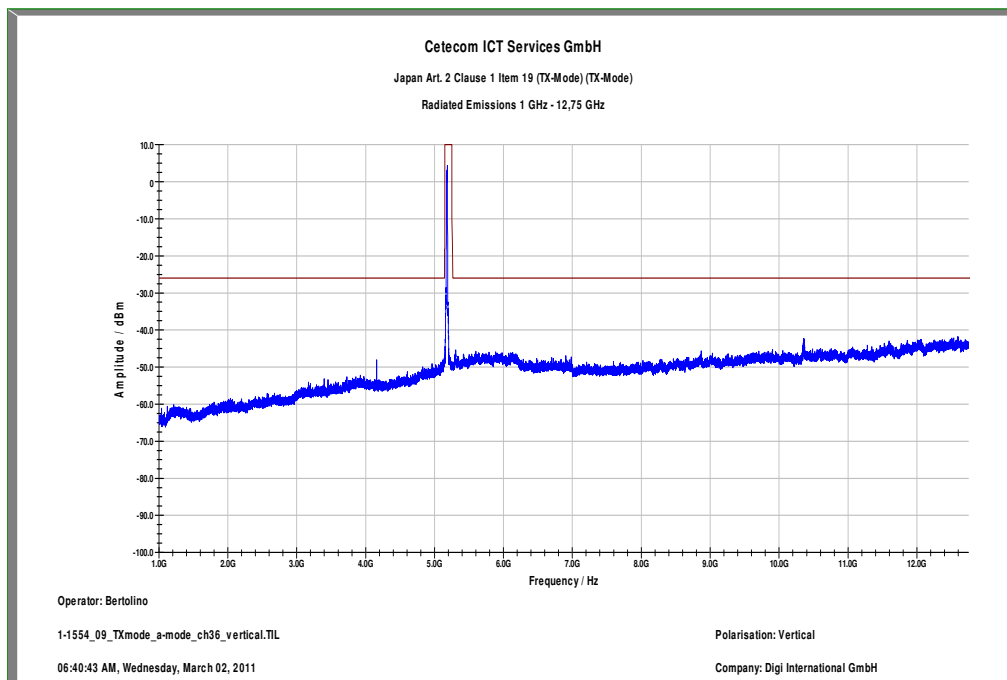

Plot 3: Lowest channel – 5180 MHz; (30MHz – 1 GHz) – horizontal

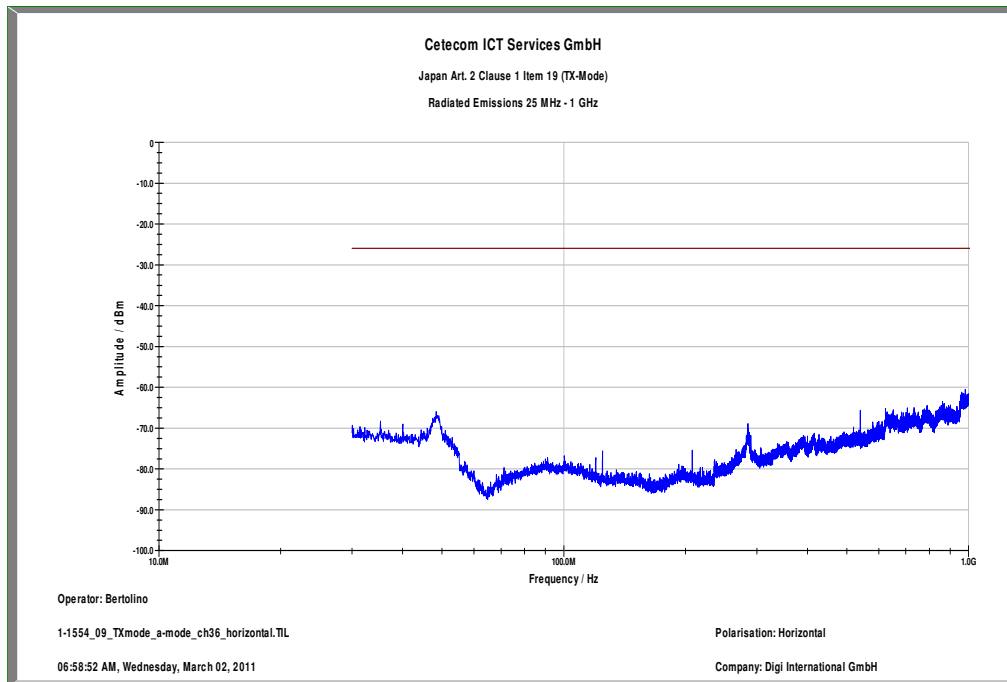

Plot 4: Lowest channel – 5180 MHz; (1 GHz – 12.75 GHz) – horizontal

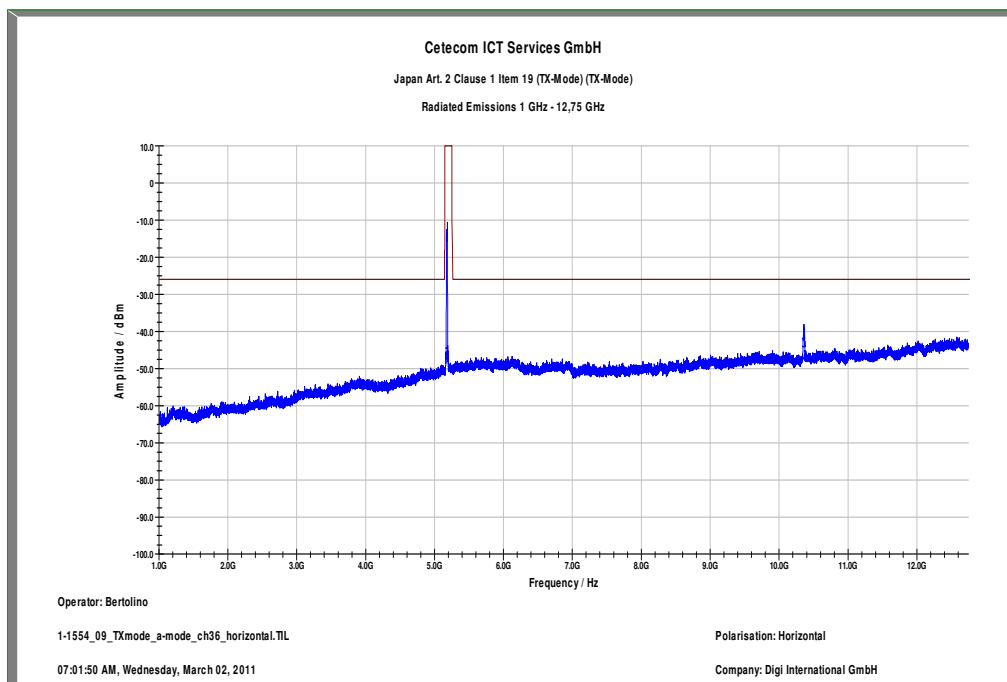

Plot 5: Lowest channel – 5180 MHz; (12.75 GHz – 18 GHz) – vertical & horizontal

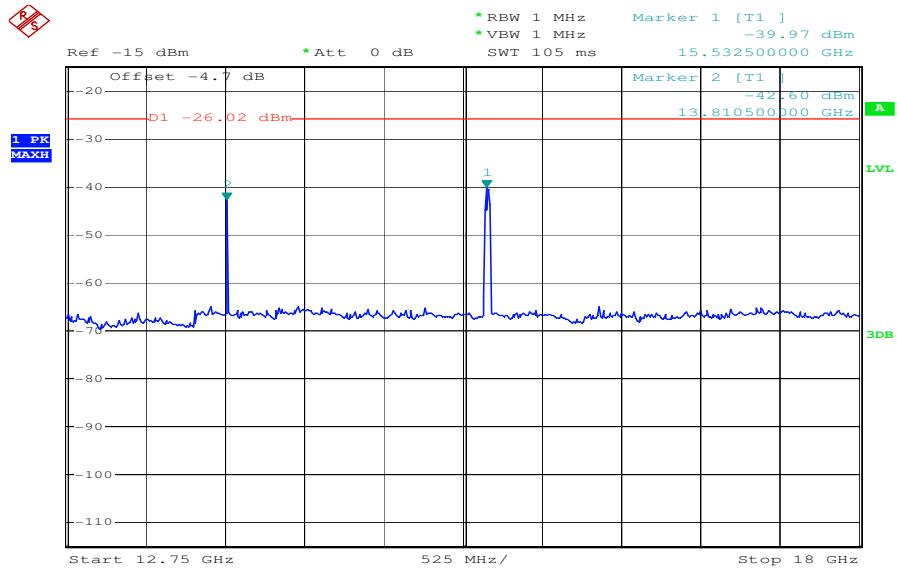

Date: 2.MAR.2011 13:39:03

Plot 6: Lowest channel – 5180 MHz; (18 GHz – 26 GHz) – vertical & horizontal

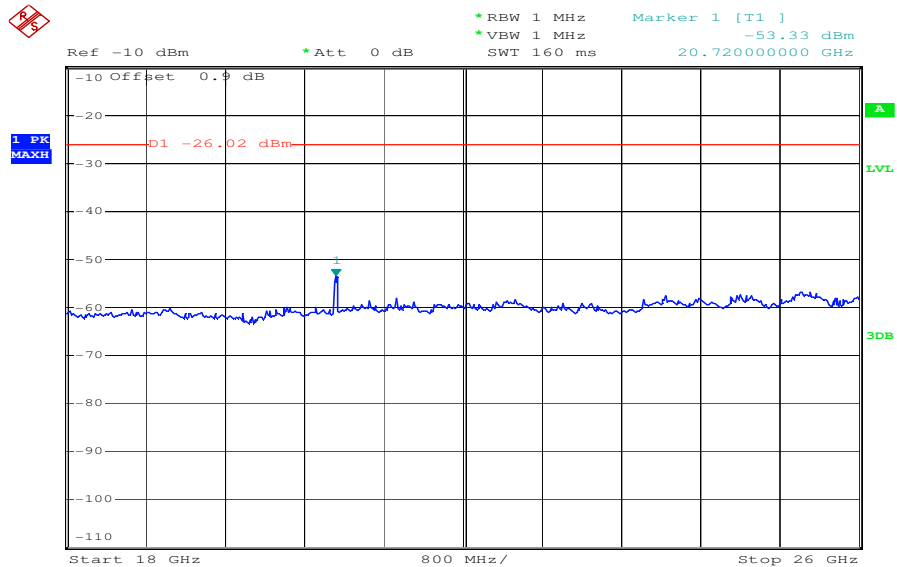

Date: 2.MAR.2011 14:16:26

Plot 7: Middle channel – 5200 MHz; (30MHz – 1 GHz) – vertical

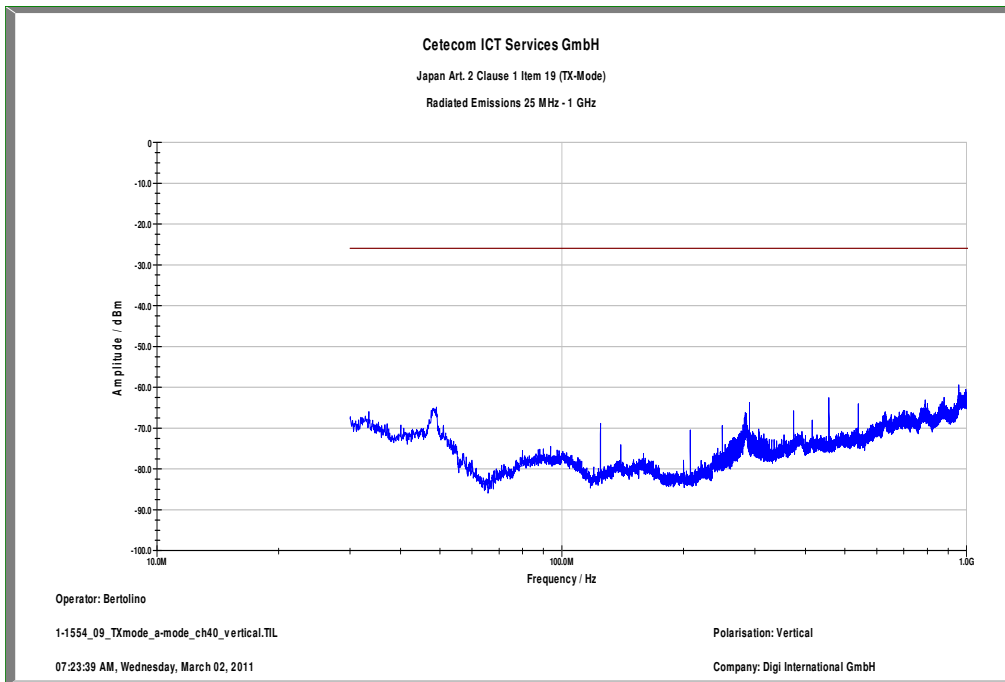

Plot 8: Middle channel – 5200 MHz; (1 GHz – 12.75 GHz) – vertical

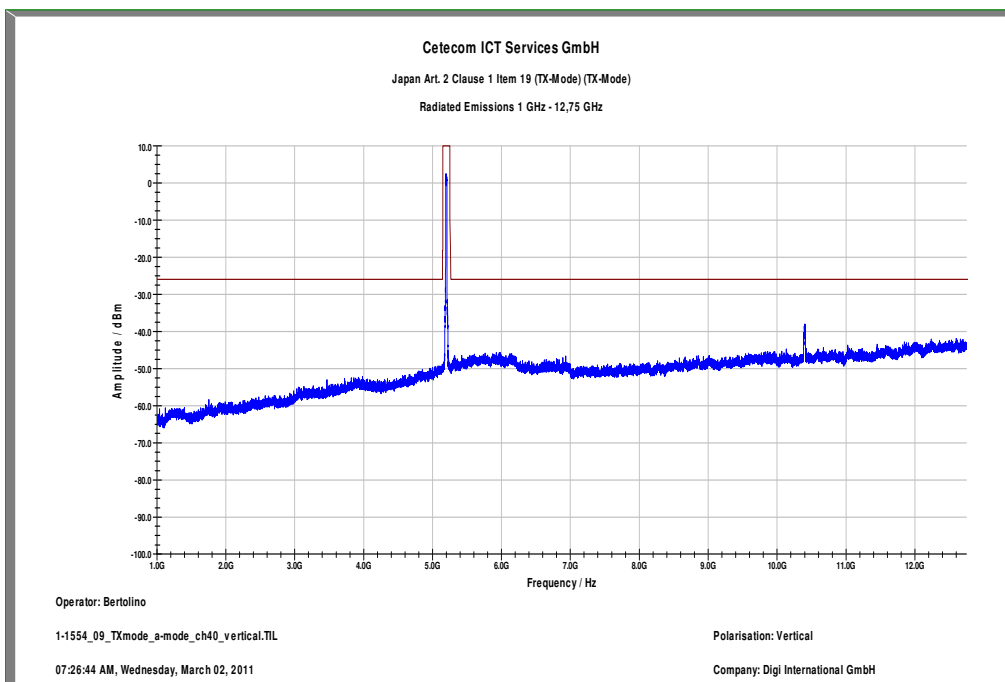

Plot 9: Middle channel – 5200 MHz; (30MHz – 1 GHz) – horizontal

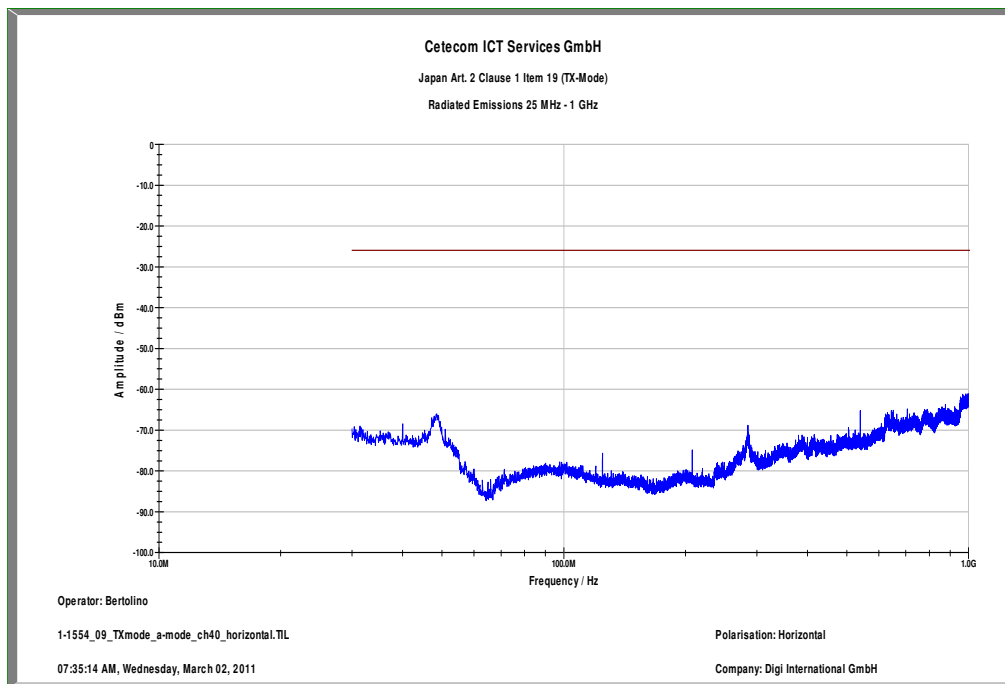

Plot 10: Middle channel – 5200 MHz; (1 GHz – 12.75 GHz) – horizontal

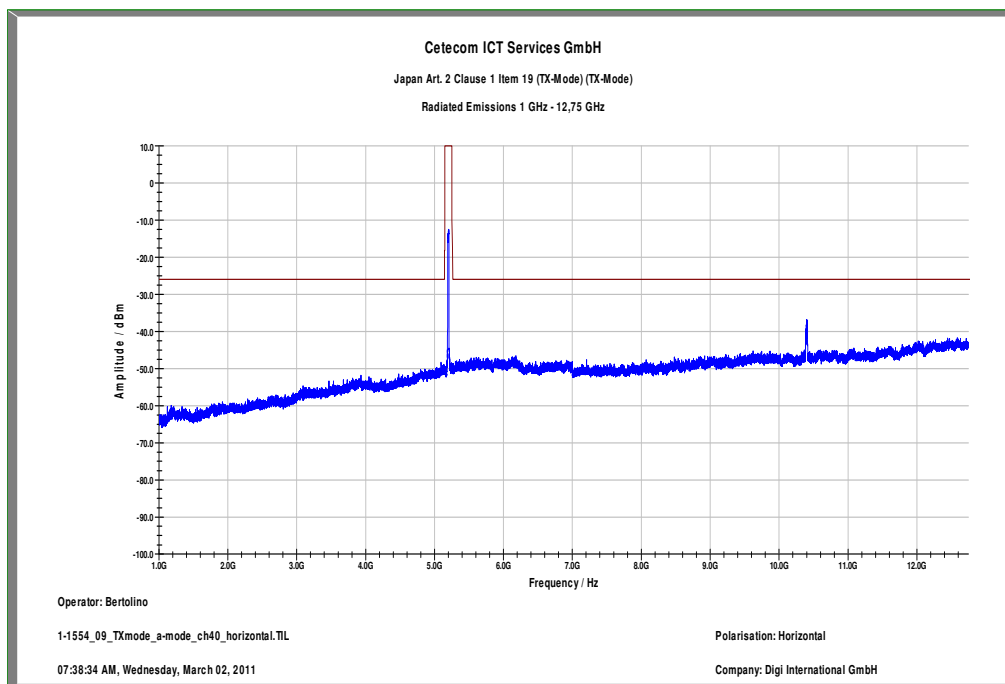

Plot 11: Middle channel – 5200 MHz; (12.75 GHz – 18 GHz) – vertical & horizontal

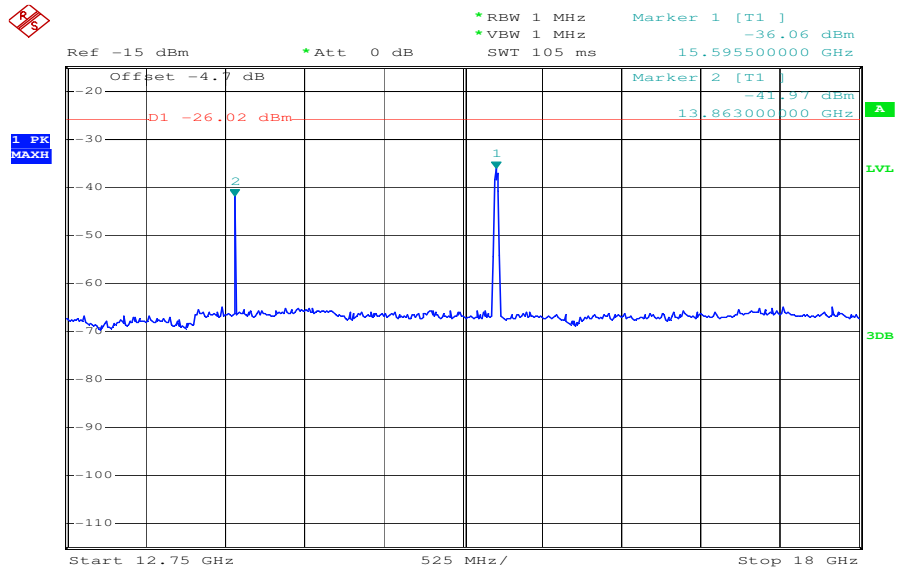

Date: 2.MAR.2011 13:42:41

Plot 12: Middle channel – 5200 MHz; (18 GHz – 26 GHz) – vertical & horizontal

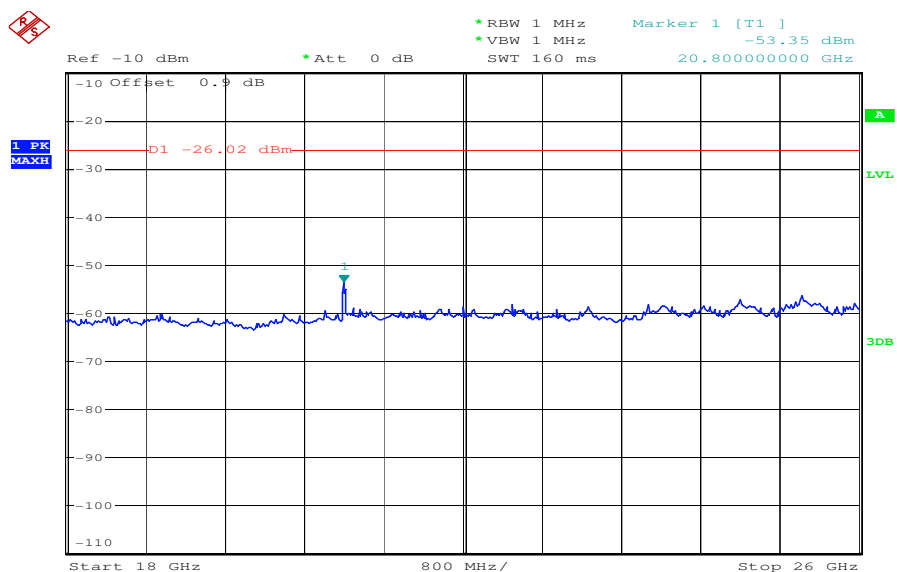

Date: 2.MAR.2011 14:18:18

Plot 13: Highest channel – 5240 MHz; (30MHz – 1 GHz) – vertical

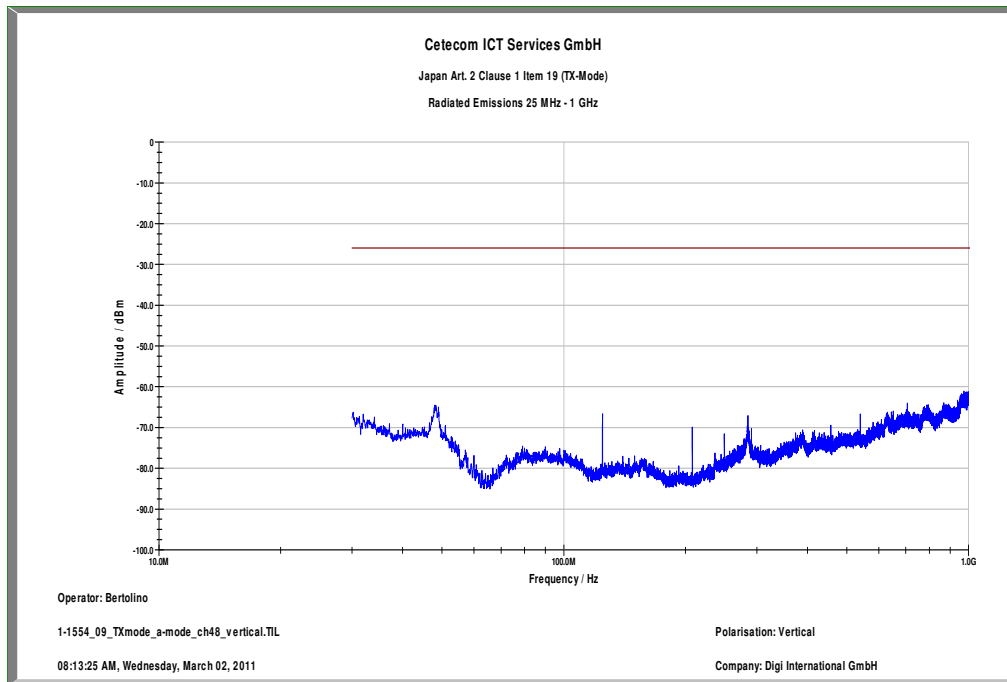

Plot 14: Highest channel – 5240 MHz; (1 GHz – 12.75 GHz) – vertical

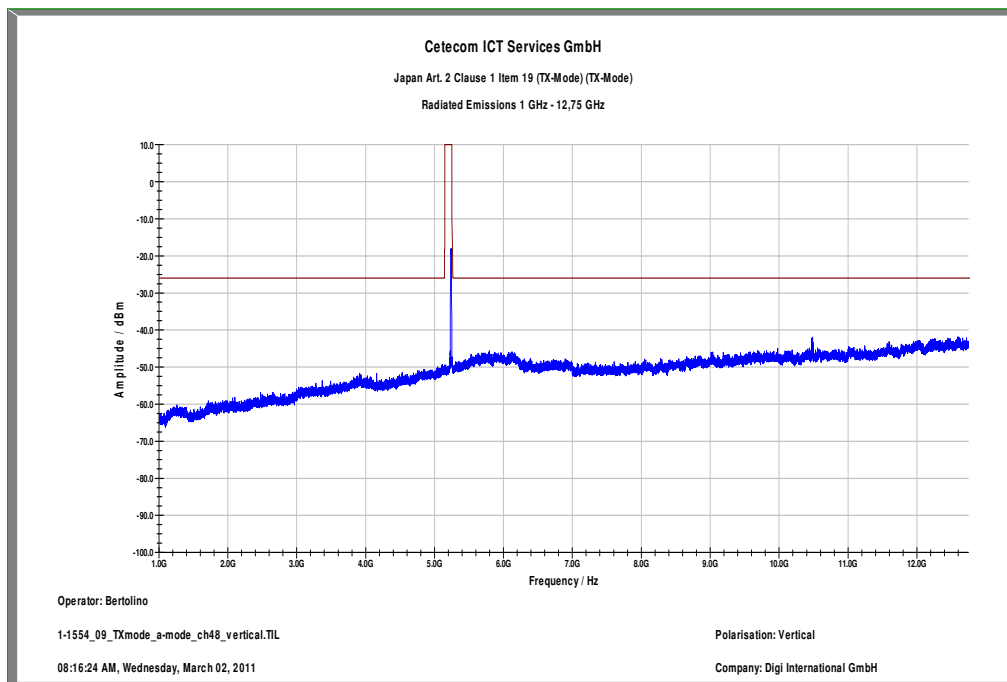

Plot 15: Highest channel – 5240 MHz; (30MHz – 1 GHz) – horizontal

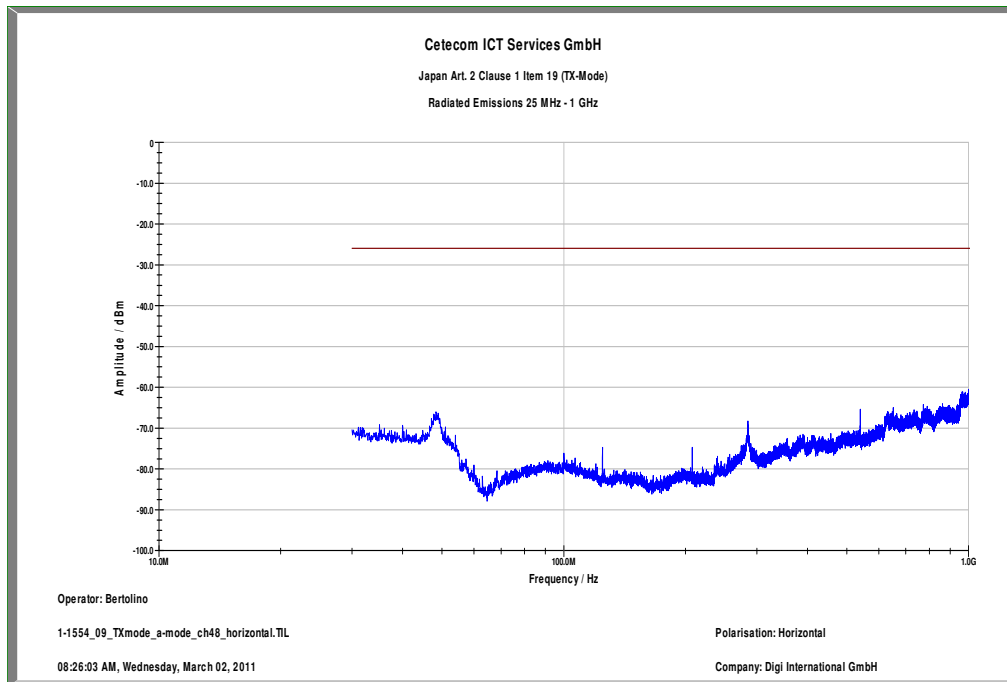

Plot 16: Highest channel – 5240 MHz; (1 GHz – 12.75 GHz) – horizontal

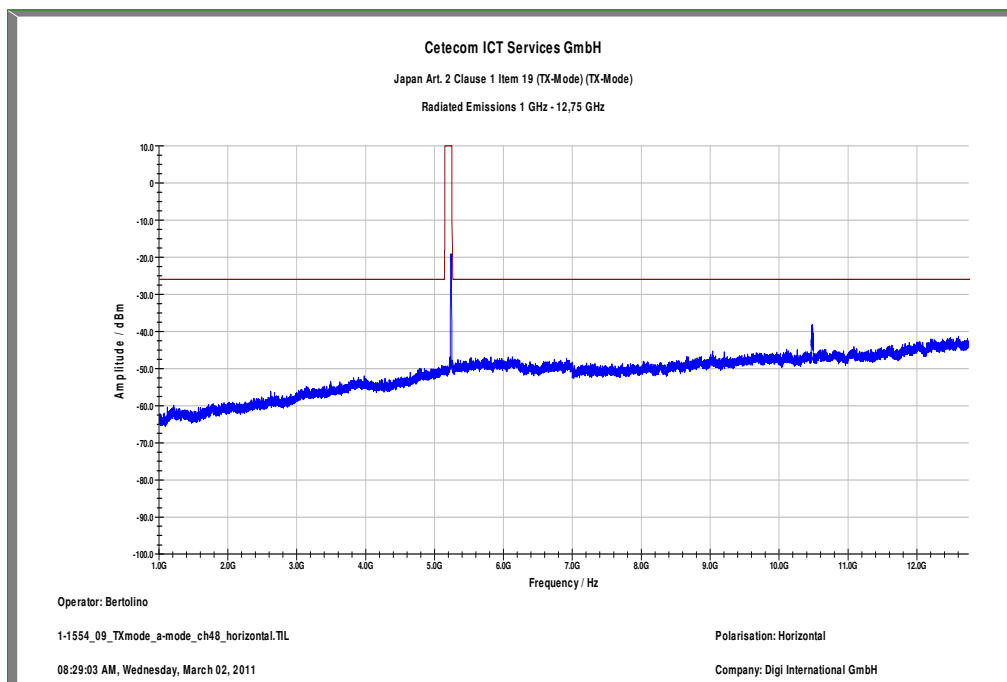

Plot 17: Highest channel – 5240 MHz; (12.75 GHz – 18 GHz) – vertical & horizontal

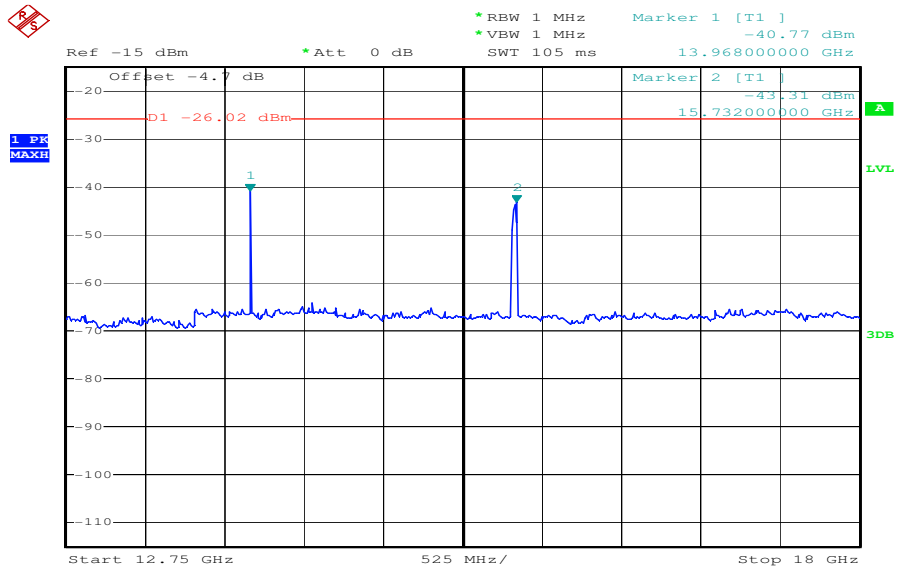

Date: 2.MAR.2011 13:46:14

Plot 18: Highest channel – 5240 MHz; (18 GHz – 26 GHz) – vertical & horizontal

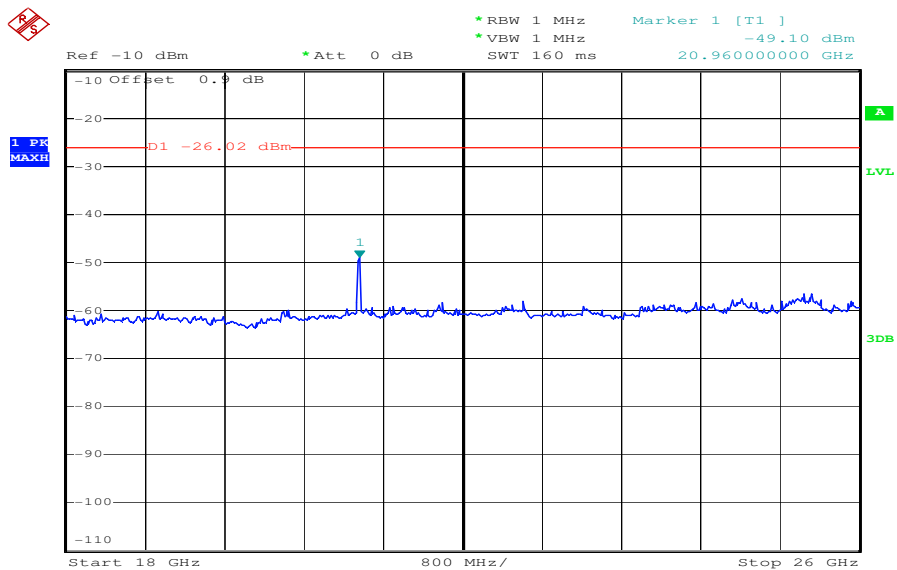

Date: 2.MAR.2011 14:21:40

Band 2:

Plot 1: Lowest channel – 5260 MHz; (30MHz – 1 GHz) – vertical

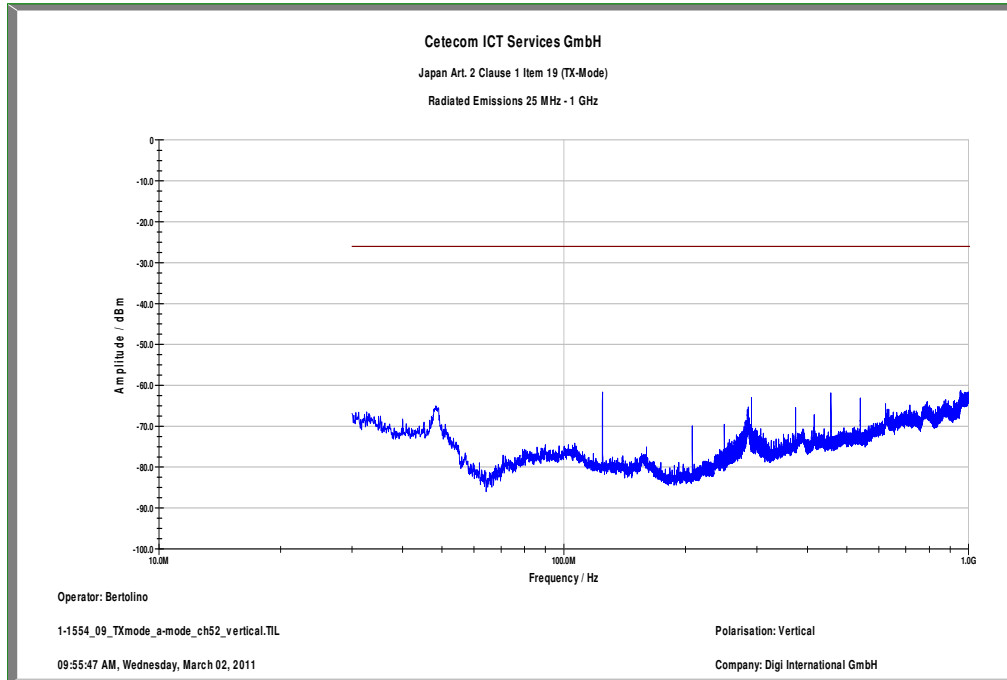

Plot 2: Lowest channel – 5260 MHz; (1 GHz – 12.75 GHz) – vertical

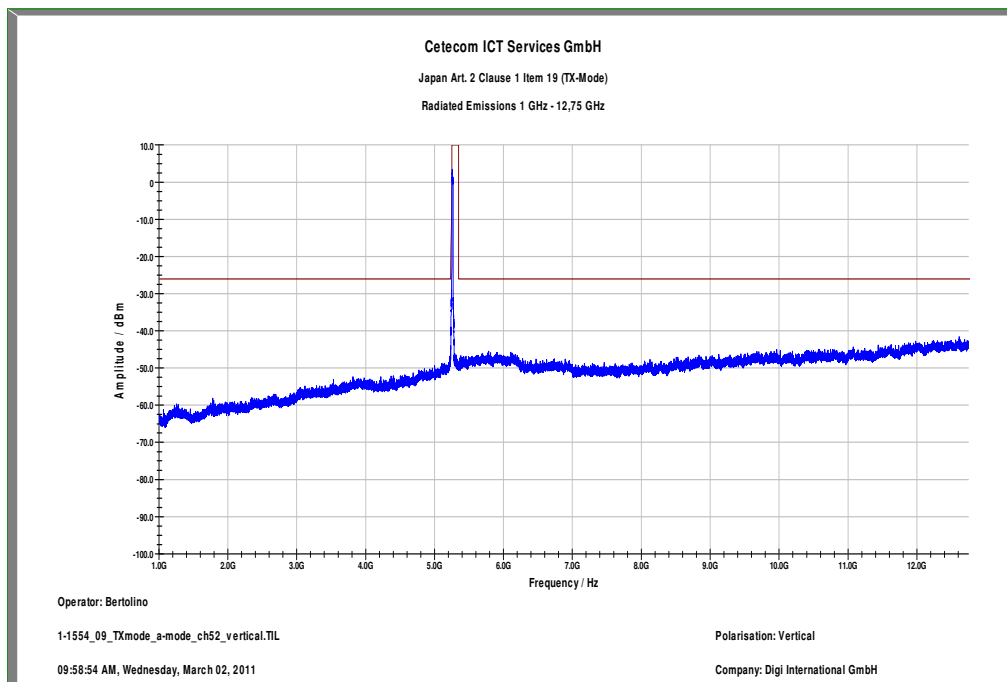

Plot 3: Lowest channel – 5260 MHz; (30MHz – 1 GHz) – horizontal

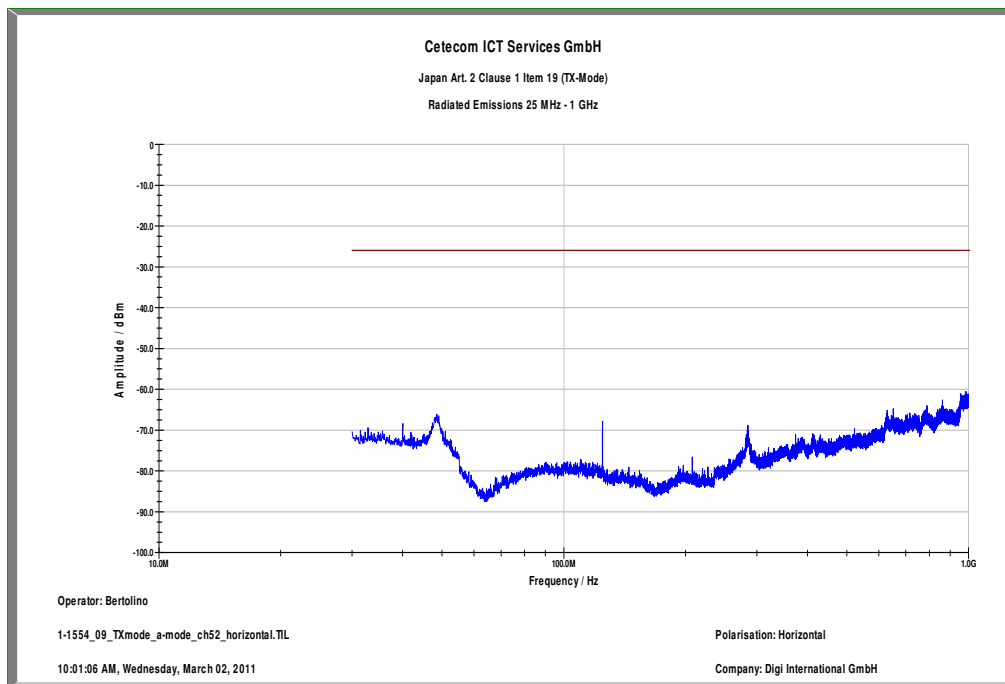

Plot 4: Lowest channel – 5260 MHz; (1 GHz – 12.75 GHz) – horizontal

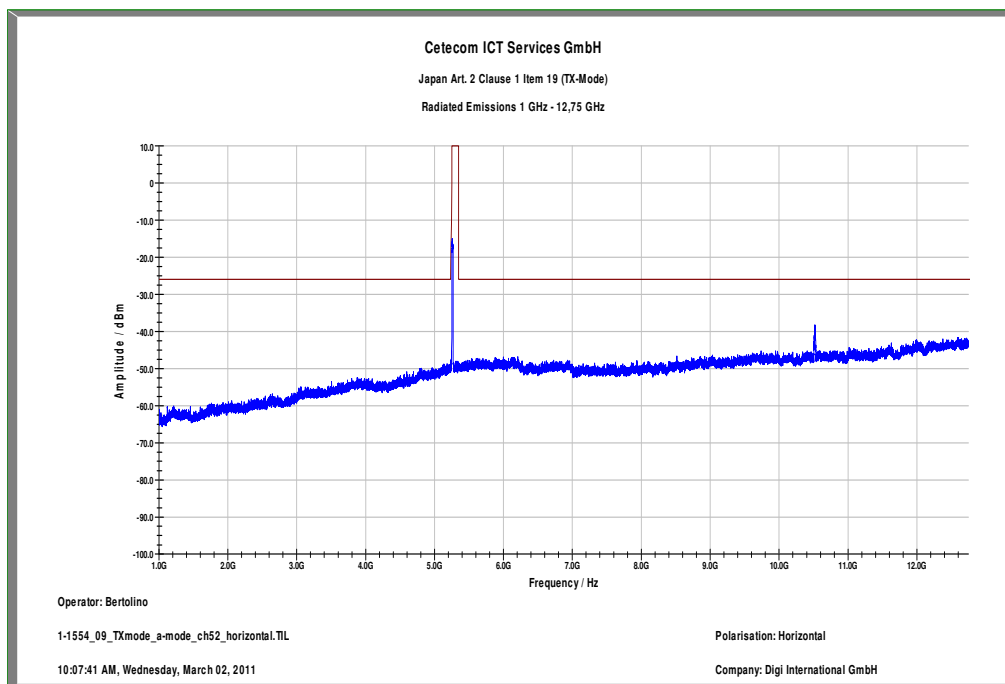

Plot 5: Lowest channel – 5260 MHz; (12.75 GHz – 18 GHz) – vertical & horizontal

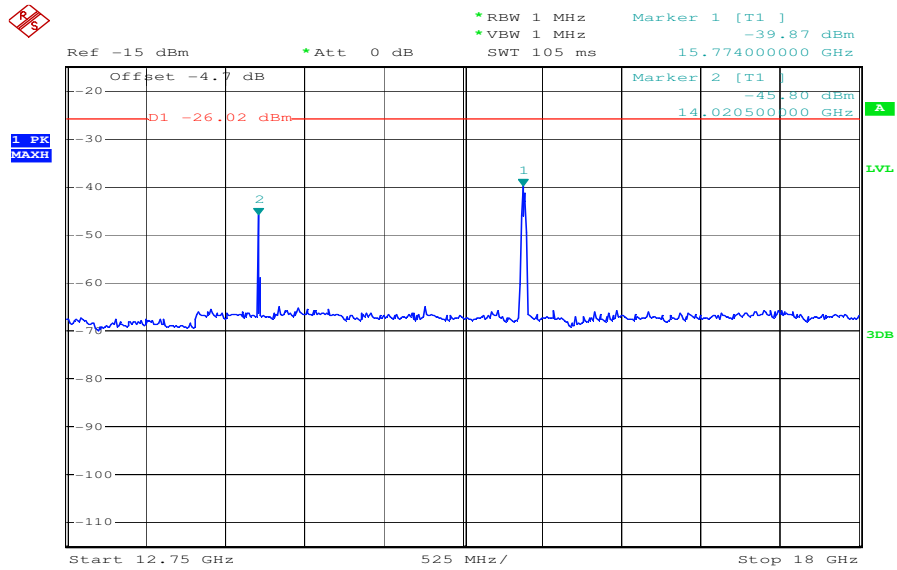

Date: 2.MAR.2011 13:48:32

Plot 6: Lowest channel – 5260 MHz; (18 GHz – 26 GHz) – vertical & horizontal

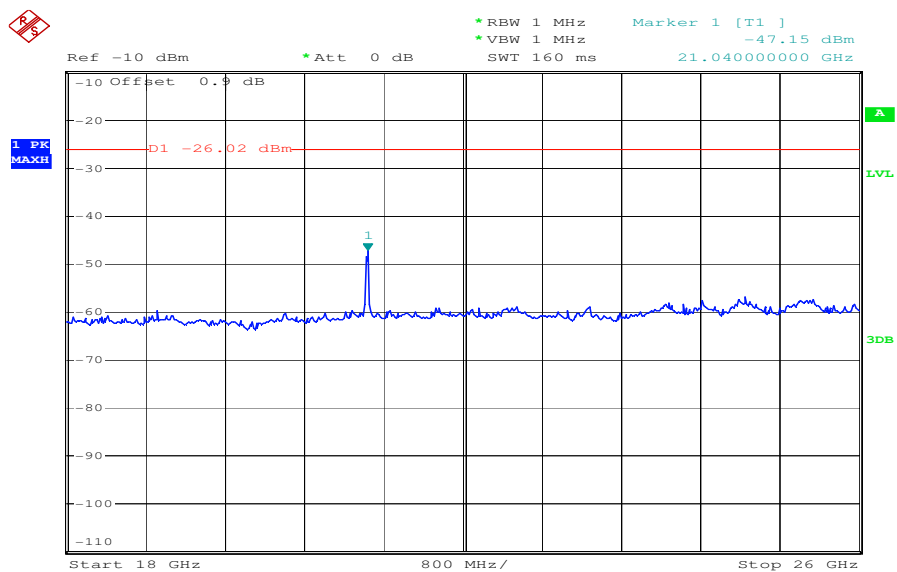

Date: 2.MAR.2011 14:23:22

Plot 7: Middle channel – 5280 MHz; (30MHz – 1 GHz) – vertical

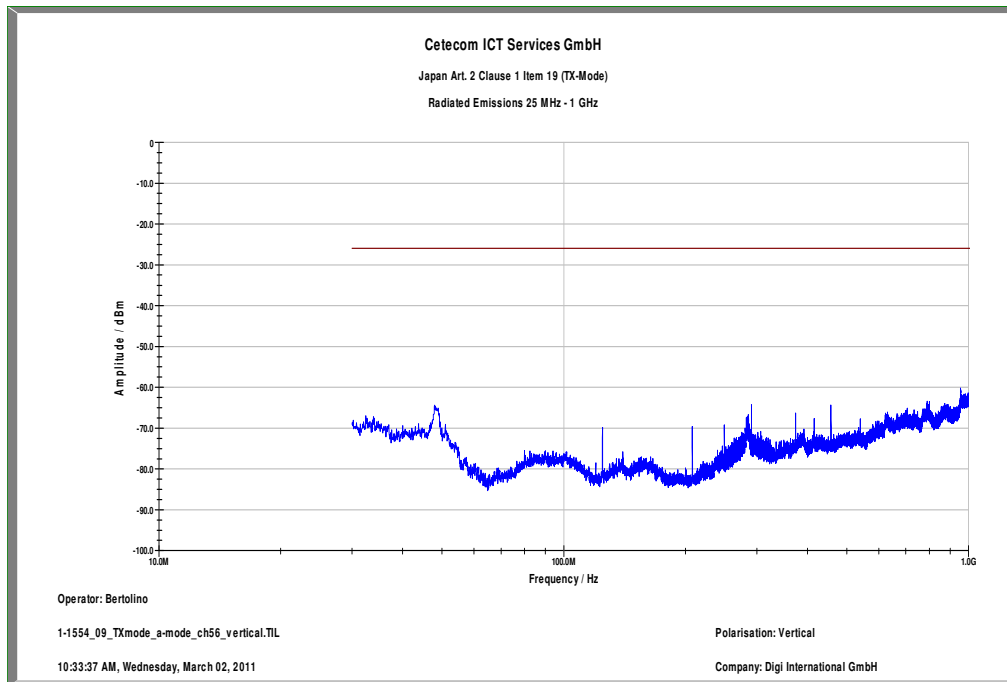

Plot 8: Middle channel – 5280 MHz; (1 GHz – 12.75 GHz) – vertical

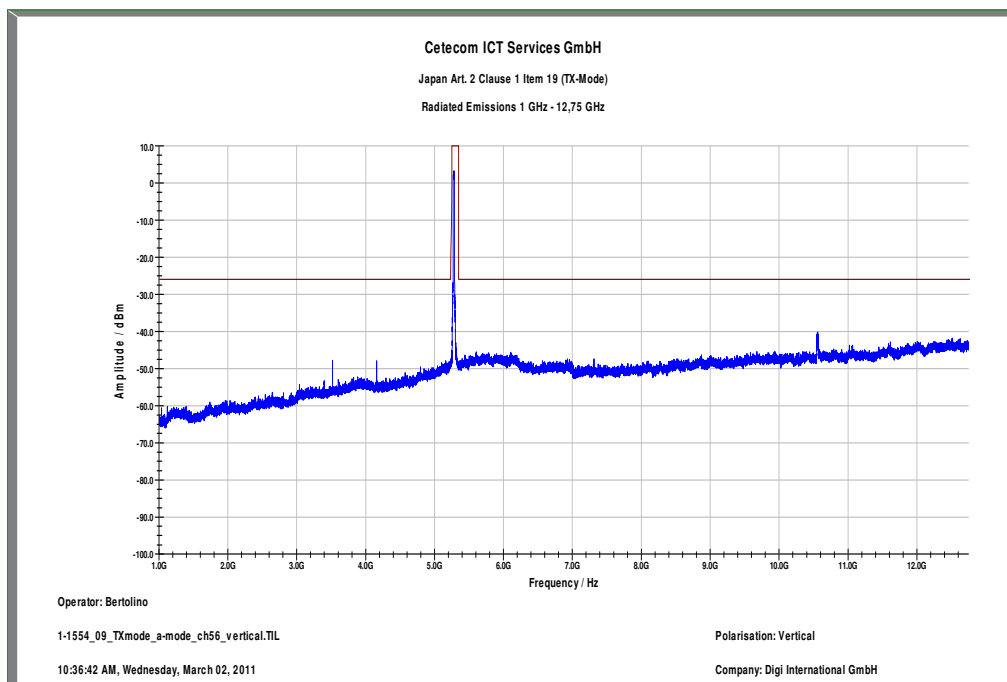

Plot 9: Middle channel – 5280 MHz; (30MHz – 1 GHz) – horizontal

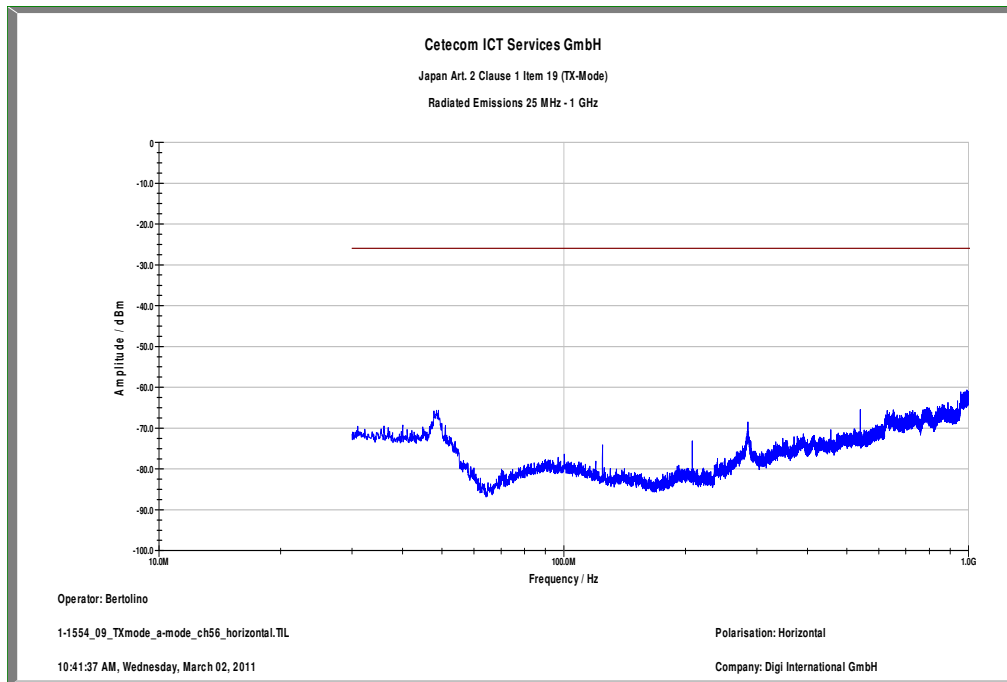

Plot 10: Middle channel – 5280 MHz; (1 GHz – 12.75 GHz) – horizontal

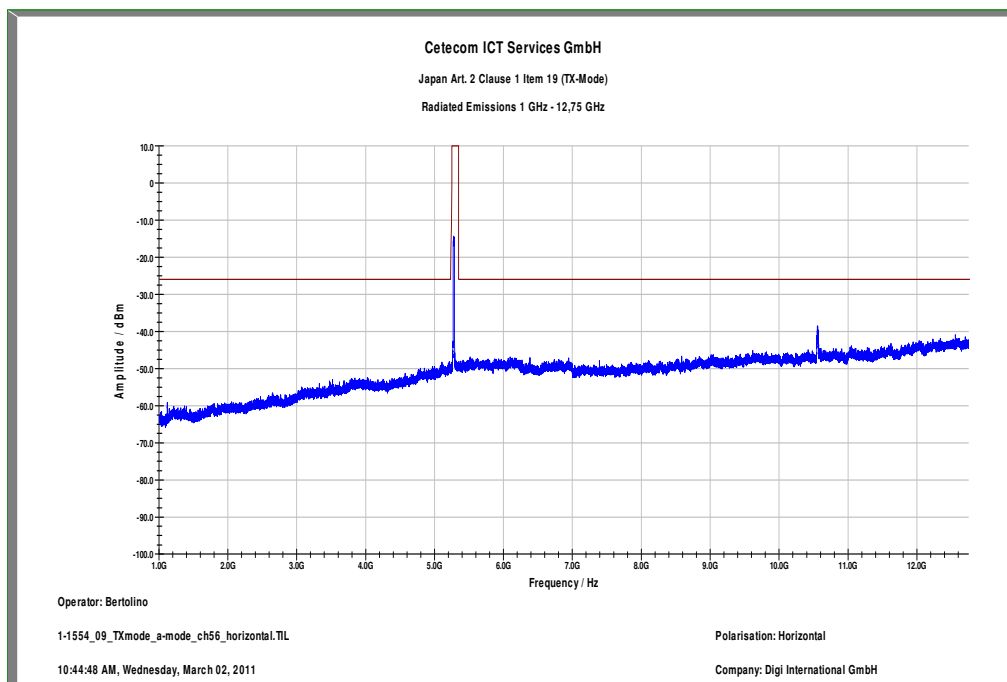

Plot 11: Middle channel – 5280 MHz; (12.75 GHz – 18 GHz) – vertical & horizontal

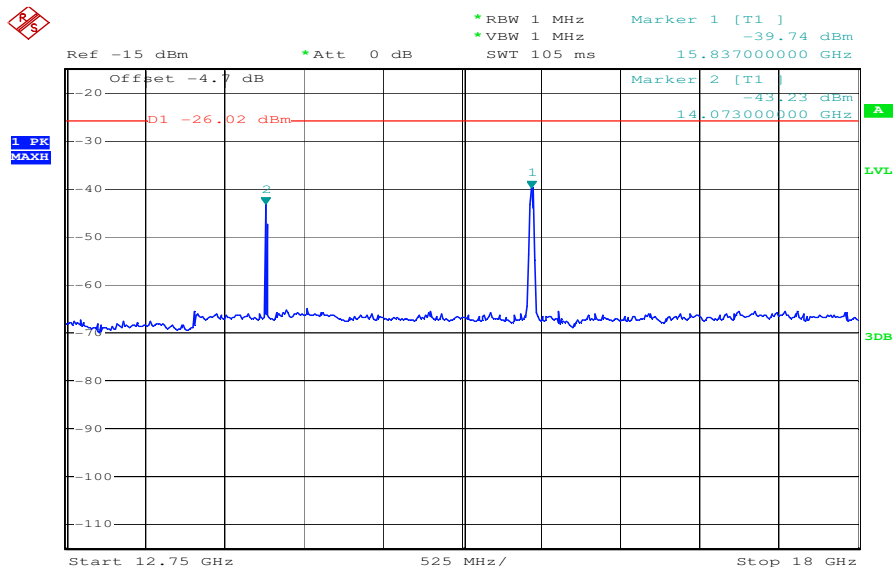

Date: 2.MAR.2011 13:51:49

Plot 12: Middle channel – 5280 MHz; (18 GHz – 26 GHz) – vertical & horizontal

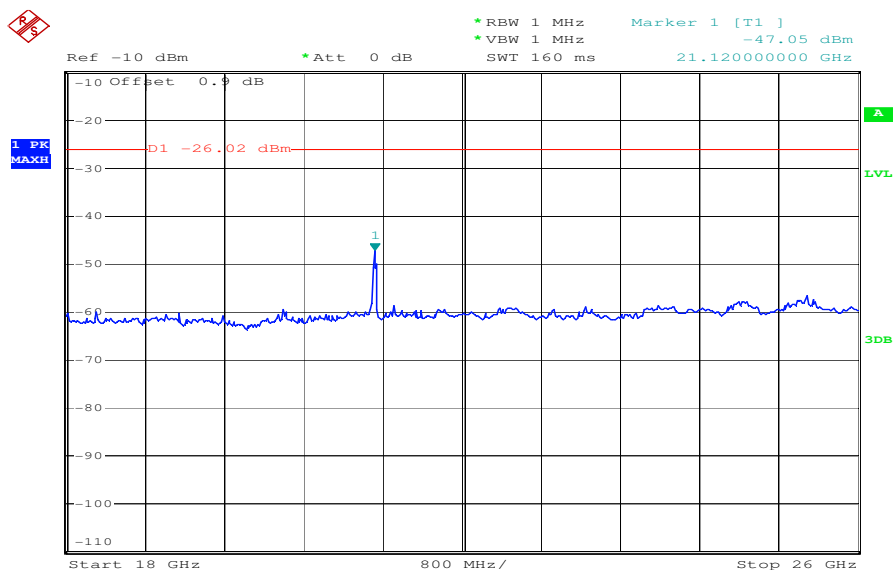

Date: 2.MAR.2011 14:25:02

Plot 13: Highest channel – 5320 MHz; (30MHz – 1 GHz) – vertical

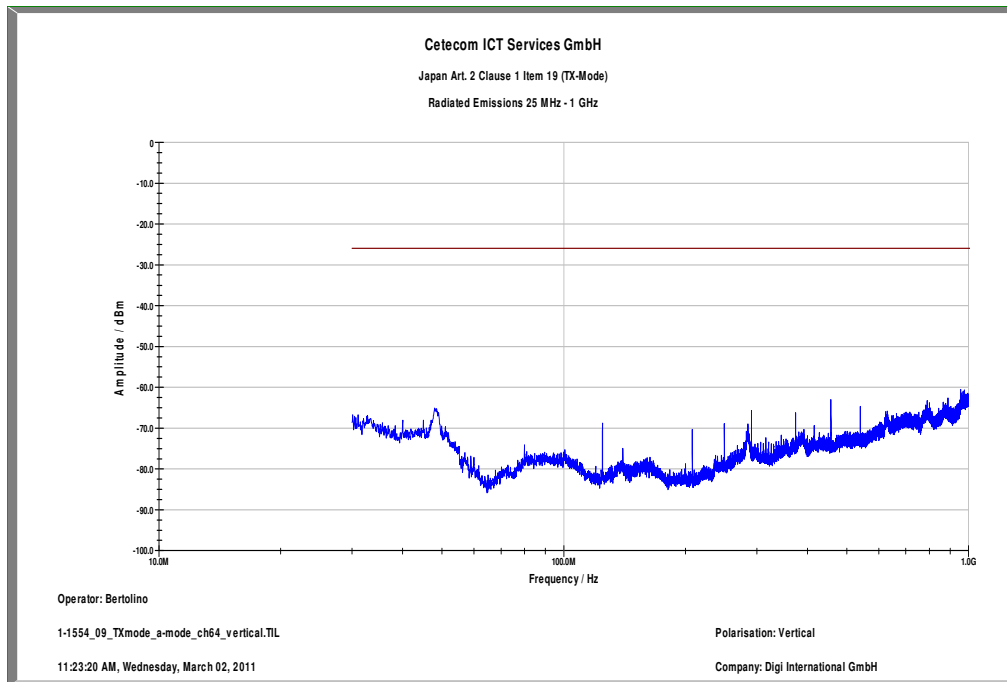

Plot 14: Highest channel – 5320 MHz; (1 GHz – 12.75 GHz) – vertical

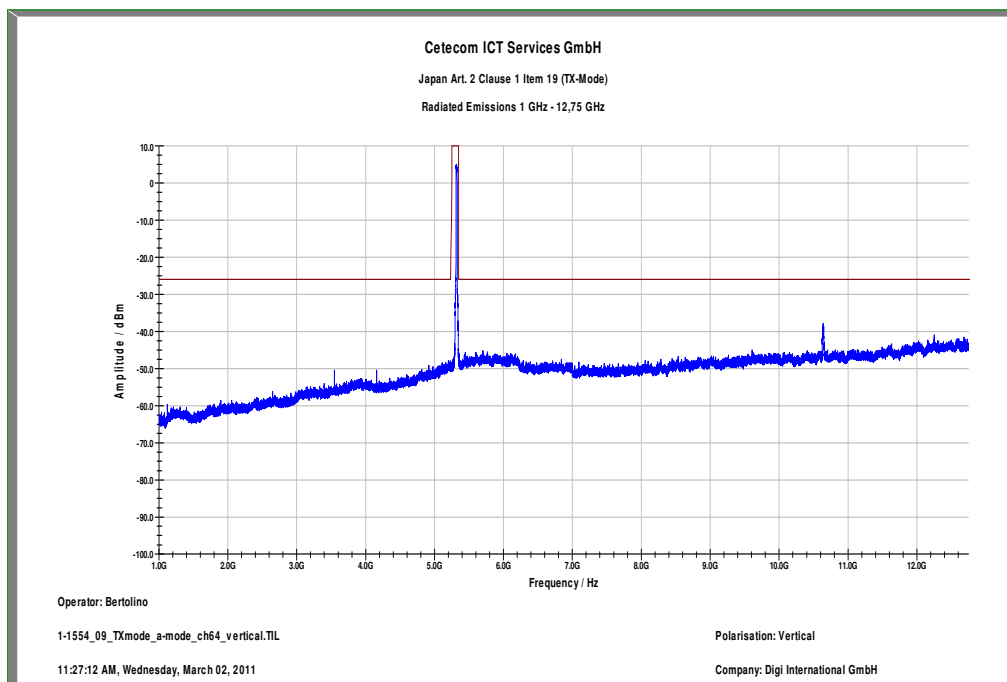

Plot 15: Highest channel – 5320 MHz; (30MHz – 1 GHz) – horizontal

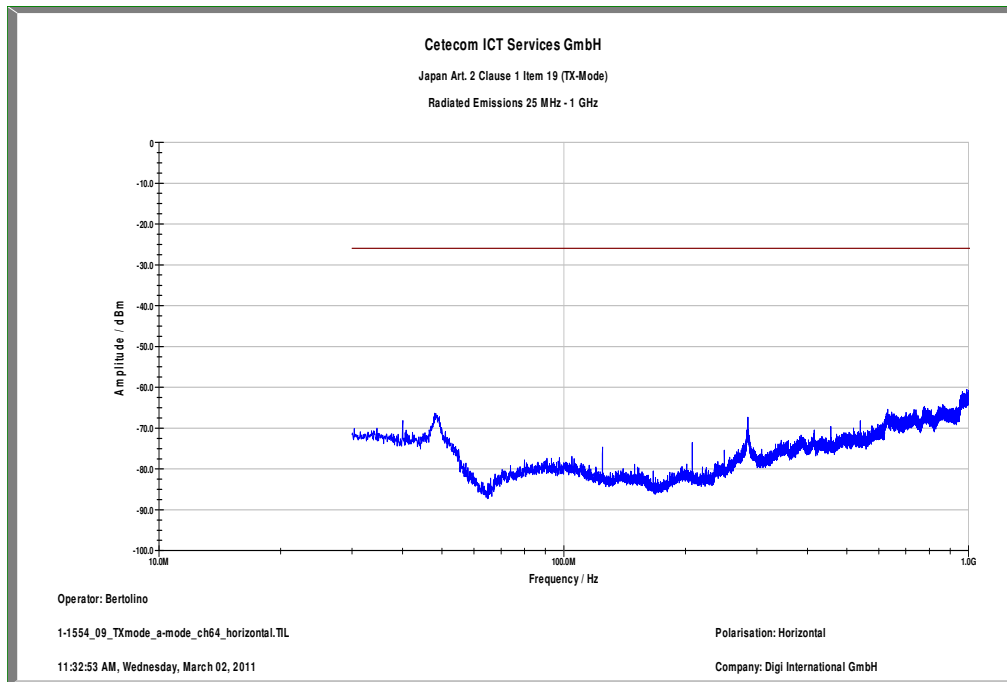

Plot 16: Highest channel – 5320 MHz; (1 GHz – 12.75 GHz) – horizontal

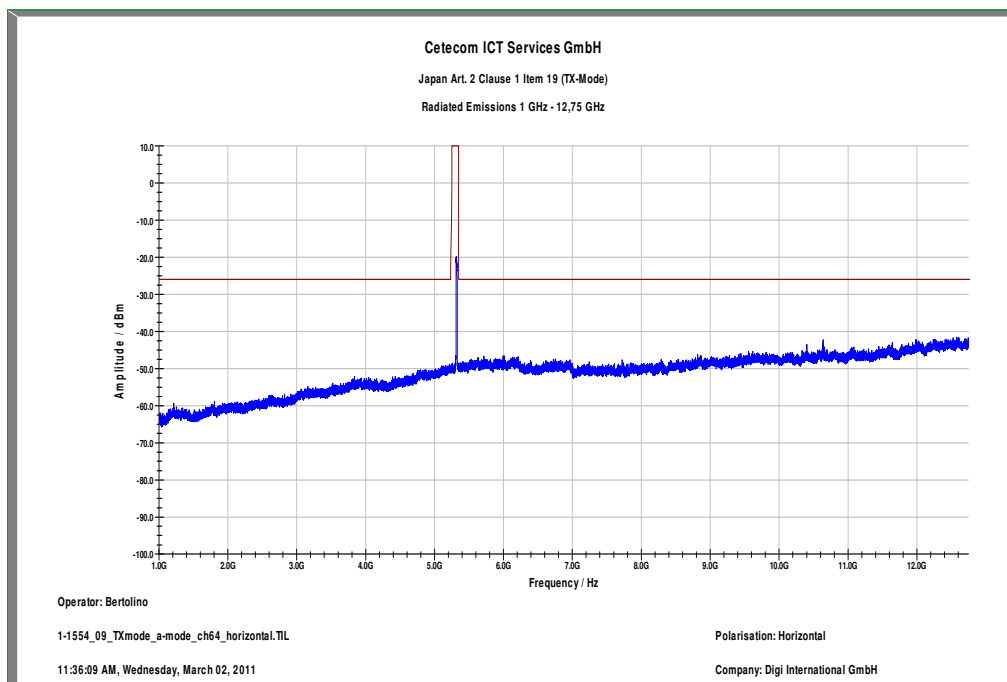

Plot 17: Highest channel – 5320 MHz; (12.75 GHz – 18 GHz) – vertical & horizontal

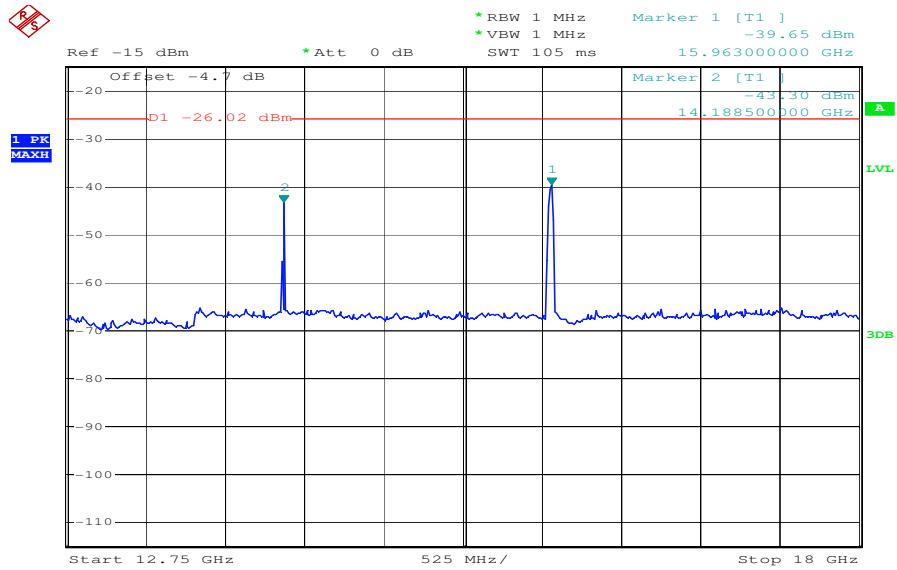

Date: 2.MAR.2011 13:55:28

Plot 18: Highest channel – 5320 MHz; (18 GHz – 26 GHz) – vertical & horizontal

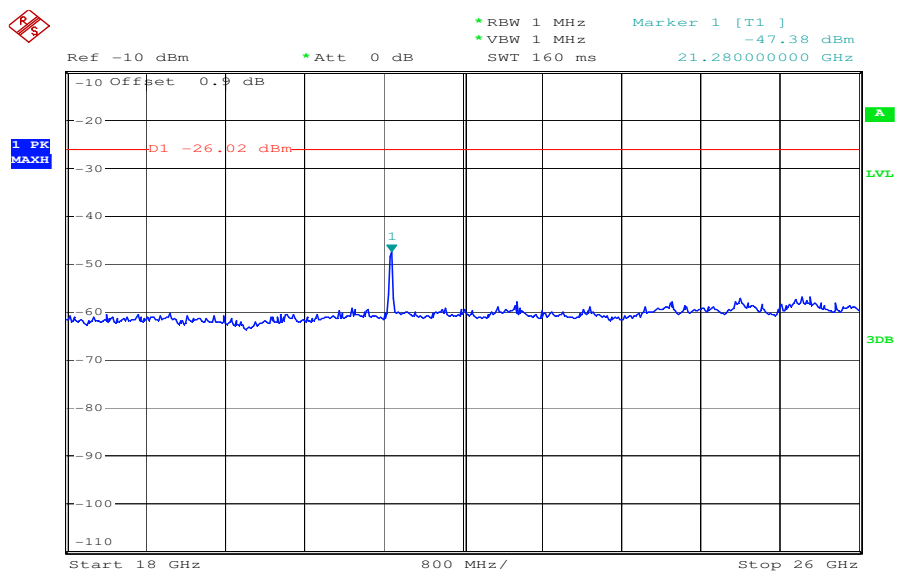

Date: 2.MAR.2011 14:26:38

Plots: OFDM / n – mode, band 1 and band 2

Band 1:

Plot 1: Lowest channel – 5180 MHz; (30MHz – 1 GHz) – vertical

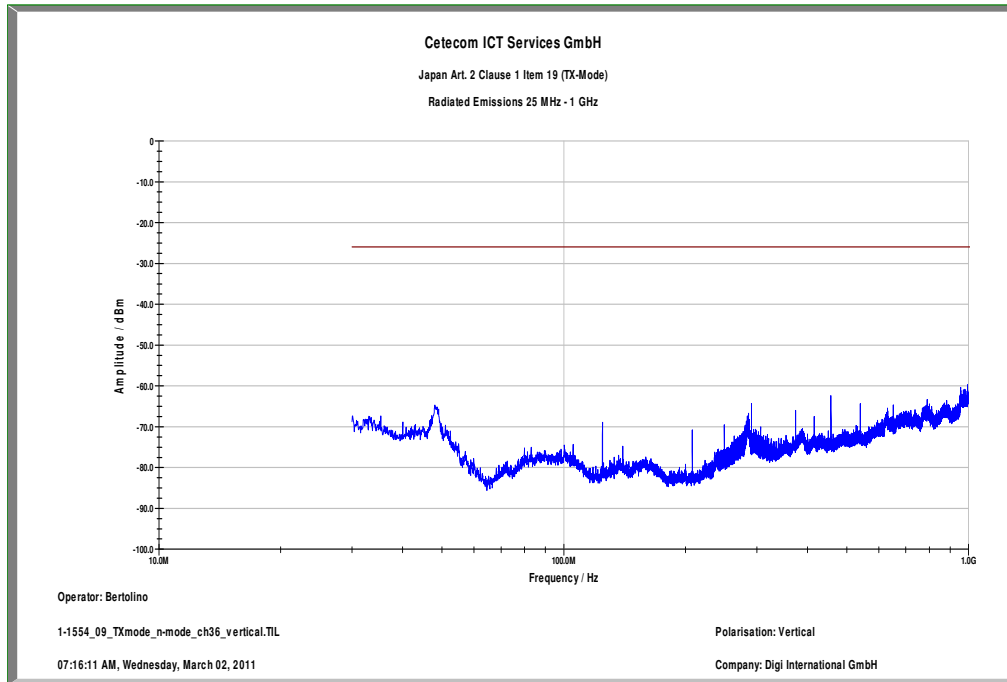

Plot 2: Lowest channel – 5180 MHz; (1 GHz – 12.75 GHz) – vertical

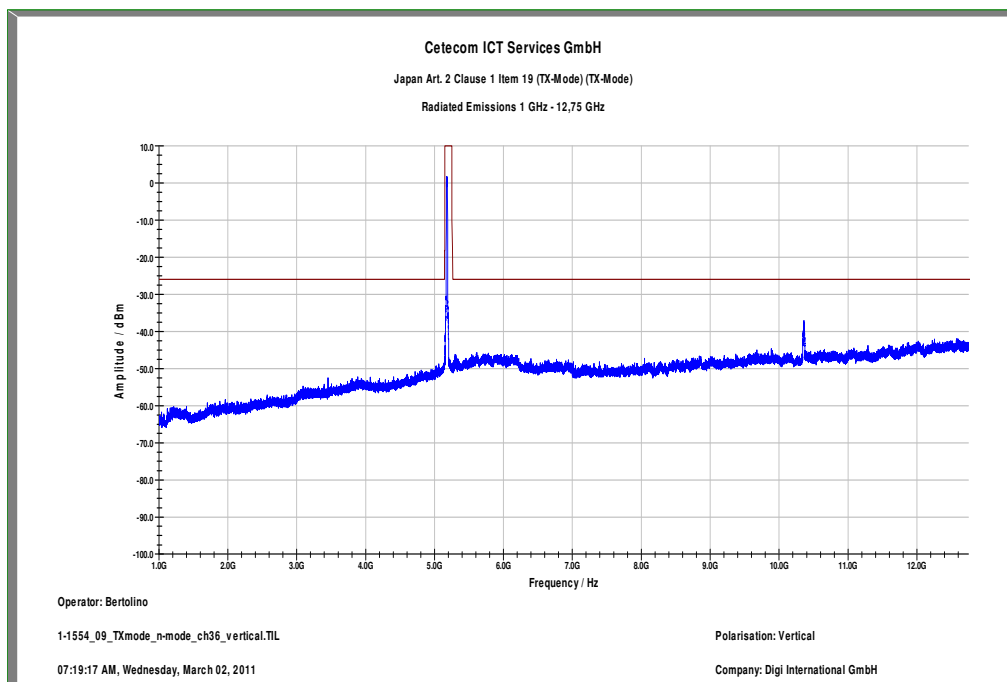

Plot 3: Lowest channel – 5180 MHz; (30MHz – 1 GHz) – horizontal

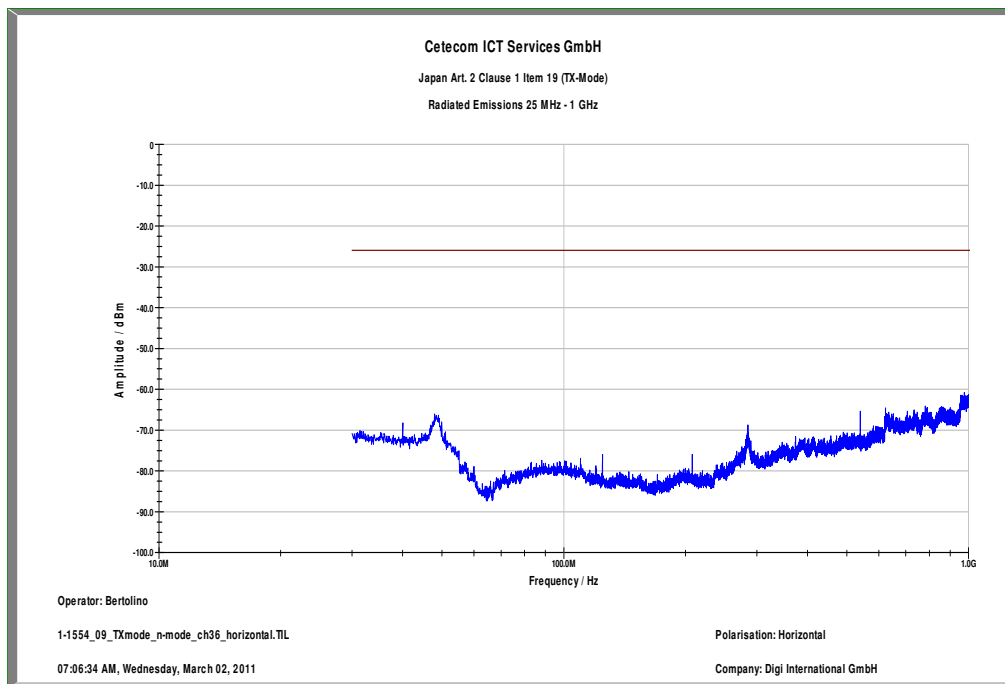

Plot 4: Lowest channel – 5180 MHz; (1 GHz – 12.75 GHz) – horizontal

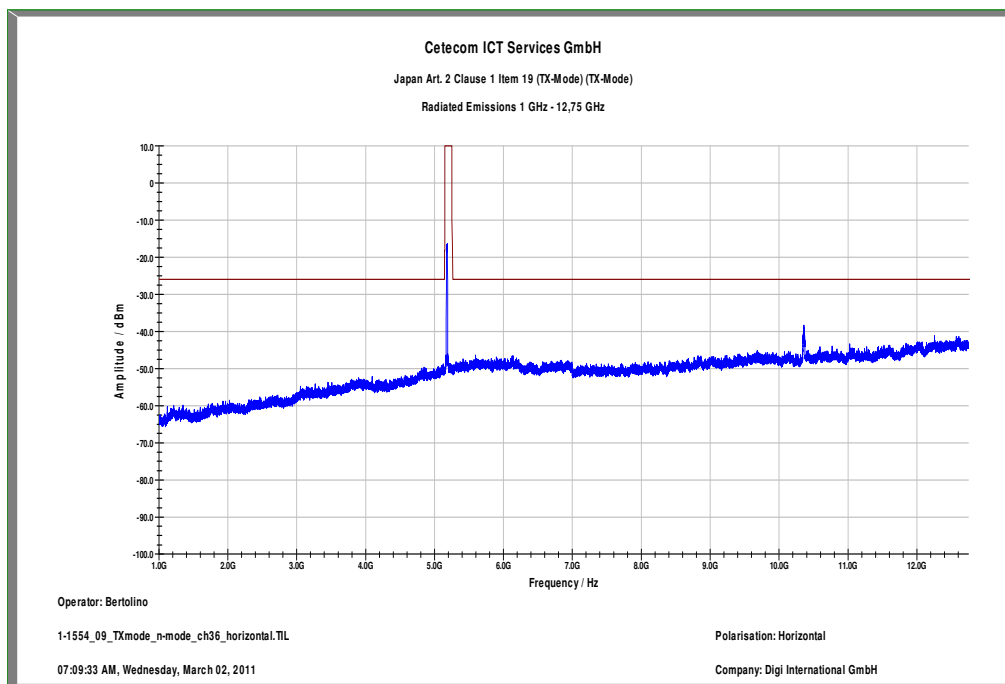

Plot 5: Lowest channel – 5180 MHz; (12.75 GHz – 18 GHz) – vertical & horizontal

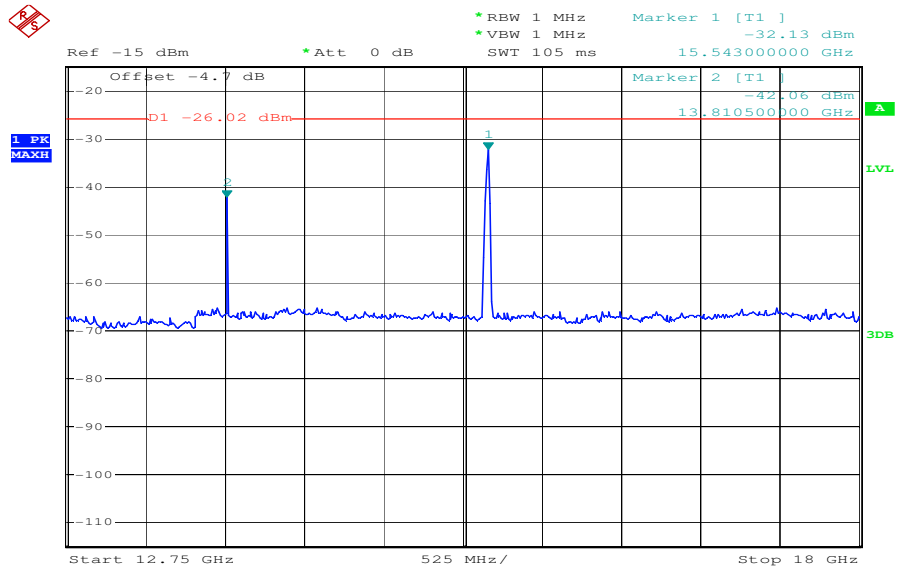

Date: 2.MAR.2011 13:40:26

Plot 6: Lowest channel – 5180 MHz; (18 GHz – 26 GHz) – vertical & horizontal

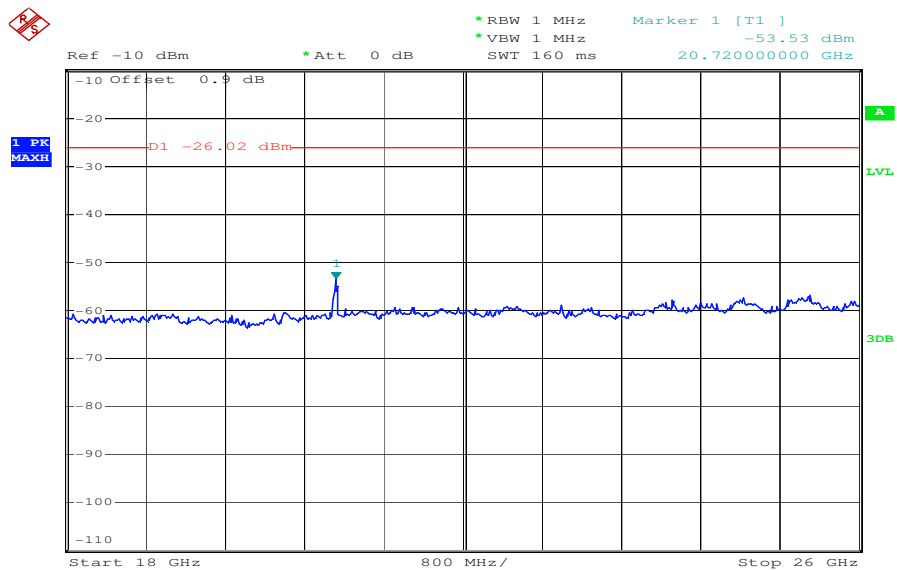

Date: 2.MAR.2011 14:17:19

Plot 7: Middle channel – 5200 MHz; (30MHz – 1 GHz) – vertical

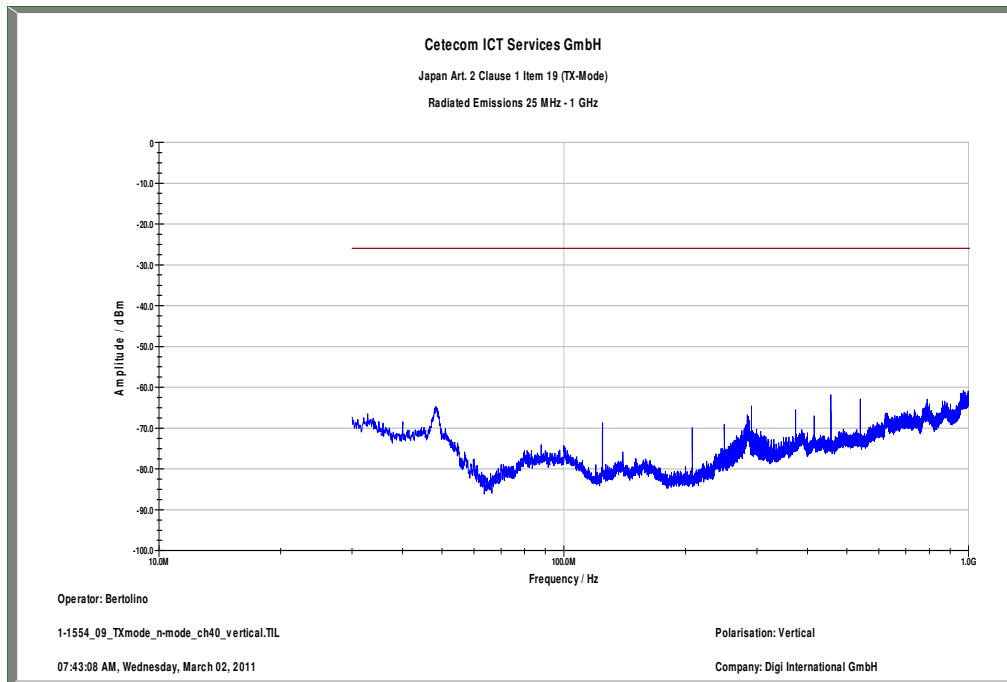

Plot 8: Middle channel – 5200 MHz; (1 GHz – 12.75 GHz) – vertical

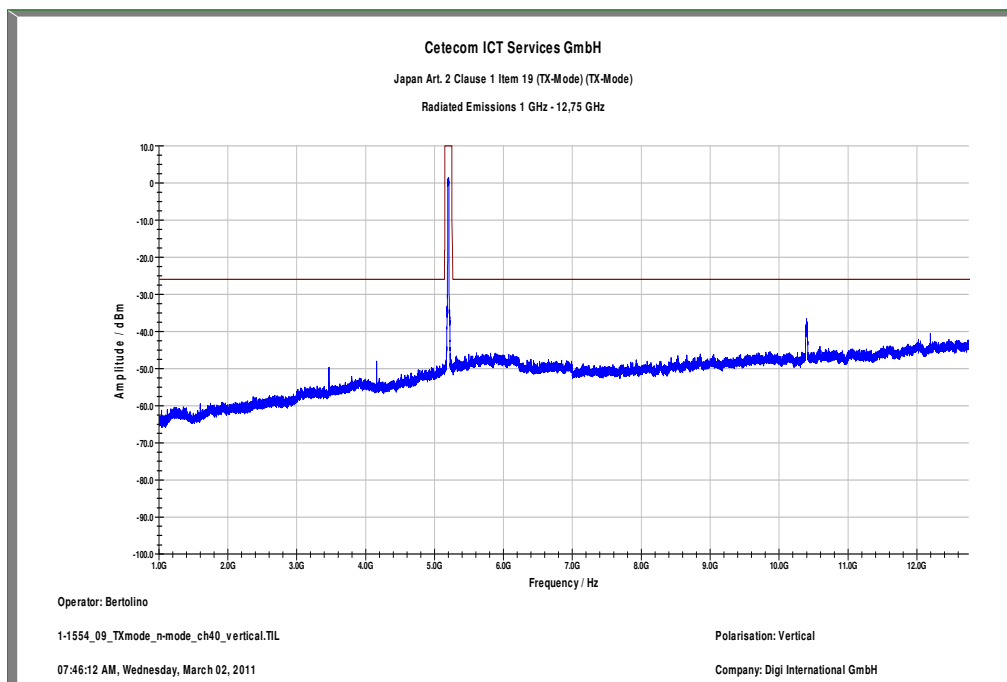

Plot 9: Middle channel – 5200 MHz; (30MHz – 1 GHz) – horizontal

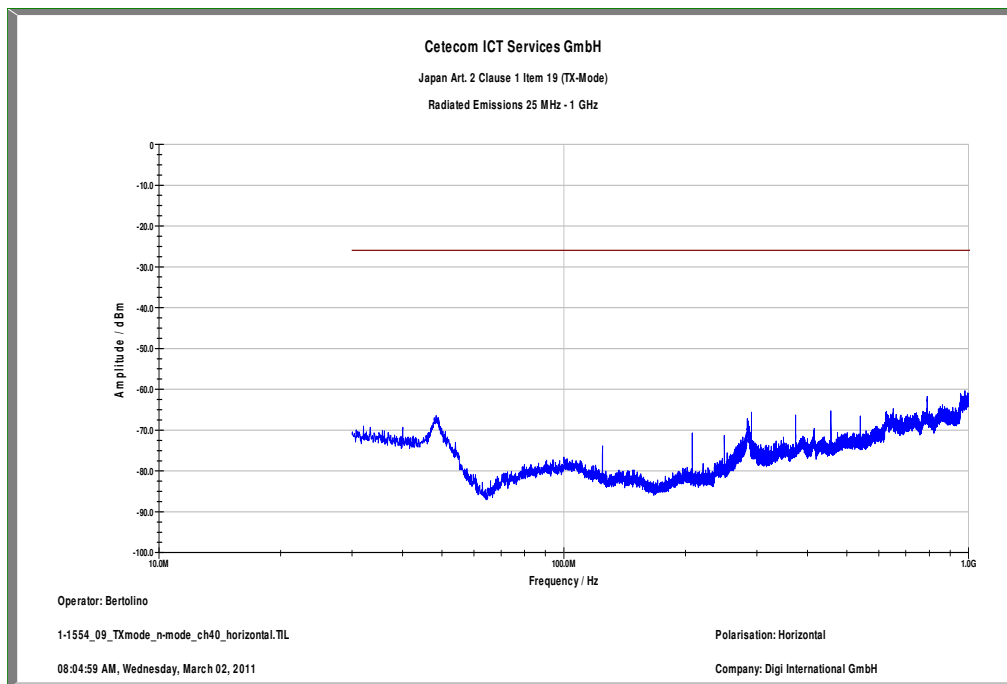

Plot 10: Middle channel – 5200 MHz; (1 GHz – 12.75 GHz) – horizontal

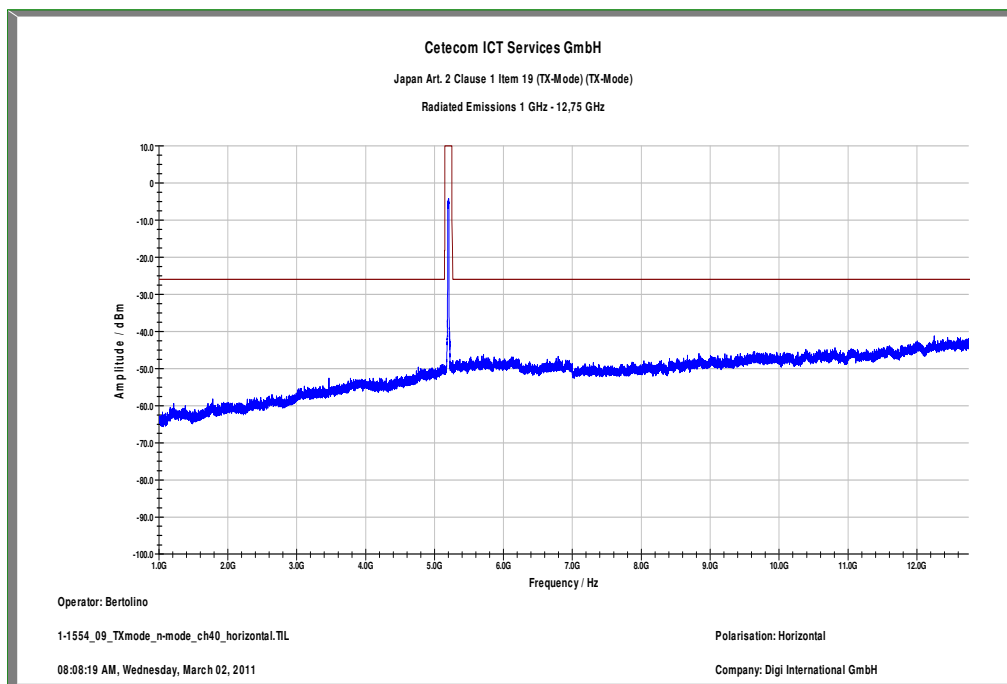

Plot 11: Middle channel – 5200 MHz; (12.75 GHz – 18 GHz) – vertical & horizontal

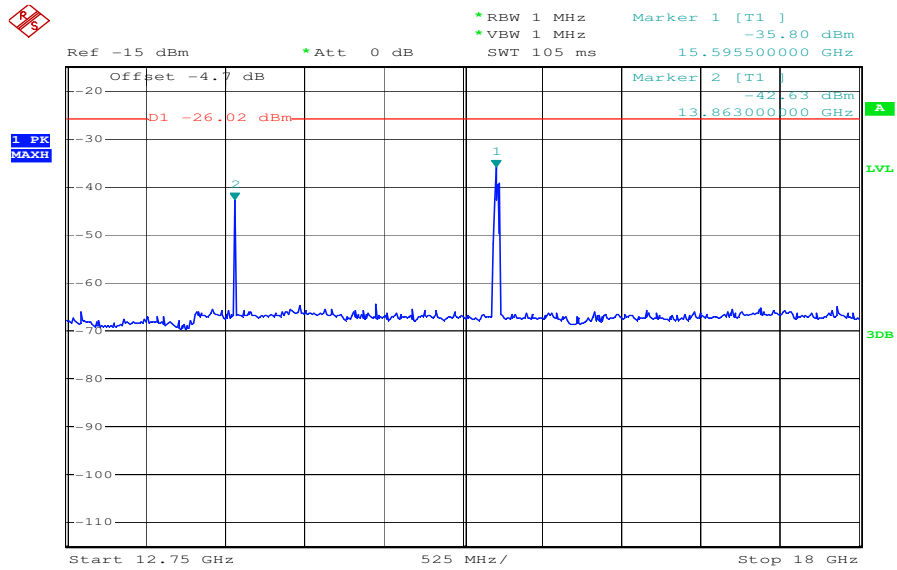

Date: 2.MAR.2011 13:43:55

Plot 12: Middle channel – 5200 MHz; (18 GHz – 26 GHz) – vertical & horizontal

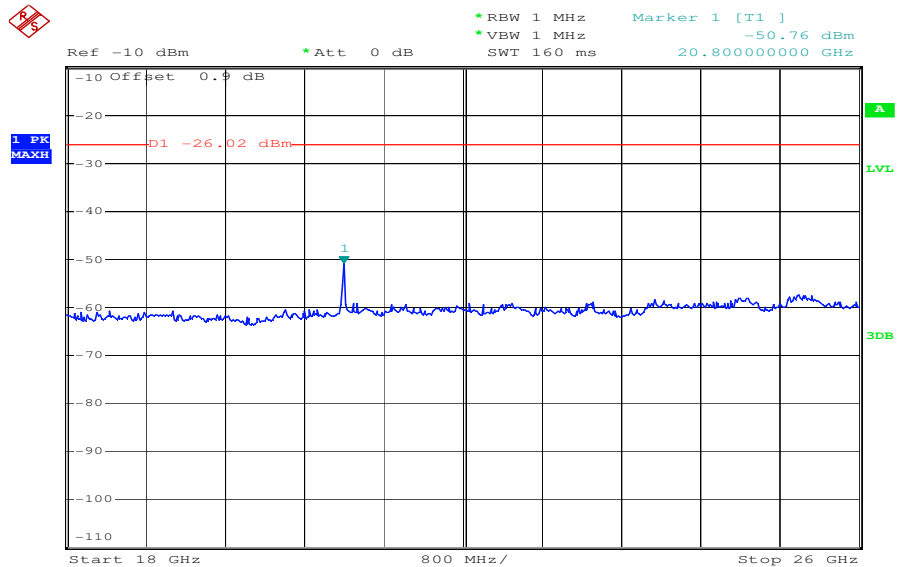

Date: 2.MAR.2011 14:20:56

Plot 13: Highest channel – 5240 MHz; (30MHz – 1 GHz) – vertical

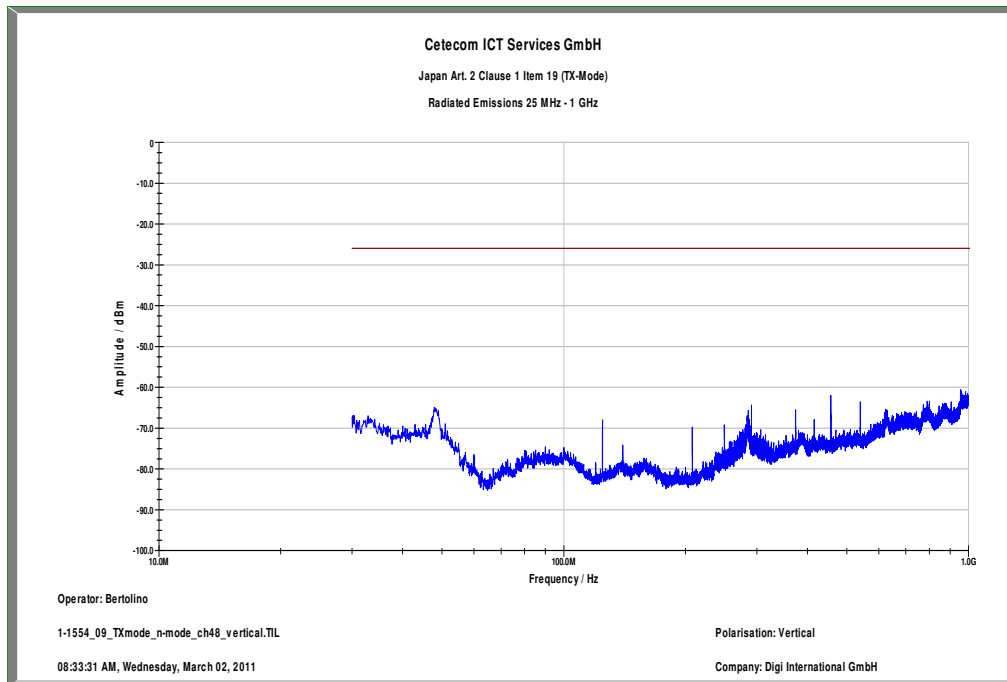

Plot 14: Highest channel – 5240 MHz; (1 GHz – 12.75 GHz) – vertical

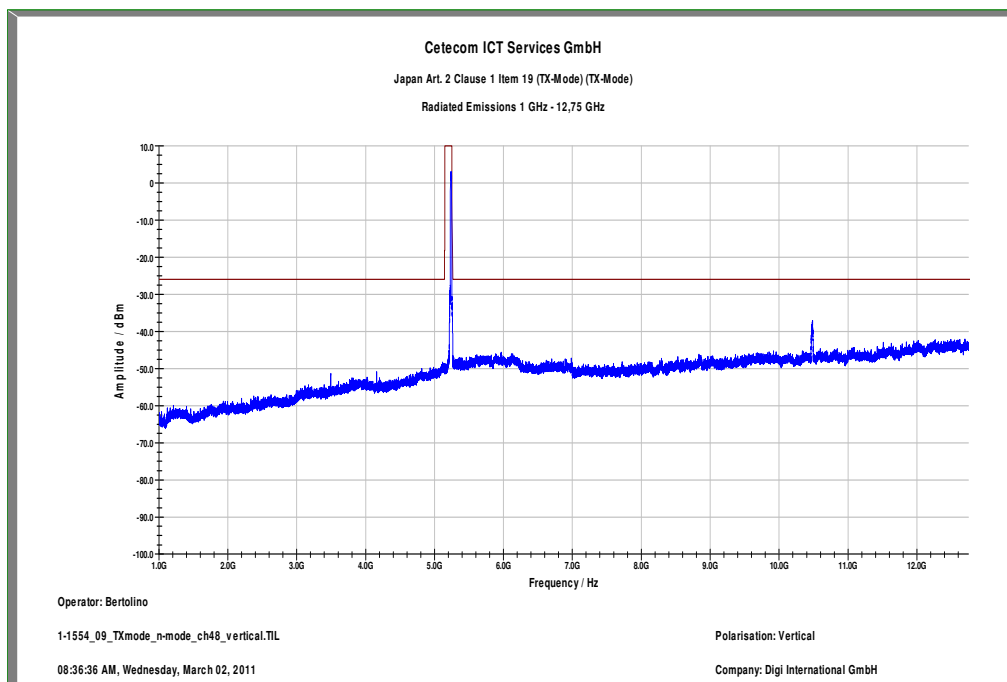

Plot 15: Highest channel – 5240 MHz; (30MHz – 1 GHz) – horizontal

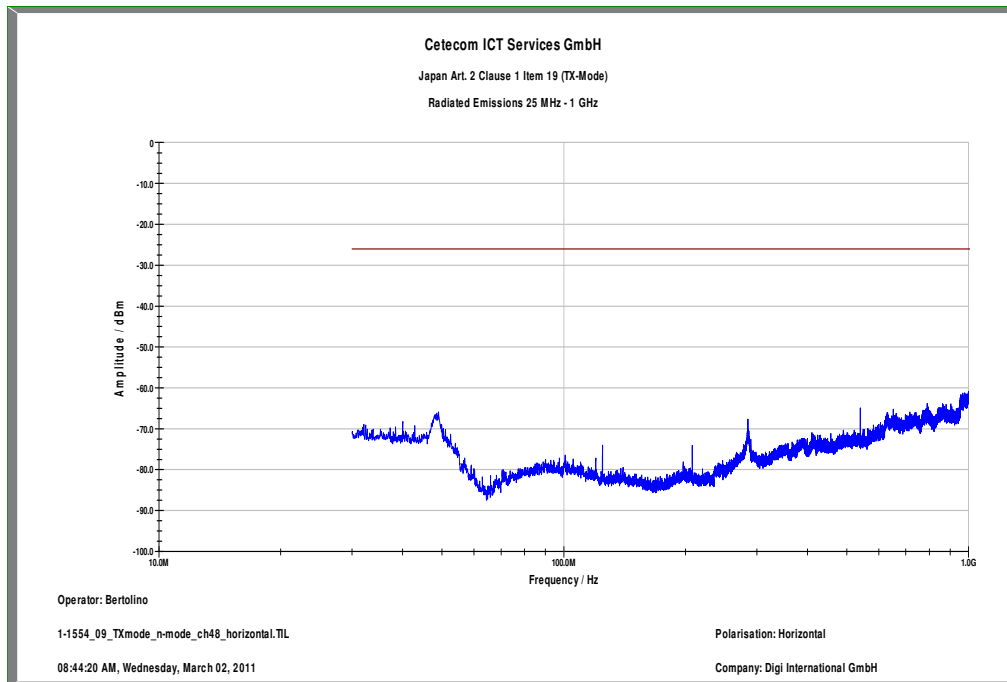

Plot 16: Highest channel – 5240 MHz; (1 GHz – 12.75 GHz) – horizontal

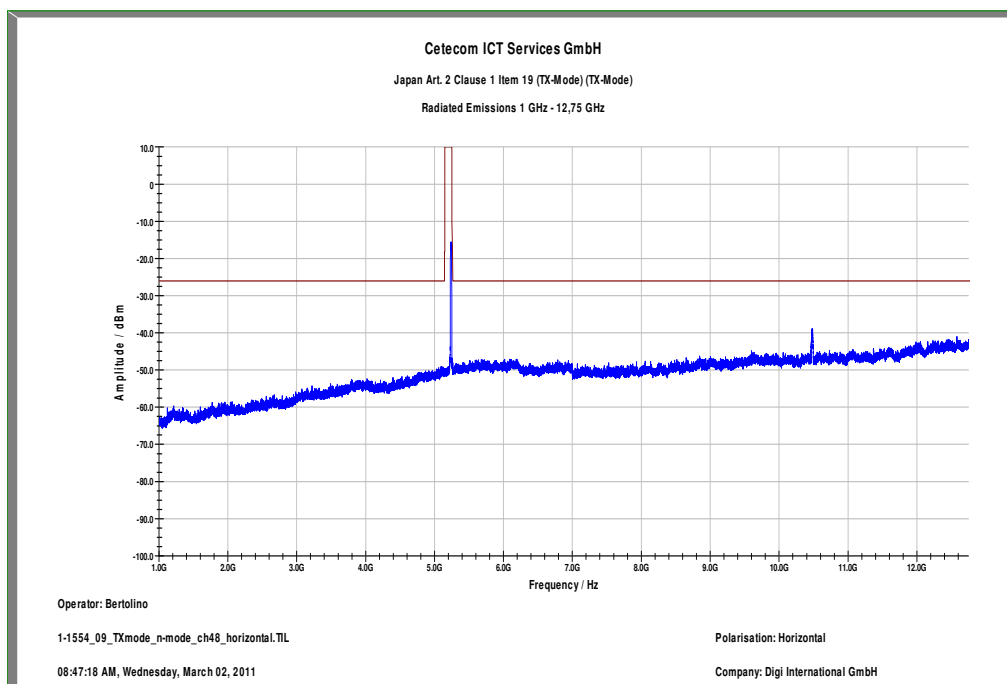

Plot 17: Highest channel – 5240 MHz; (12.75 GHz – 18 GHz) – vertical & horizontal

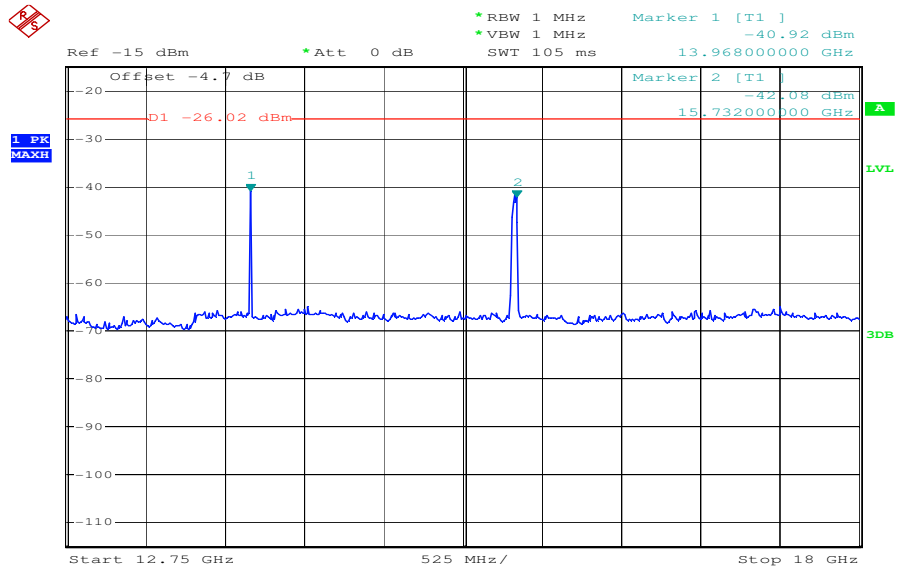

Date: 2.MAR.2011 13:47:17

Plot 18: Highest channel – 5240 MHz; (18 GHz – 26 GHz) – vertical & horizontal

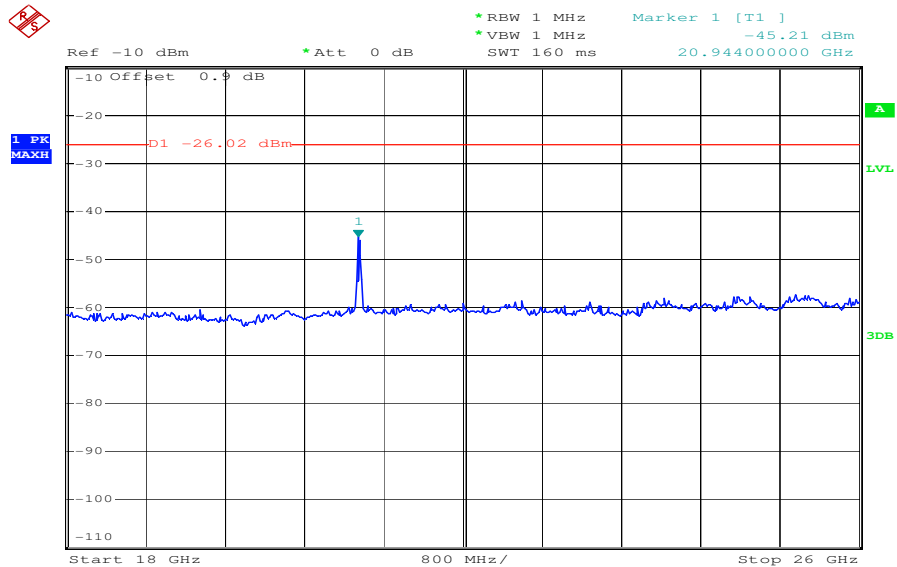

Date: 2.MAR.2011 14:22:33

Band 2:

Plot 1: Lowest channel – 5260 MHz; (30MHz – 1 GHz) – vertical

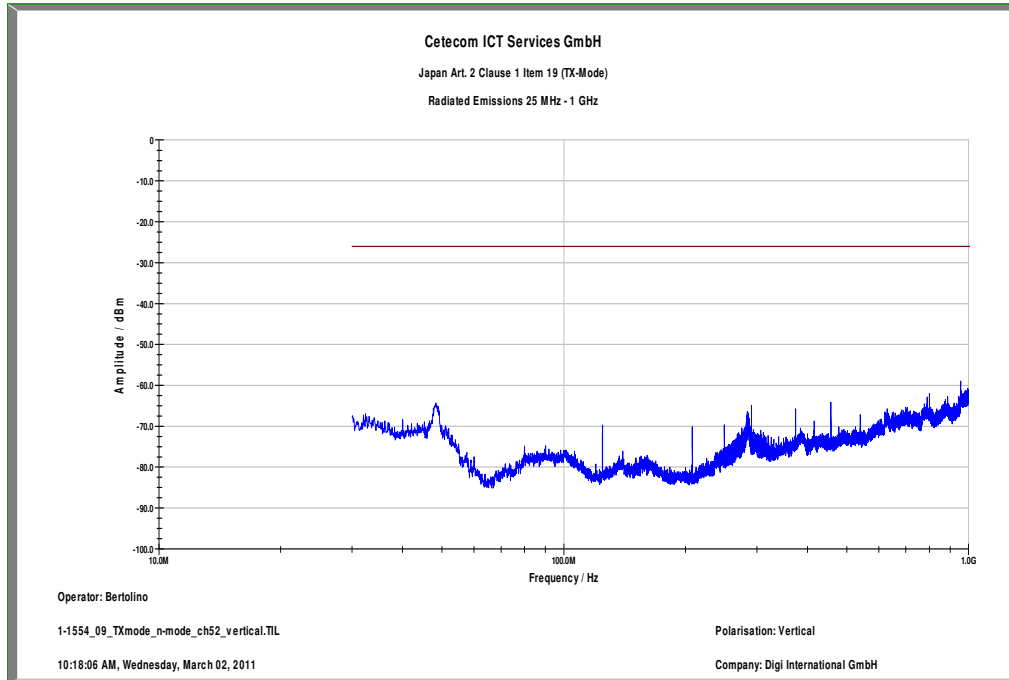

Plot 2: Lowest channel – 5260 MHz; (1 GHz – 12.75 GHz) – vertical

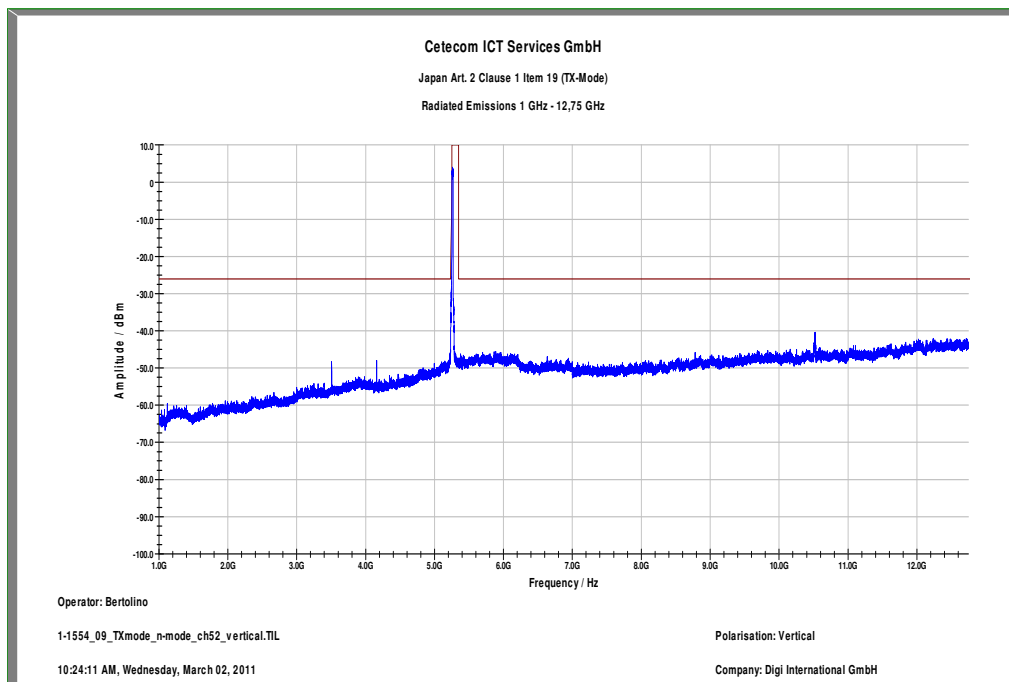

Plot 3: Lowest channel – 5260 MHz; (30MHz – 1 GHz) – horizontal

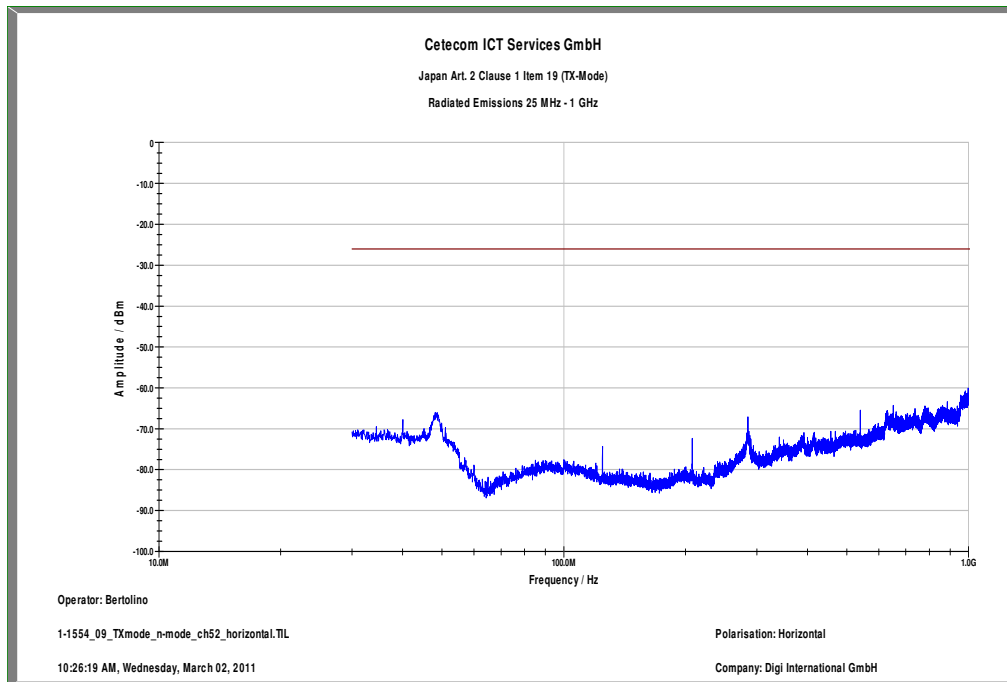

Plot 4: Lowest channel – 5260 MHz; (1 GHz – 12.75 GHz) – horizontal

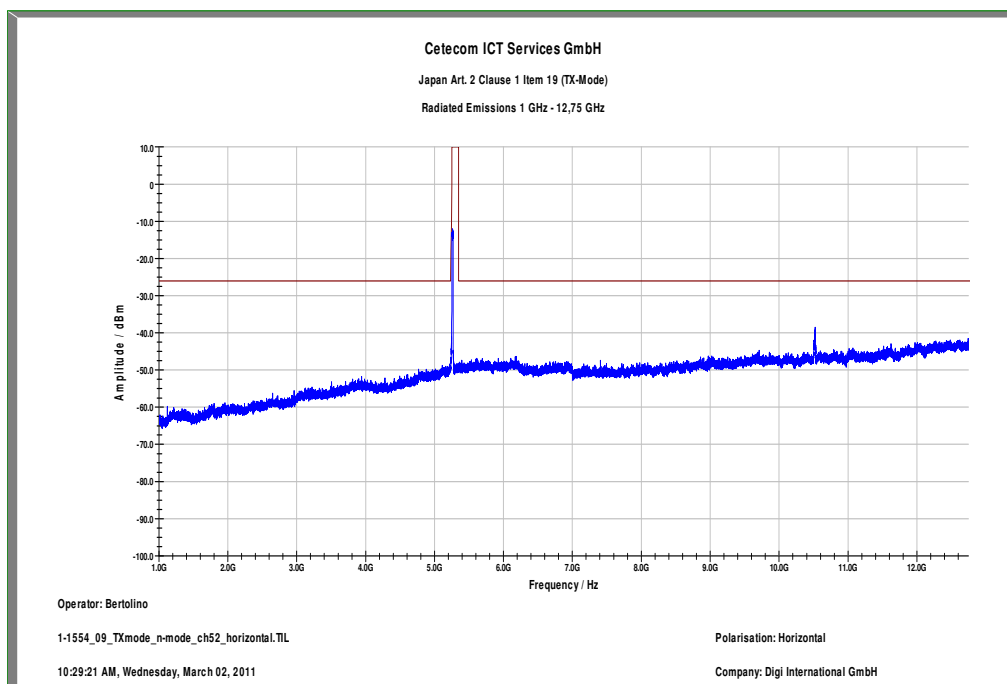

Plot 5: Lowest channel – 5260 MHz; (12.75 GHz – 18 GHz) – vertical & horizontal

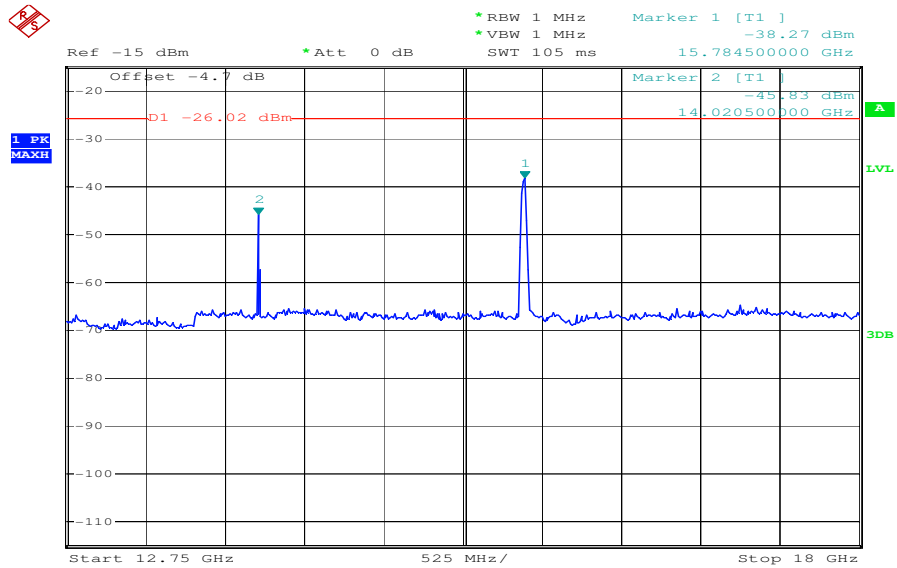

Date: 2.MAR.2011 13:49:49

Plot 6: Lowest channel – 5260 MHz; (18 GHz – 26 GHz) – vertical & horizontal

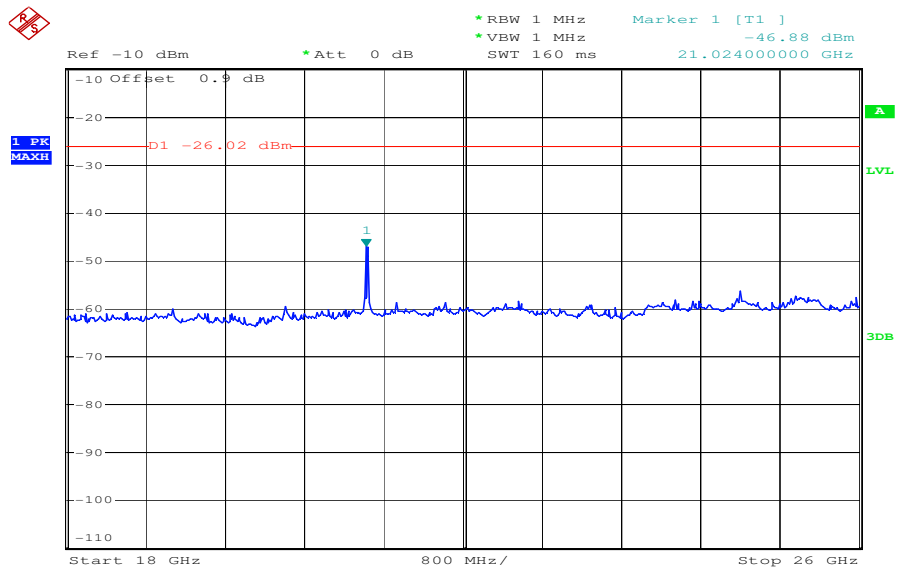

Date: 2.MAR.2011 14:24:05

Plot 7: Middle channel – 5280 MHz; (30MHz – 1 GHz) – vertical

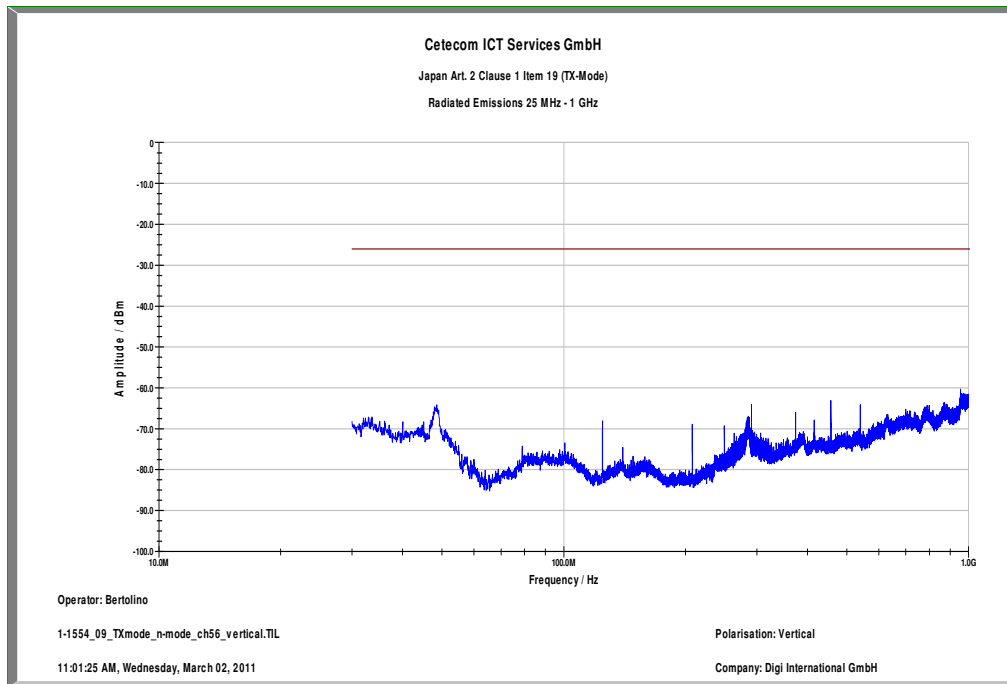

Plot 8: Middle channel – 5280 MHz; (1 GHz – 12.75 GHz) – vertical

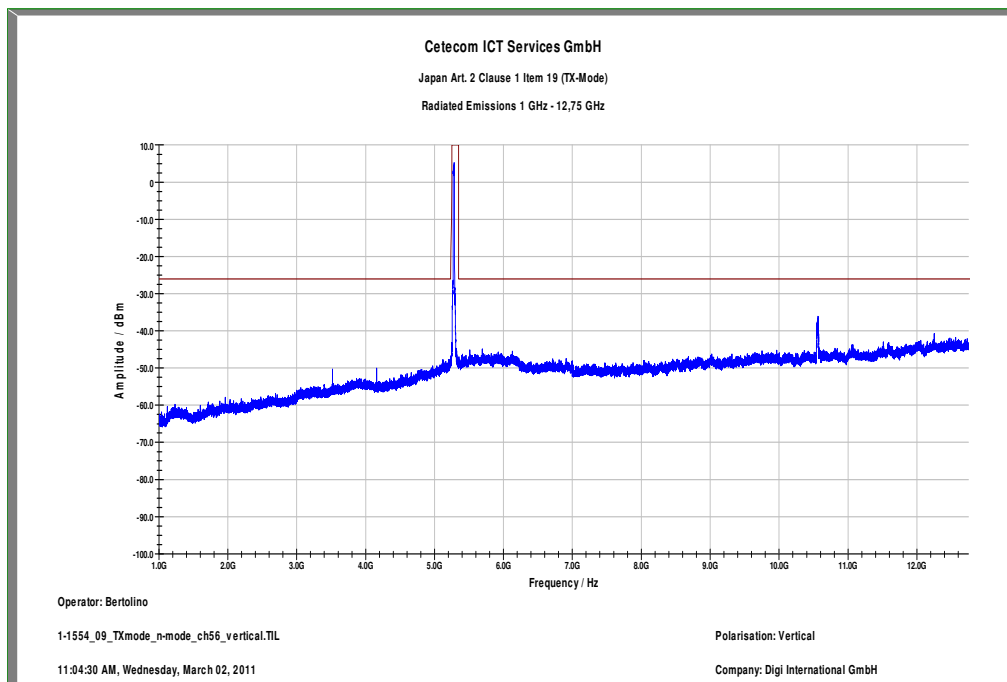

Plot 9: Middle channel – 5280 MHz; (30MHz – 1 GHz) – horizontal

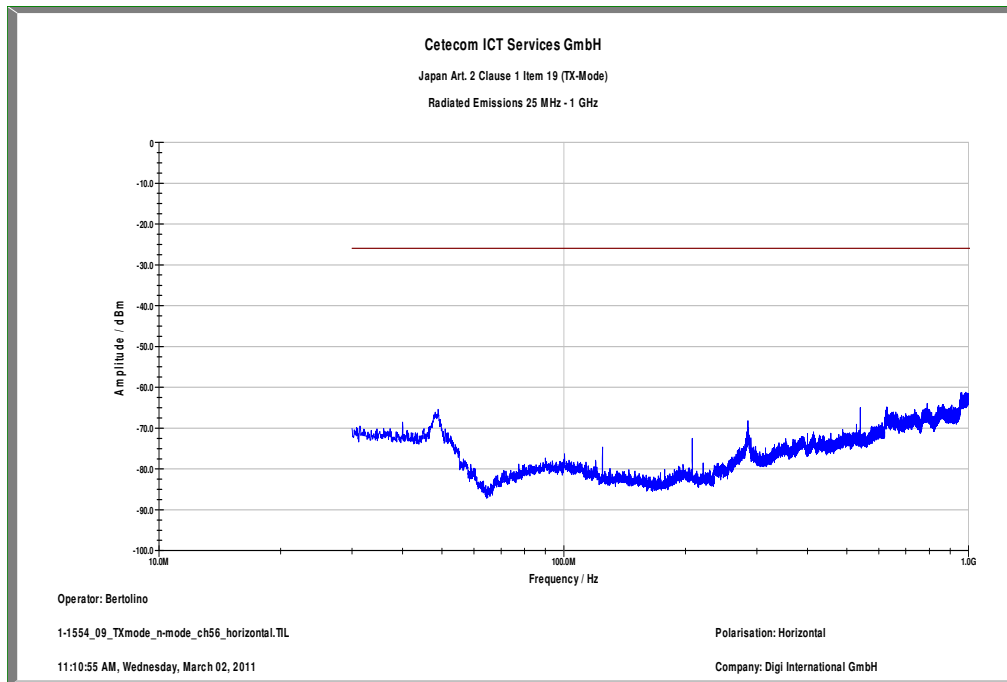

Plot 10: Middle channel – 5280 MHz; (1 GHz – 12.75 GHz) – horizontal

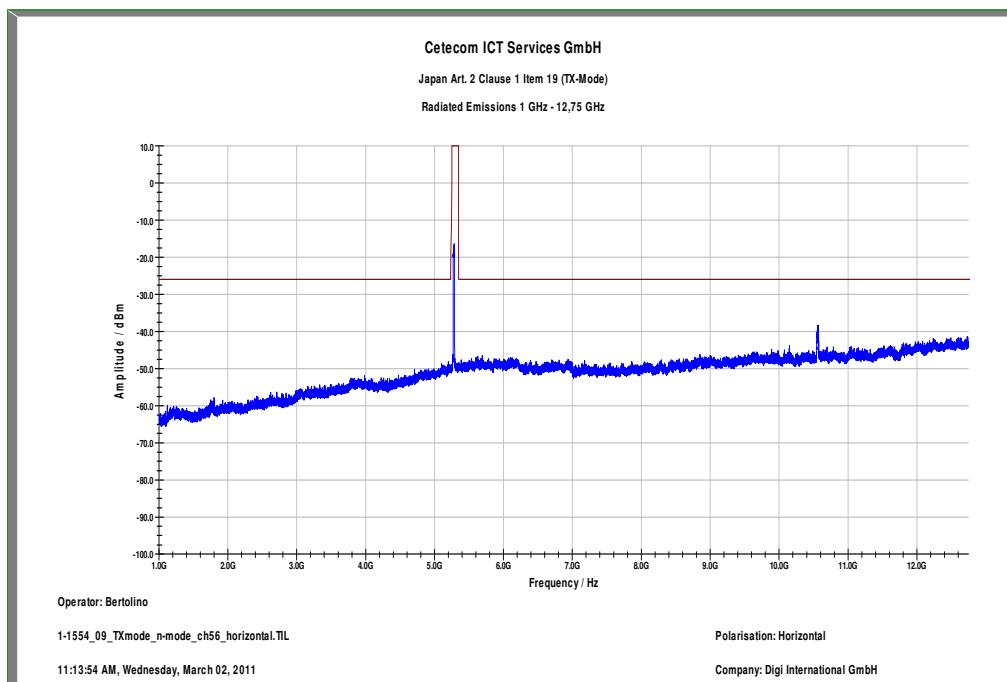

Plot 11: Middle channel – 5280 MHz; (12.75 GHz – 18 GHz) – vertical & horizontal

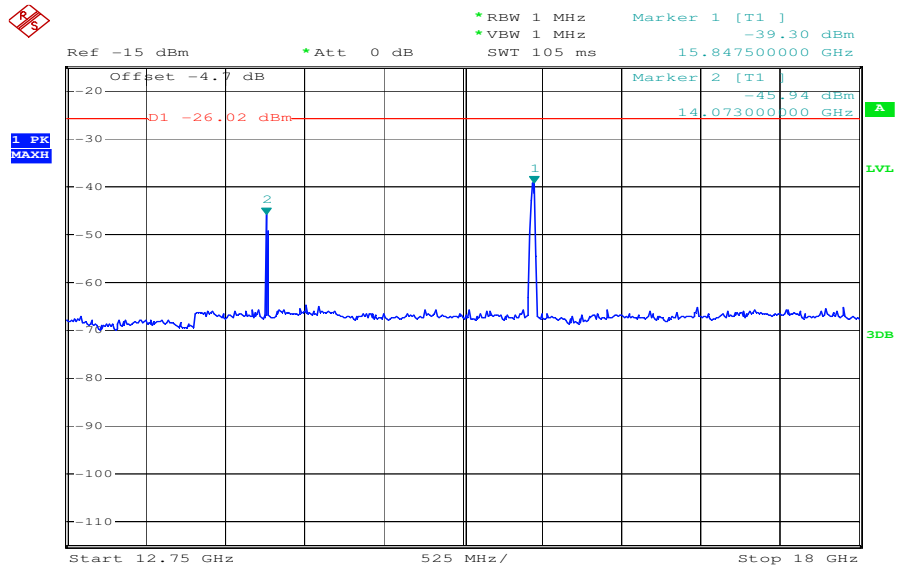

Date: 2.MAR.2011 13:53:01

Plot 12: Middle channel – 5280 MHz; (18 GHz – 26 GHz) – vertical & horizontal

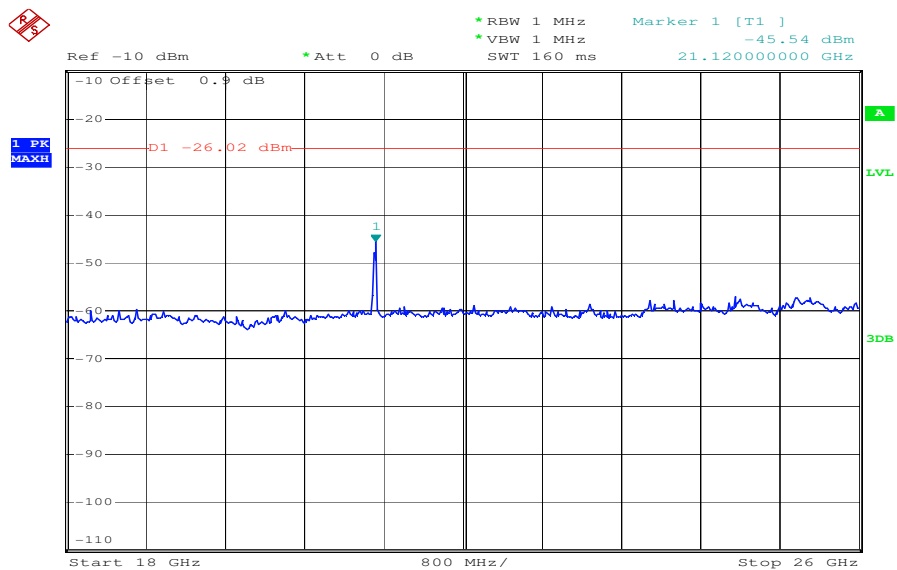

Date: 2.MAR.2011 14:25:40

Plot 13: Highest channel – 5320 MHz; (30MHz – 1 GHz) – vertical

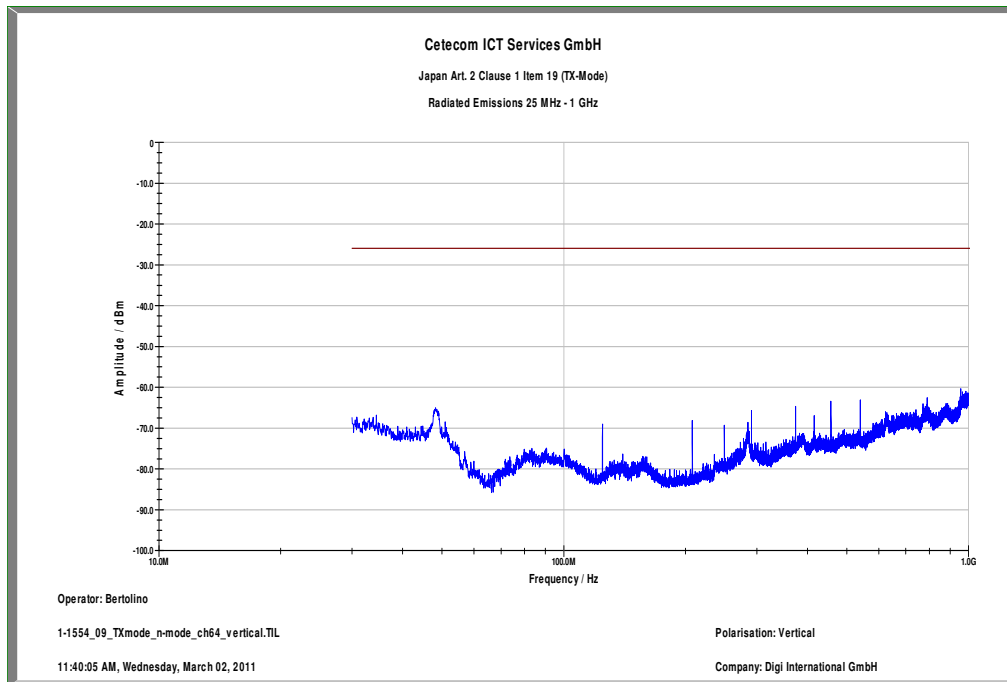

Plot 14: Highest channel – 5320 MHz; (1 GHz – 12.75 GHz) – vertical

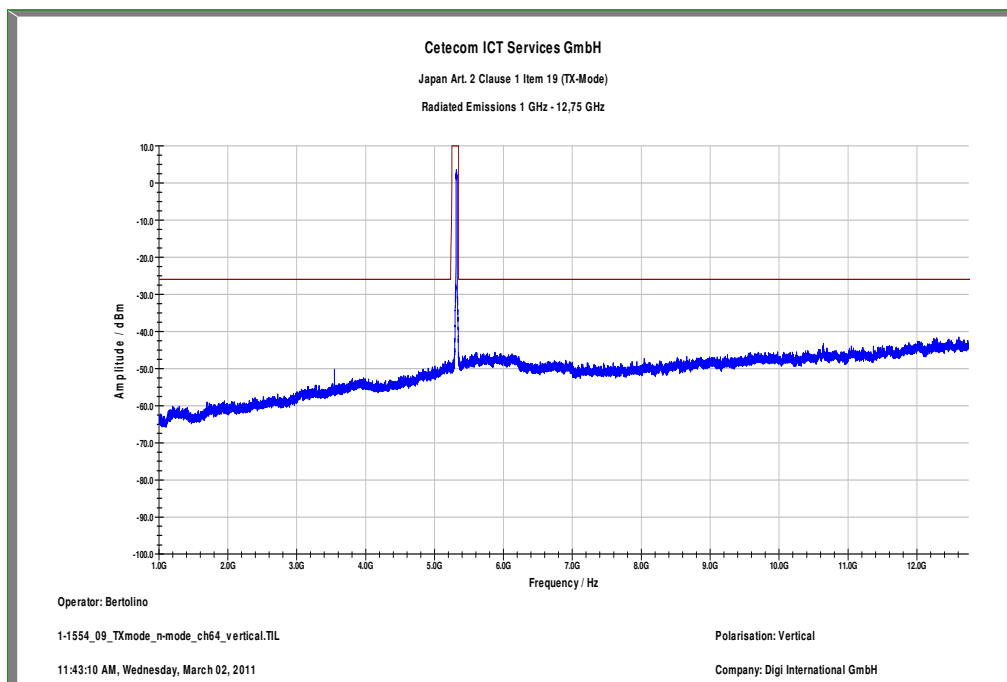

Plot 15: Highest channel – 5320 MHz; (30MHz – 1 GHz) – horizontal

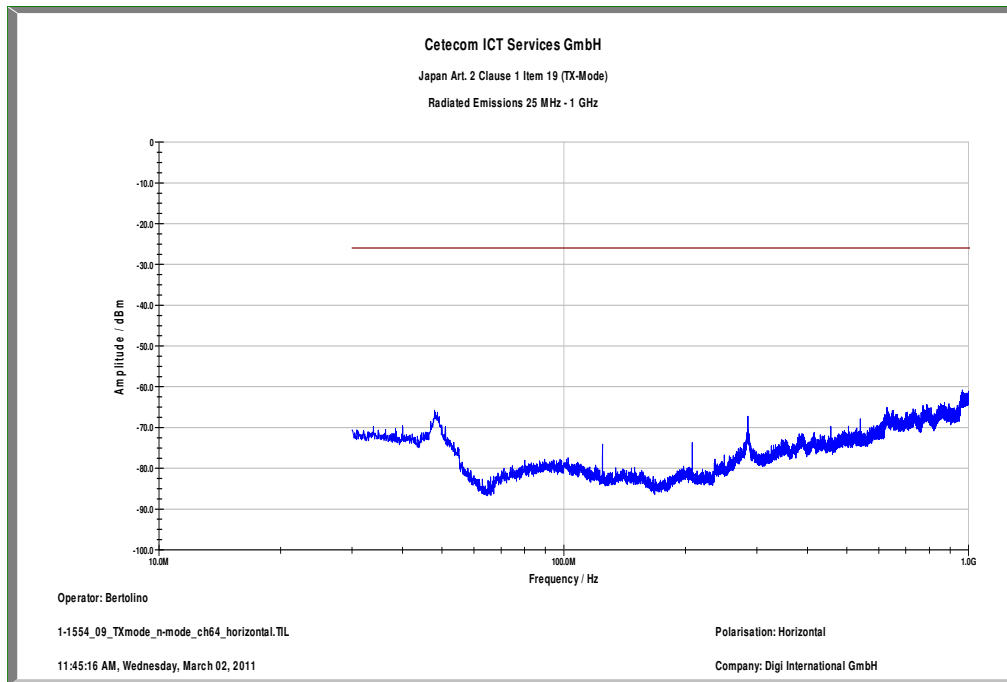

Plot 16: Highest channel – 5320 MHz; (1 GHz – 12.75 GHz) – horizontal

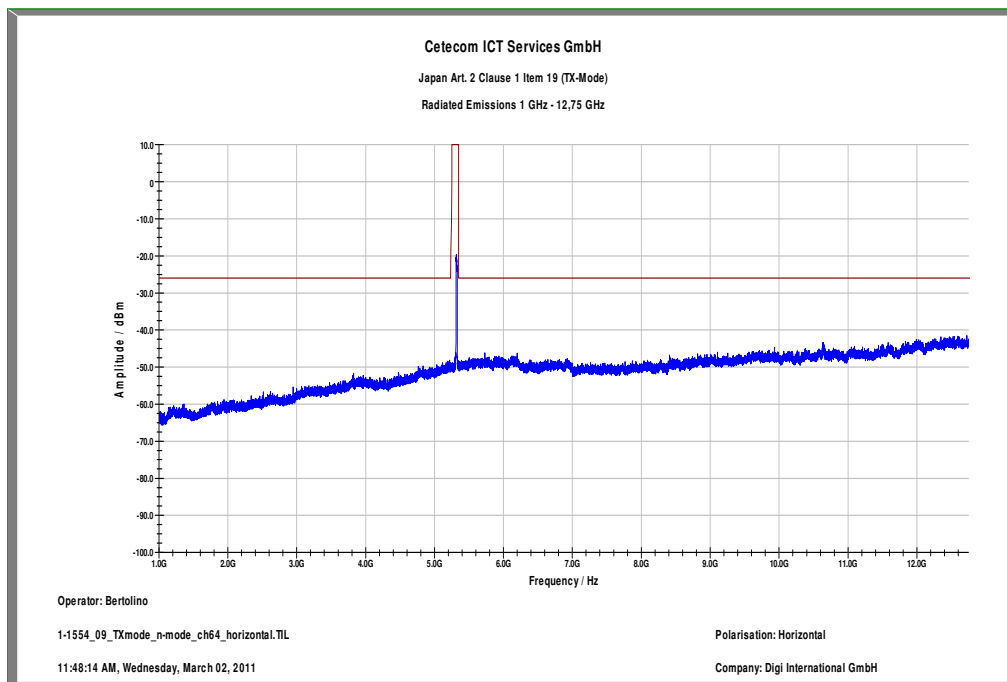

Plot 17: Highest channel – 5320 MHz; (12.75 GHz – 18 GHz) – vertical & horizontal

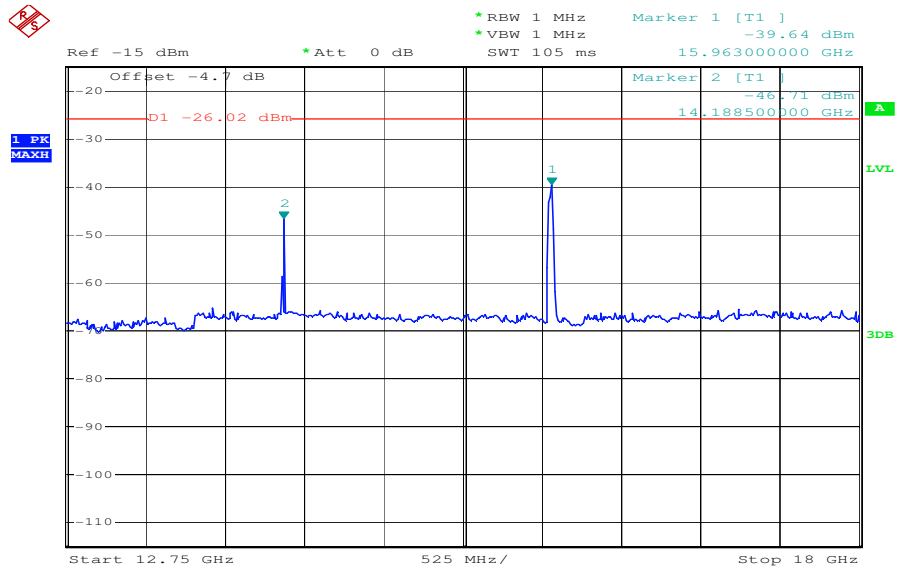

Date: 2.MAR.2011 13:56:27

Plot 18: Highest channel – 5320 MHz; (18 GHz – 26 GHz) – vertical & horizontal

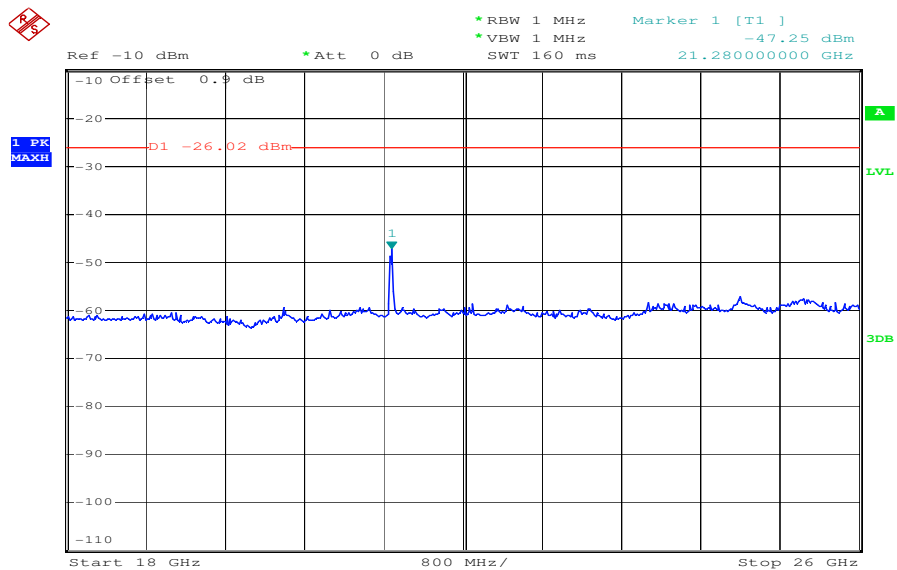

Date: 2.MAR.2011 14:28:17

9.8 Occupied & spreading bandwidth

Measurement parameter:

Measurement parameter	
Detector:	Peak
Sweep time:	Auto
Resolution bandwidth:	10 kHz (less than 3% of the acceptable value)
Video bandwidth:	10 kHz (comparable to RBW)
Span:	40 MHz (2-3.5 times of the acceptable value)
Trace-Mode:	Max Hold
Additional EUT parameters:	Power index 21 OFDM a & n – mode

Results: OFDM a – mode, band 1

	lowest channel 5180 MHz	middle channel 5200 MHz	highest channel 5240 MHz
Spreading bandwidth [MHz] (90% bandwidth)	16.64	16.64	16.64
Occupied bandwidth [MHz] (99% bandwidth)	17.60	17.60	17.76

Results: OFDM a – mode, band 2

	lowest channel 5260 MHz	middle channel 5280 MHz	highest channel 5320 MHz
Spreading bandwidth [MHz] (90% bandwidth)	16.64	16.64	16.72
Occupied bandwidth [MHz] (99% bandwidth)	17.76	17.76	17.84

Results: OFDM n – mode, band 1

	lowest channel 5180 MHz	middle channel 5200 MHz	highest channel 5240 MHz
Spreading bandwidth [MHz] (90% bandwidth)	17.84	17.92	17.92
Occupied bandwidth [MHz] (99% bandwidth)	18.80	18.56	18.96

Results: OFDM n – mode, band 2

	lowest channel 5260 MHz	middle channel 5280 MHz	highest channel 5320 MHz
Spreading bandwidth [MHz] (90% bandwidth)	17.92	17.92	17.92
Occupied bandwidth [MHz] (99% bandwidth)	18.72	18.56	18.72

Limit:

Limit Occupied Bandwidth	< 19 MHz
Limit Spreading Bandwidth	> 500 kHz

Result: [The result of the measurement is passed.](#)

Plots: OFDM / a – mode, power index 21, 54 MBit/s, band 1

Plot 1: OFDM (lowest channel – 5180 MHz, 90% bandwidth)

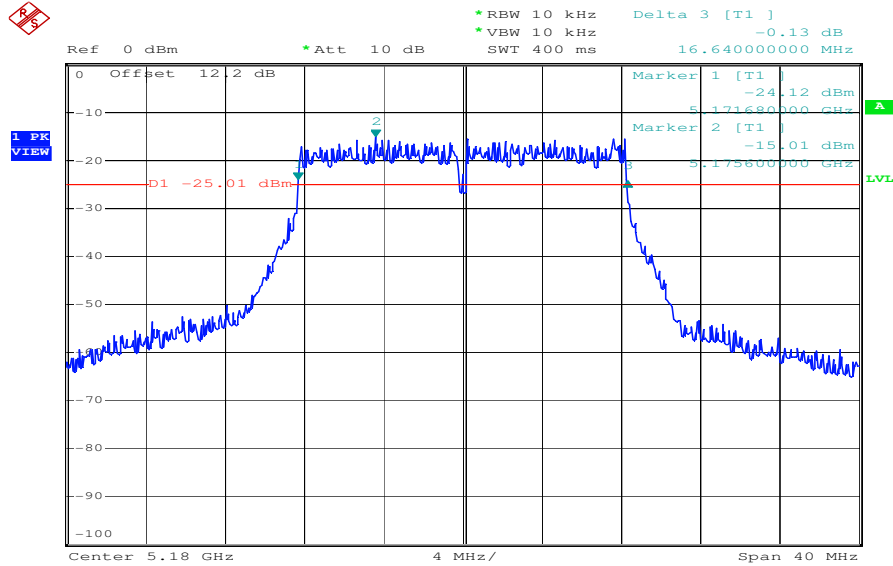

Date: 24.FEB.2011 08:02:44

Plot 2: OFDM (lowest channel – 5180 MHz, 99% bandwidth)

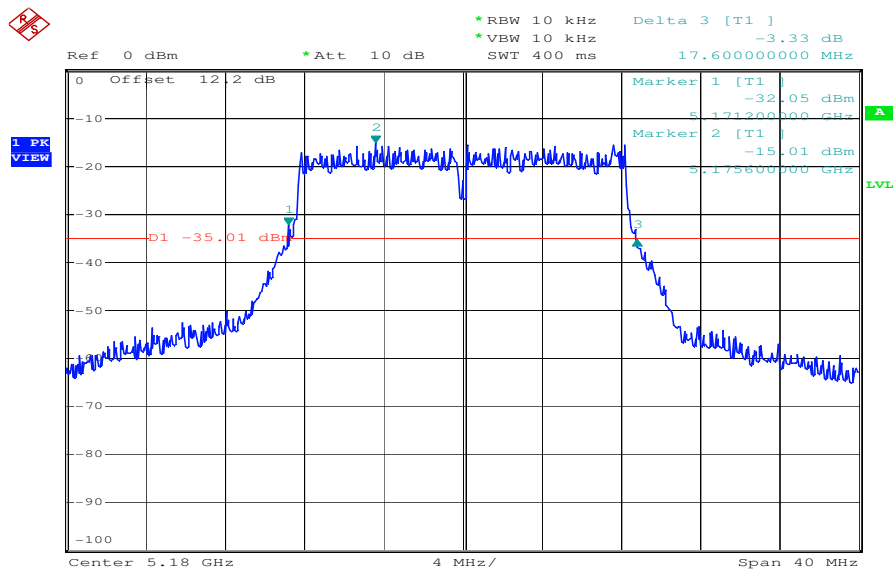

Date: 24.FEB.2011 08:02:12

Plot 3: OFDM (middle channel – 5200 MHz, 90%bandwidth)

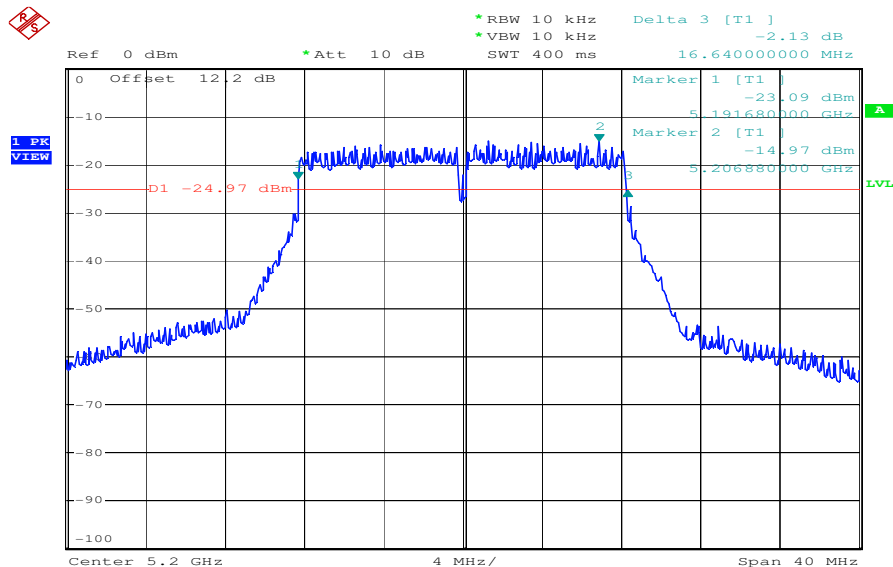

Date: 24.FEB.2011 08:05:26

Plot 4: OFDM (middle channel – 5200 MHz, 99%bandwidth)

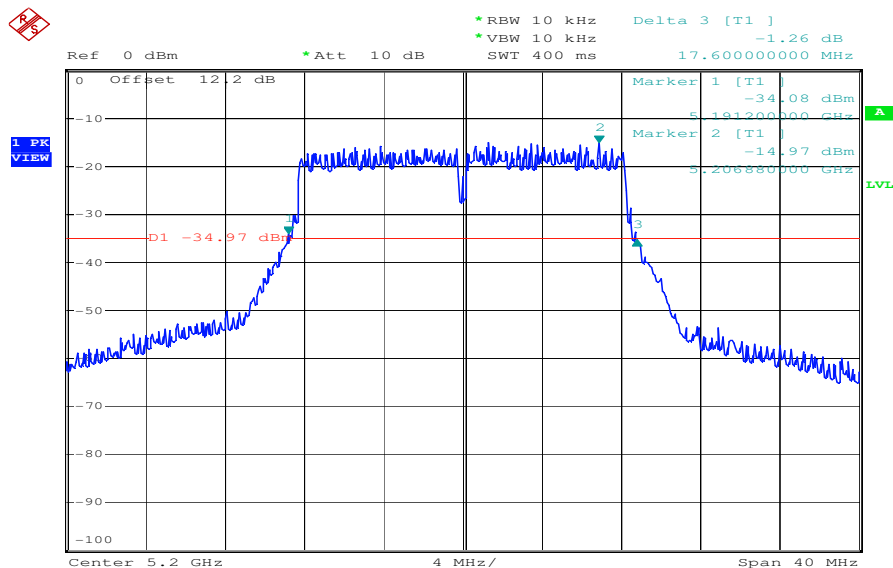

Date: 24.FEB.2011 08:05:52

Plot 5: OFDM (highest channel – 5240 MHz, 90%bandwidth)

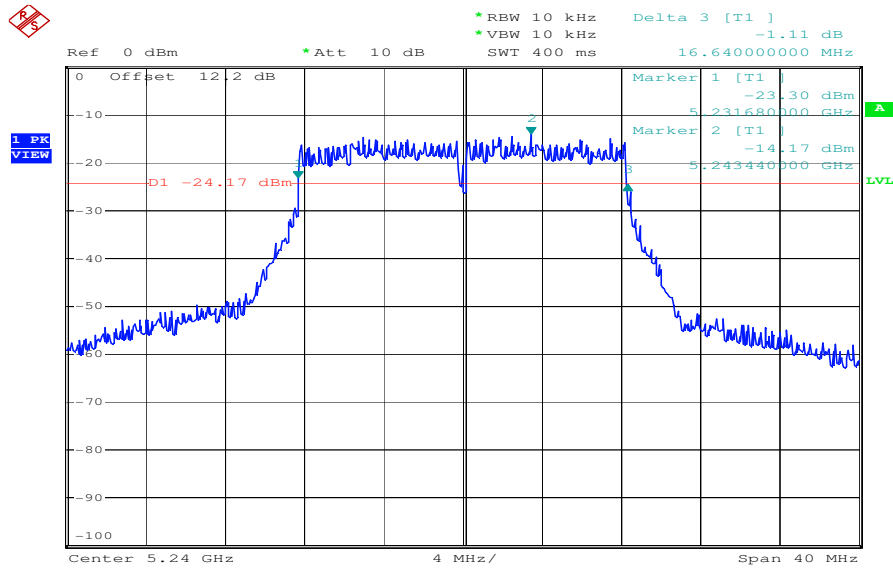

Date: 24.FEB.2011 08:18:26

Plot 6: OFDM (highest channel – 5240 MHz, 99%bandwidth)

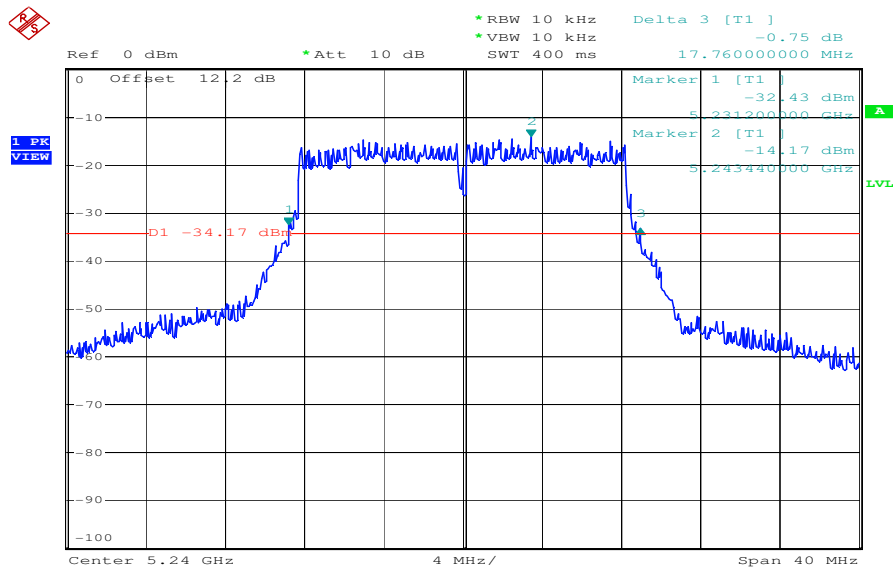

Date: 24.FEB.2011 08:18:00

Plots: OFDM / n – mode, power index 21, MCS 7, band 1

Plot 1: OFDM (lowest channel – 5180 MHz, 90% bandwidth)

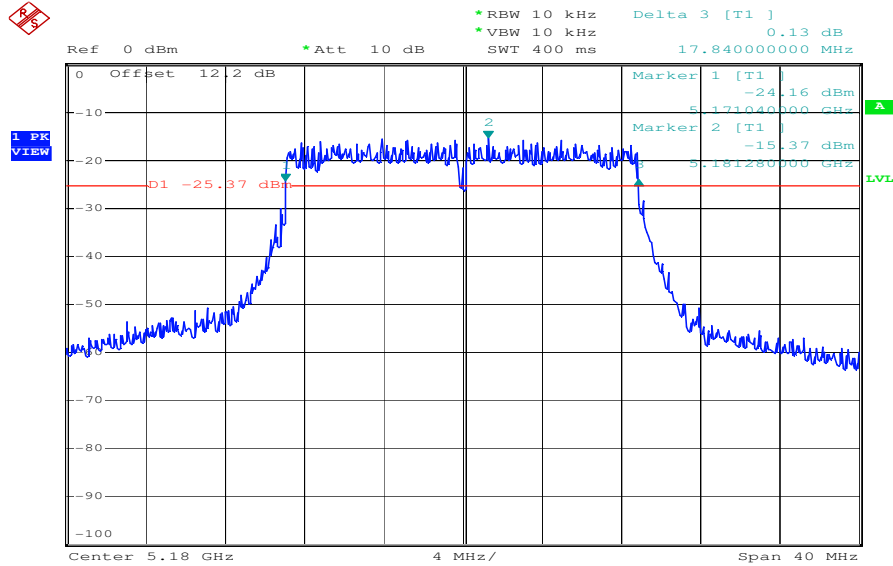

Date: 24.FEB.2011 08:00:14

Plot 2: OFDM (lowest channel – 5180 MHz, 99% bandwidth)

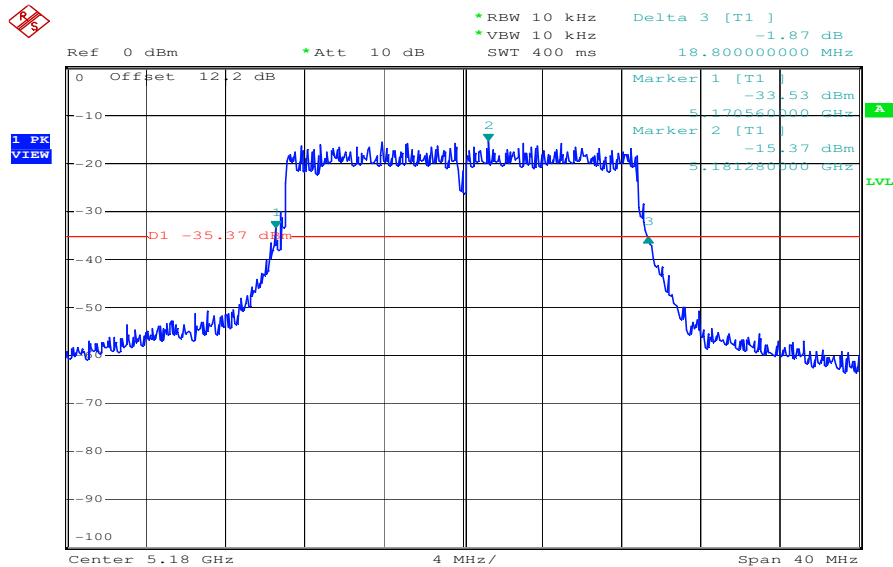

Date: 24.FEB.2011 07:59:28

Plot 3: OFDM (middle channel – 5200 MHz, 90%bandwidth)

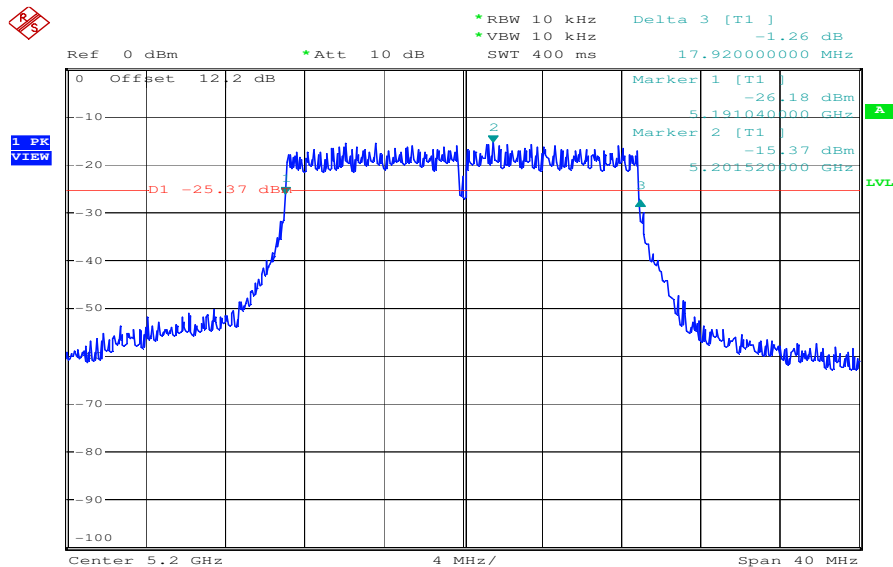

Date: 24.FEB.2011 08:07:40

Plot 4: OFDM (middle channel – 5200 MHz, 99%bandwidth)

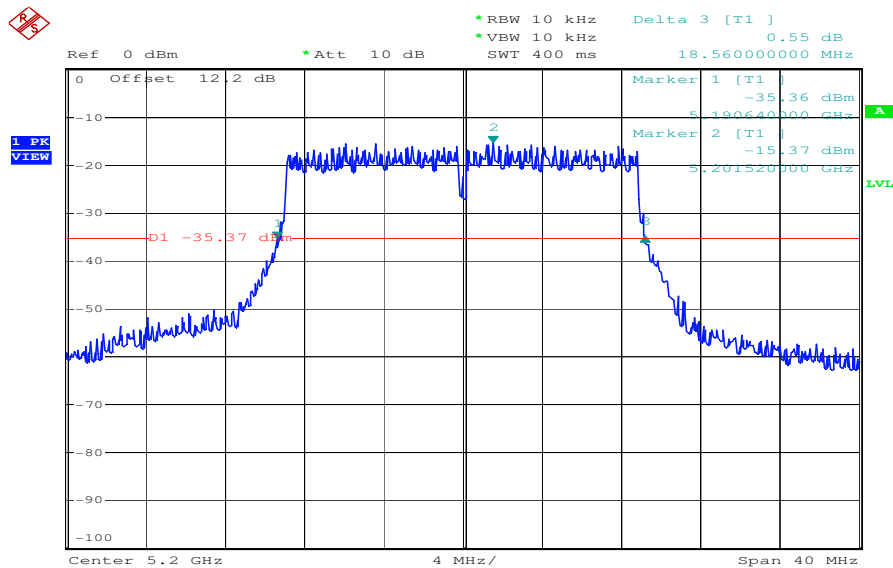

Date: 24.FEB.2011 08:07:08

Plots: OFDM / a – mode, power index 21, 54 MBit/s, band 2

Plot 1: OFDM (lowest channel – 5260 MHz, 90% bandwidth)

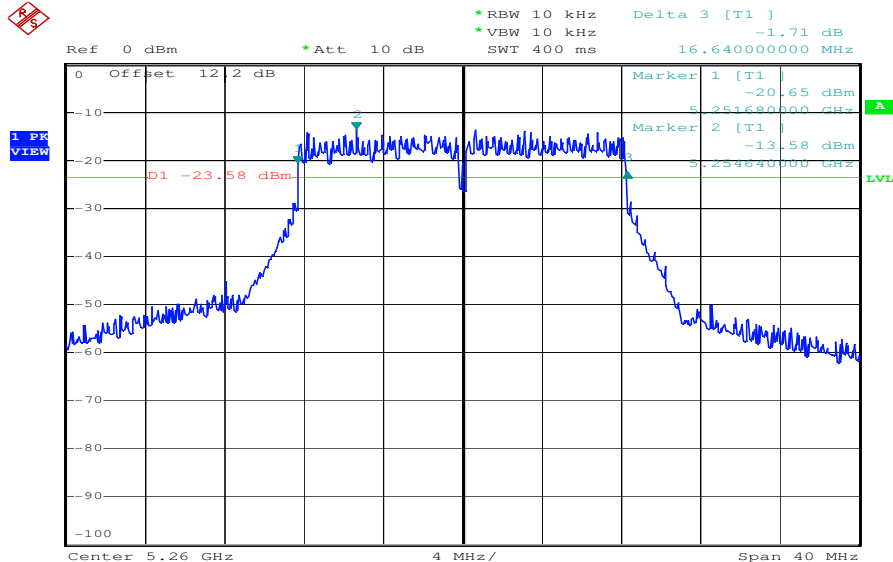

Date: 24.FEB.2011 08:21:29

Plot 2: OFDM (lowest channel – 5260 MHz, 99% bandwidth)

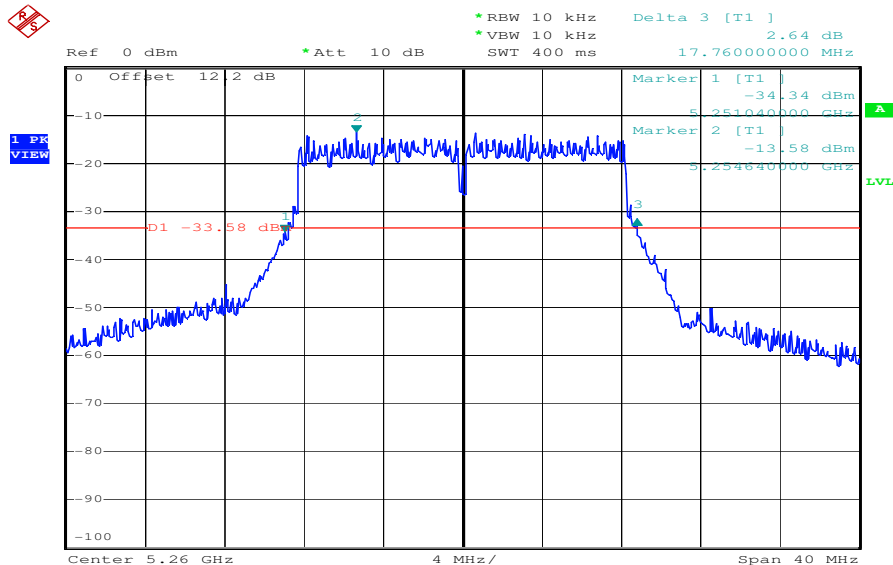

Date: 24.FEB.2011 08:21:05

Plot 3: OFDM (middle channel – 5280 MHz, 90%bandwidth)

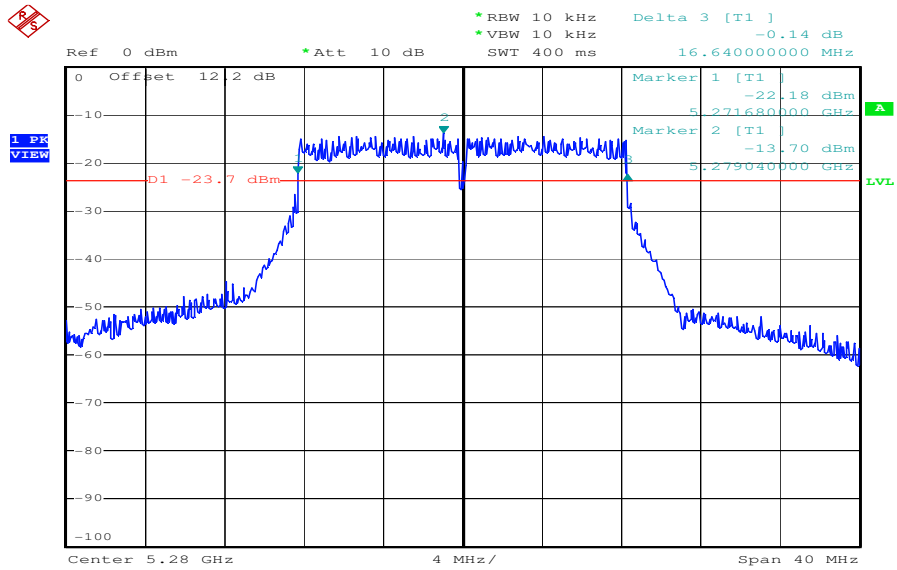

Date: 24.FEB.2011 08:25:17

Plot 4: OFDM (middle channel – 5280 MHz, 99%bandwidth)

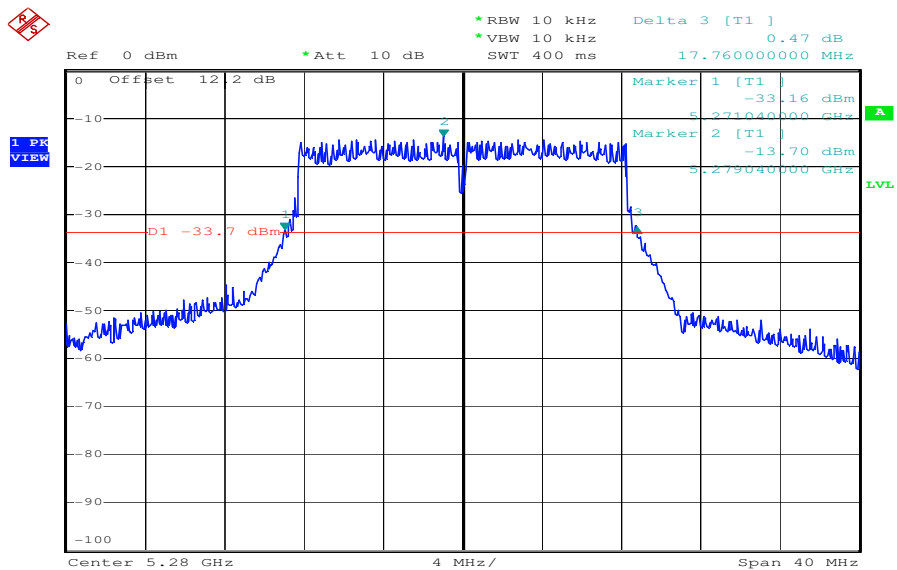

Date: 24.FEB.2011 08:24:52

Plot 5: OFDM (highest channel – 5320 MHz, 90%bandwidth)

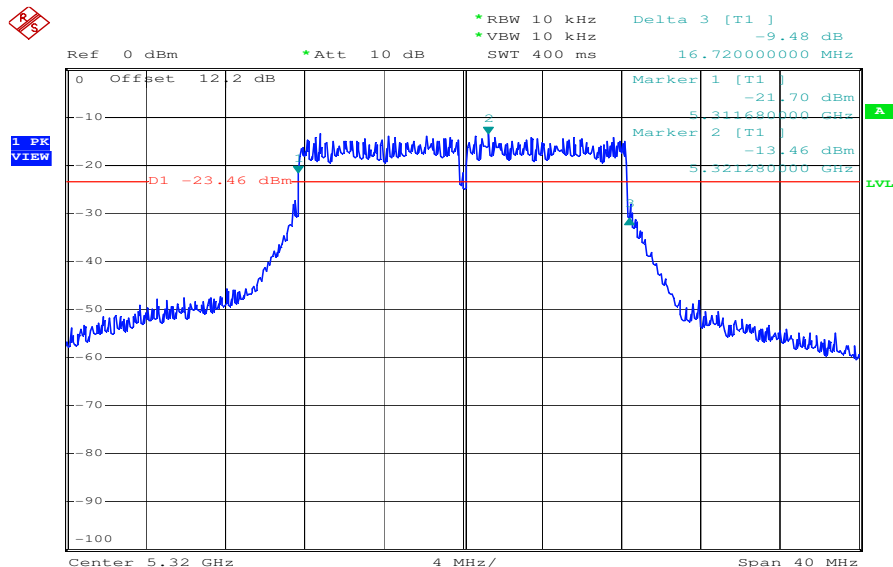

Date: 24.FEB.2011 08:29:08

Plot 6: OFDM (highest channel – 5320 MHz, 99%bandwidth)

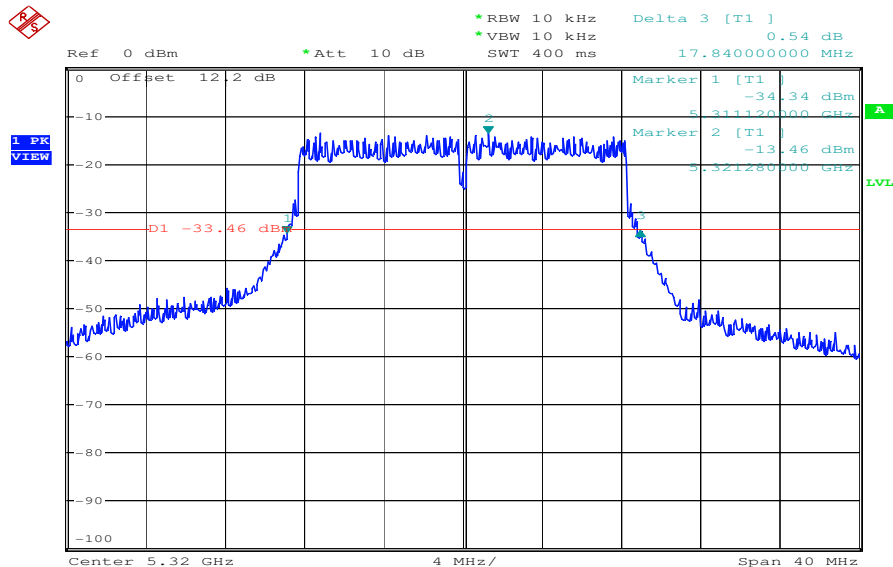

Date: 24.FEB.2011 08:29:33

Plots: OFDM / n – mode, power index 21, MCS 7, band 2

Plot 1: OFDM (lowest channel – 5260 MHz, 90% bandwidth)

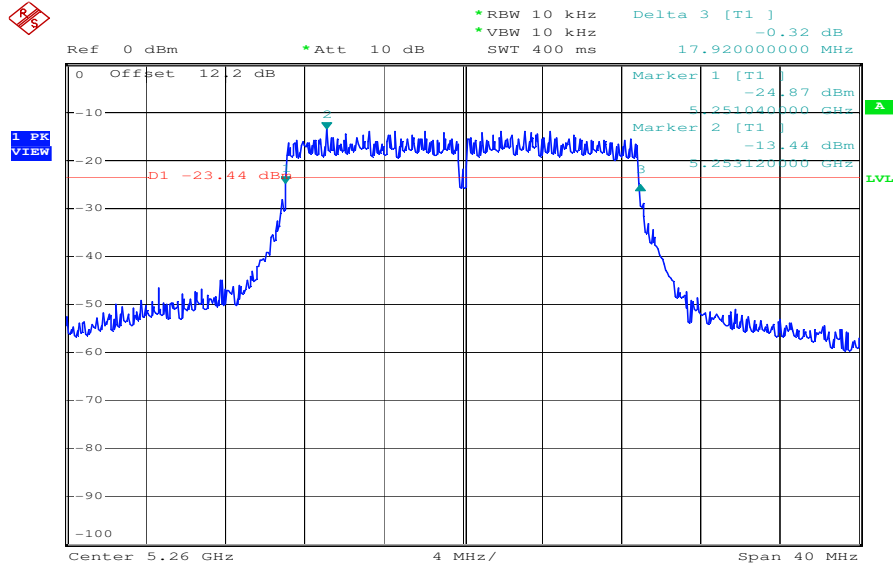

Date: 24.FEB.2011 08:23:14

Plot 2: OFDM (lowest channel – 5260 MHz, 99% bandwidth)

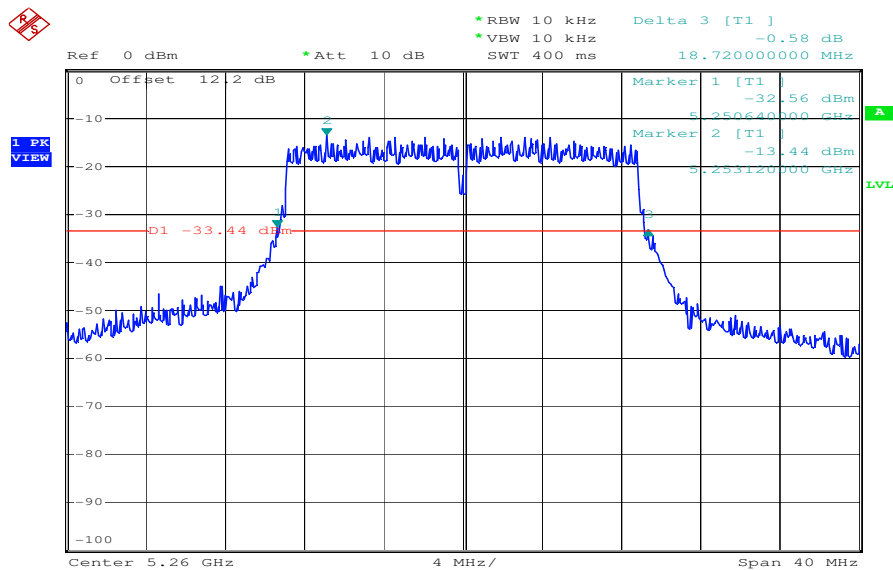

Date: 24.FEB.2011 08:22:45

Plot 3: OFDM (middle channel – 5280 MHz, 90%bandwidth)

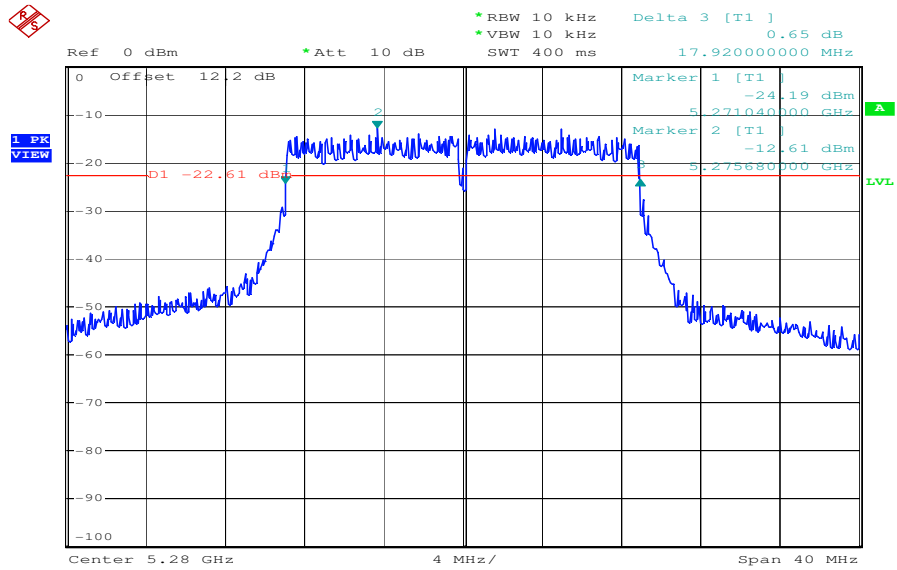

Date: 24.FEB.2011 08:27:35

Plot 4: OFDM (middle channel – 5280 MHz, 99%bandwidth)

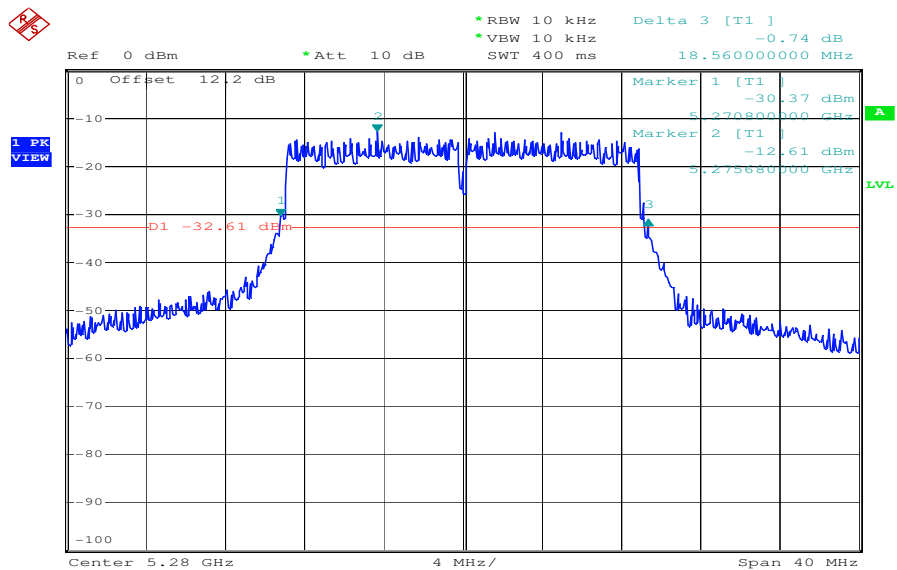

Date: 24.FEB.2011 08:27:07

Plot 5: OFDM (highest channel – 5320 MHz, 90%bandwidth)

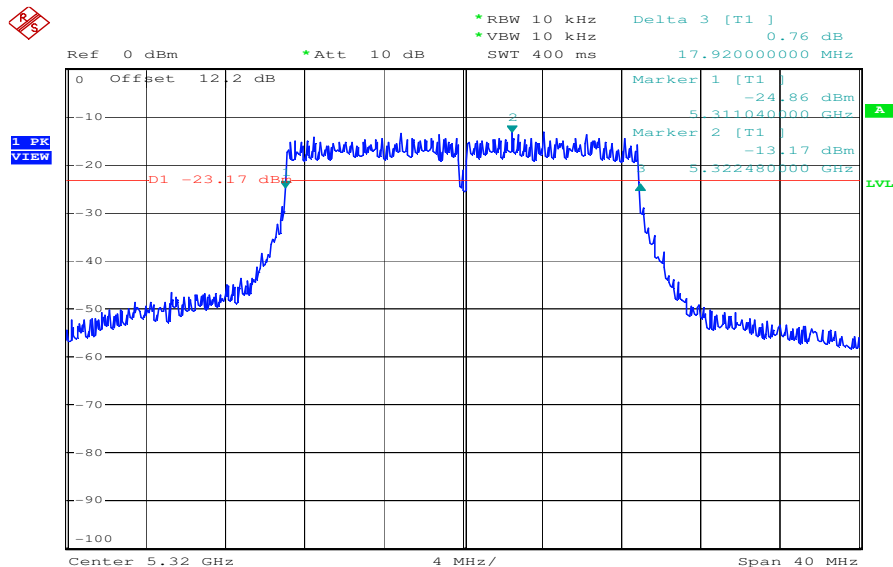

Date: 24.FEB.2011 08:31:25

Plot 6: OFDM (highest channel – 5320 MHz, 99%bandwidth)

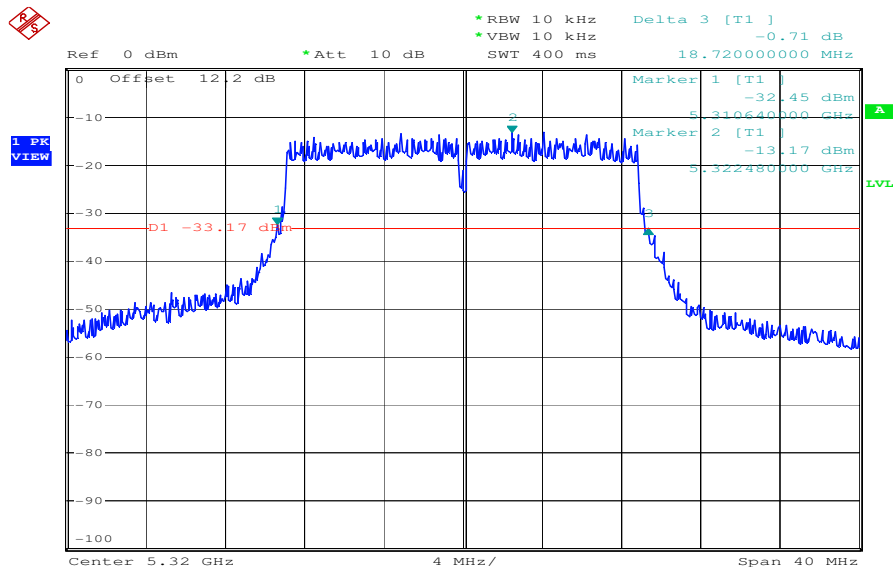

Date: 24.FEB.2011 08:30:59

9.9 Adjacent channel emitted power

Measurement parameter:

Measurement parameter	
Detector:	Peak
Sweep time:	Auto
Resolution bandwidth:	1 MHz
Video bandwidth:	1 MHz
Span:	200 MHz
Trace-Mode:	Max. hold
Additional EUT parameters:	Max. power

Limit:

Limit	
	$\geq 25 \text{ dBc; } f_0 \pm 20 \text{ MHz}$ $\geq 40 \text{ dBc; } f_0 \pm 40 \text{ MHz}$

Result: The result of the measurement is passed.

Results: OFDM a – mode, band 1 & band 2

Plot 1: 5180 MHz

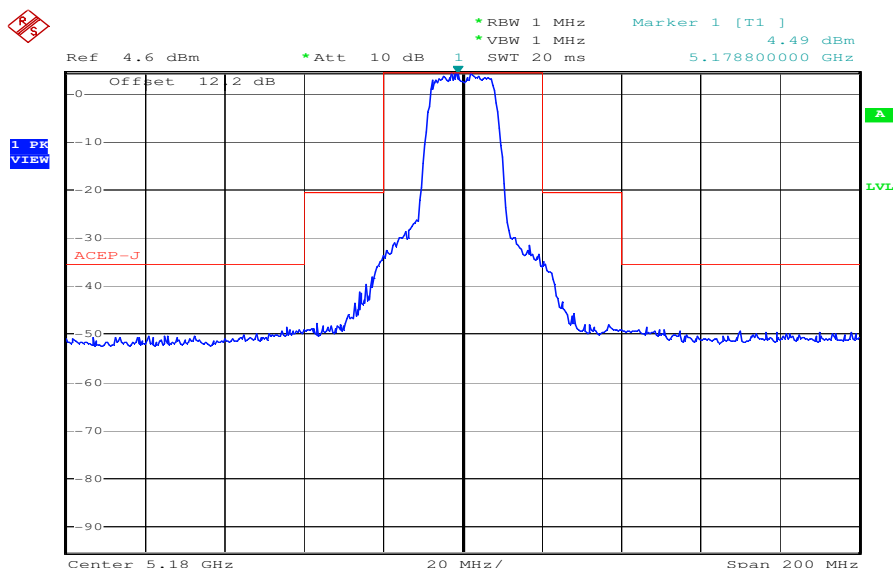

Date: 24.FEB.2011 10:46:15

Plot 2: 5200 MHz

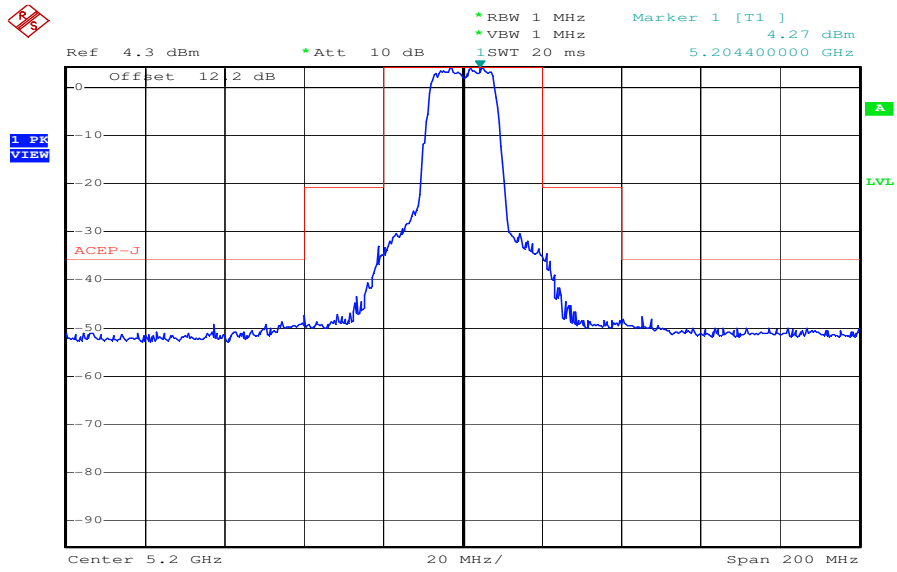

Date: 24.FEB.2011 10:49:13

Plot 3: 5240 MHz

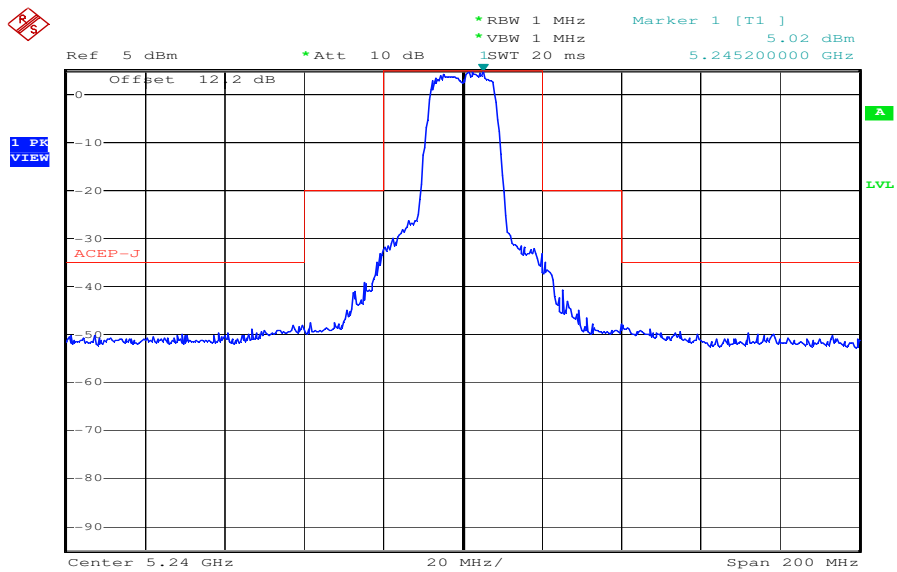

Date: 24.FEB.2011 10:51:14

Plot 4: 5260 MHz

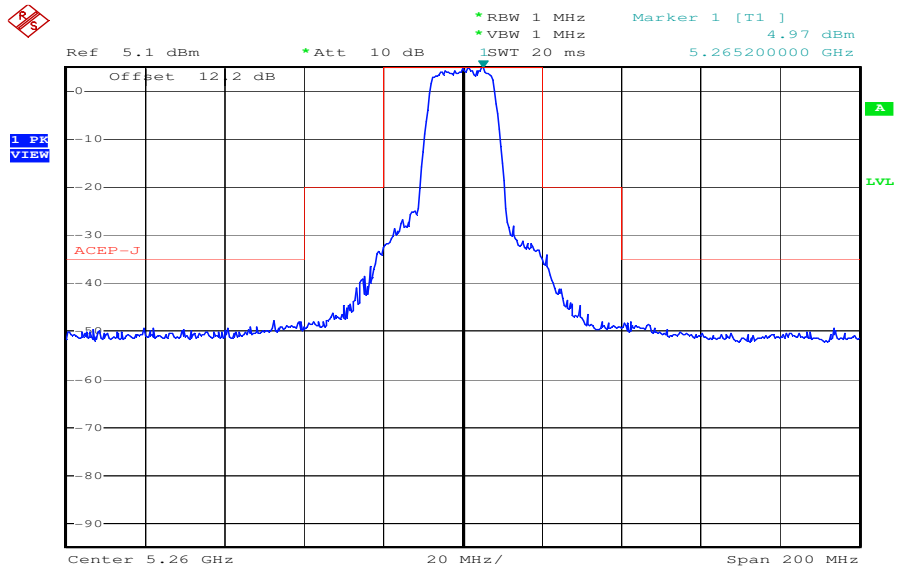

Date: 24.FEB.2011 10:53:42

Plot 5: 5280 MHz

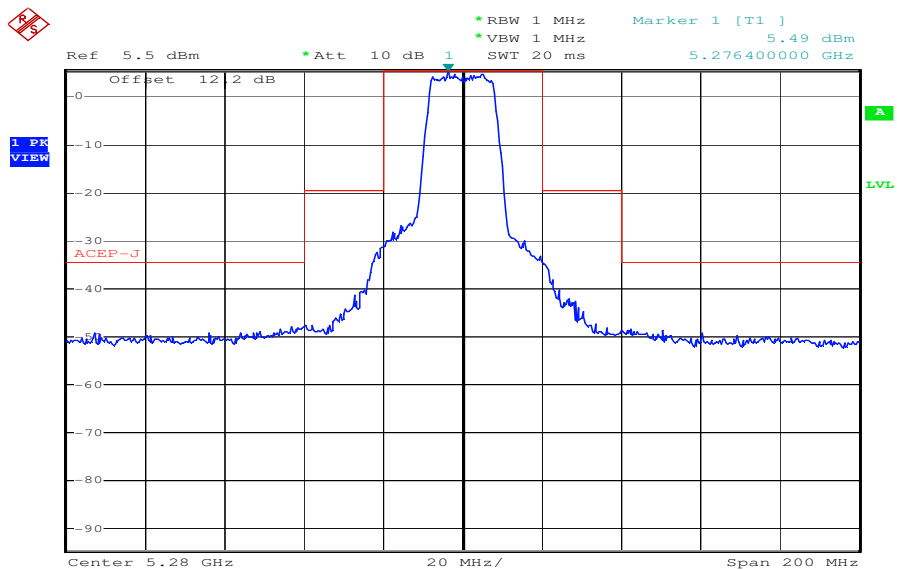

Date: 24.FEB.2011 10:56:34

Plot 6: 5320 MHz

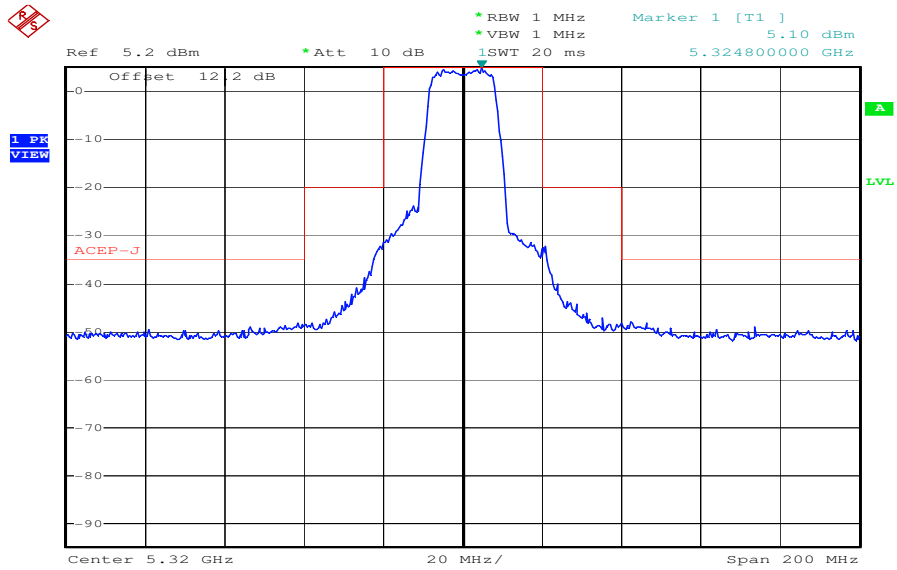

Date: 24.FEB.2011 10:58:46

Results: OFDM n – mode, band 1 & band 2

Plot 1: 5180 MHz

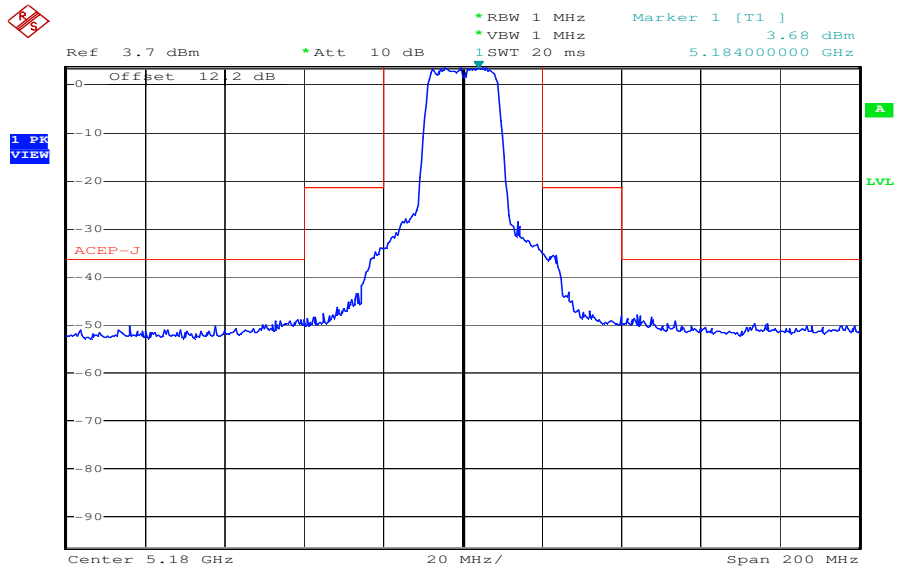

Date: 24.FEB.2011 10:47:59

Plot 2: 5200 MHz

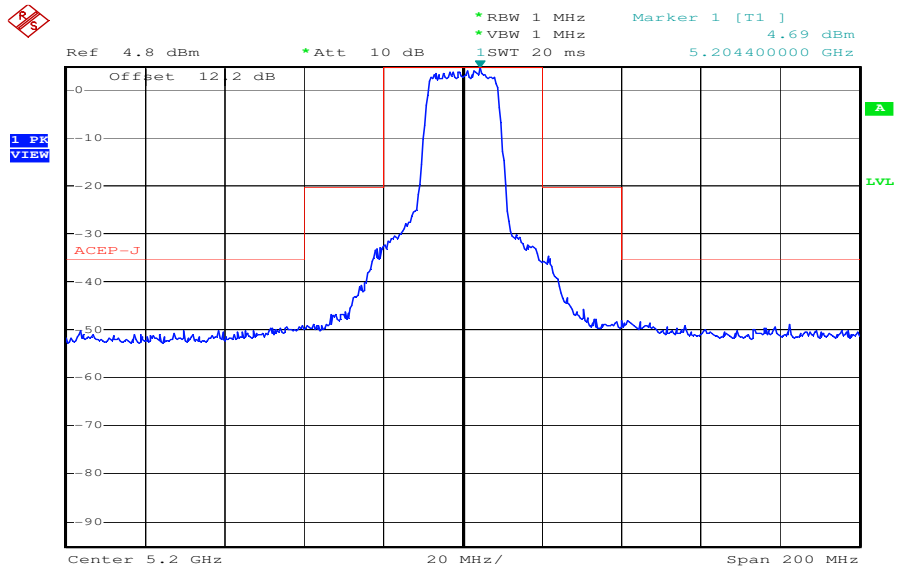

Date: 24.FEB.2011 10:50:07

Plot 3: 5240 MHz

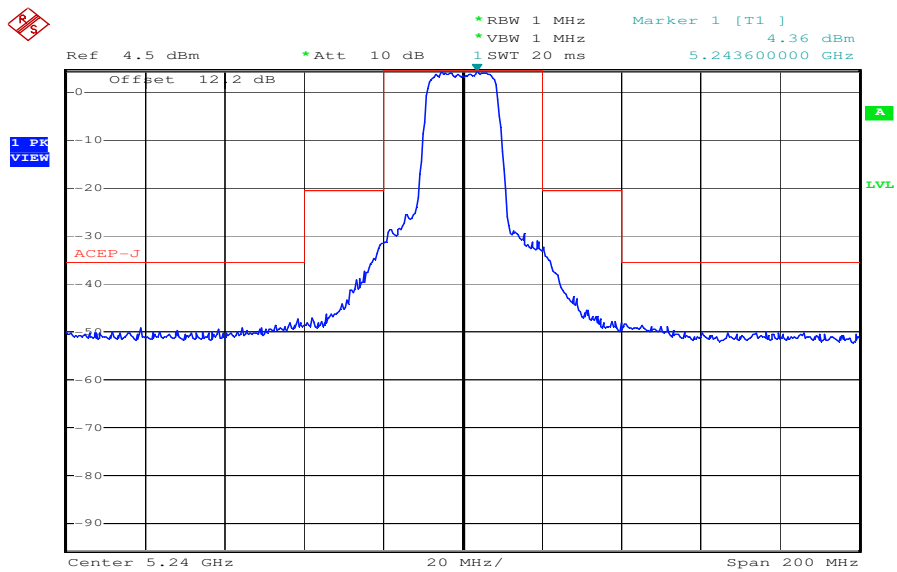

Date: 24.FEB.2011 10:52:22

Plot 4: 5260 MHz

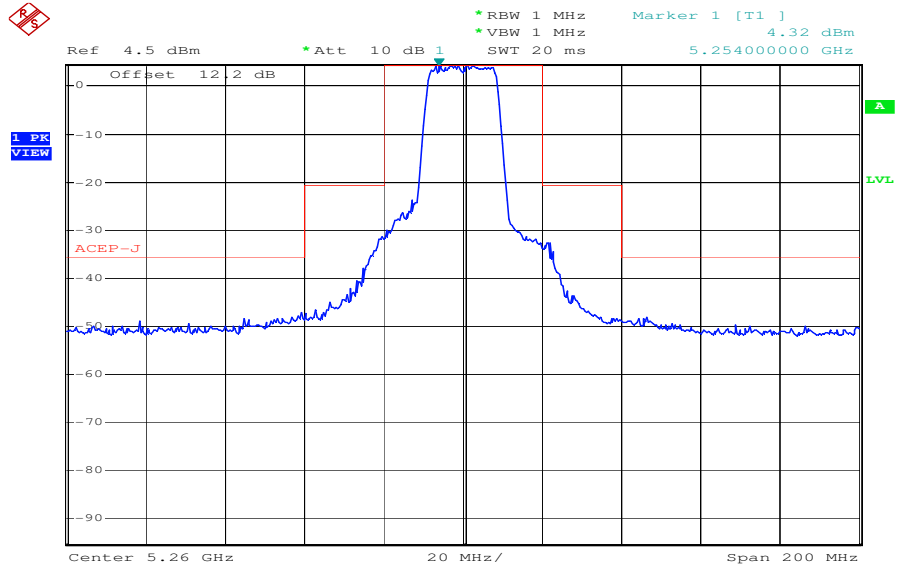

Date: 24.FEB.2011 10:54:54

Plot 5: 5280 MHz

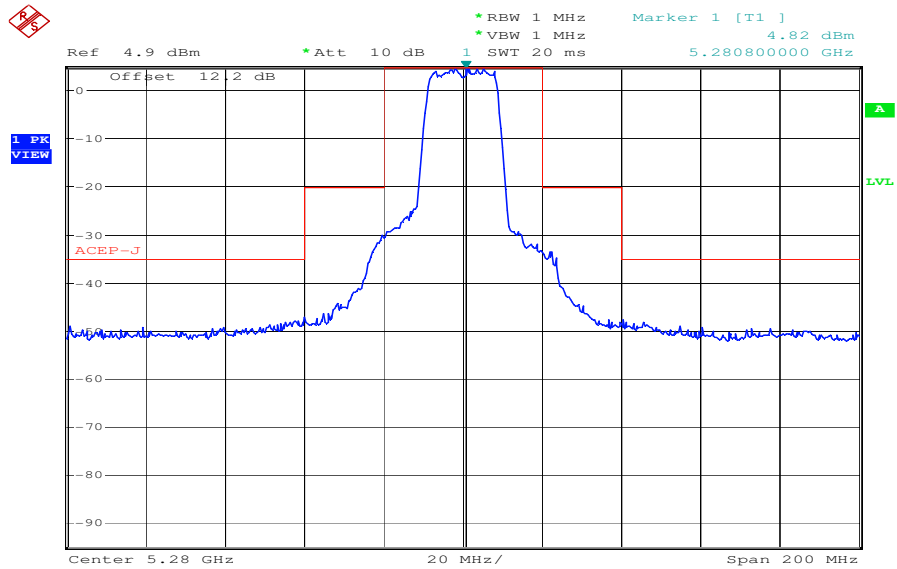

Date: 24.FEB.2011 10:57:40

Plot 6: 5320 MHz

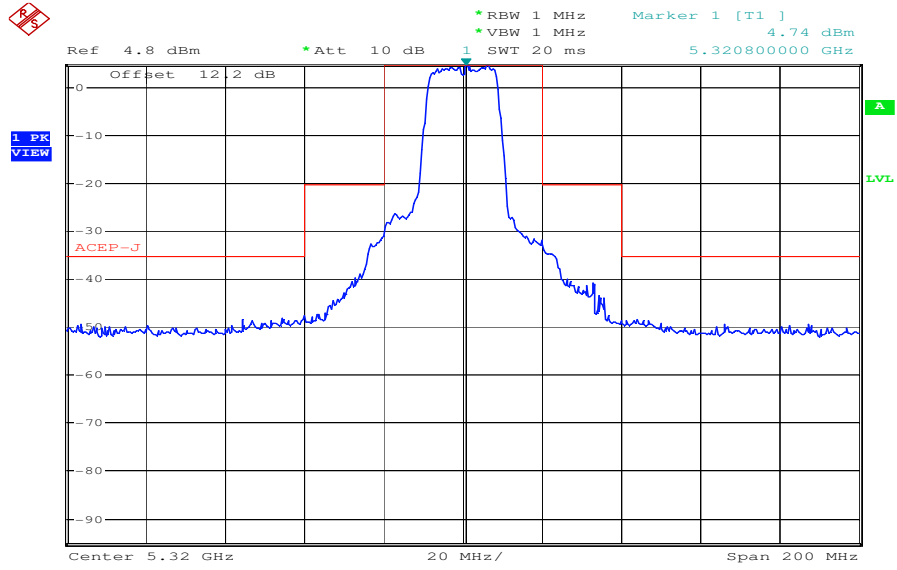

Date: 24.FEB.2011 10:59:33

9.10 Spreading factor

> 5 for devices using WLAN Standard

Result: [The result of the measurement is passed.](#)

9.11 Staying time

Not applicable – only required for hopping systems

Limit:

Limit	< 400ms
-------	---------

Result: [The result of the measurement is passed.](#)

9.12 Dwell time

Measurement parameter:

Measurement parameter	
Detector:	Positive peak
Sweep time:	2.9 ms
Resolution bandwidth:	1 MHz
Video bandwidth:	1 MHz
Span:	Zero span
Trace-Mode:	View
Additional EUT parameters:	Positive peak

Results:

Limit:

<i>Limit</i>	< 400ms
--------------	---------

Result: [The result of the measurement is passed.](#)

DC correction factor: OFDM / a – mode

Plot 1: Timing

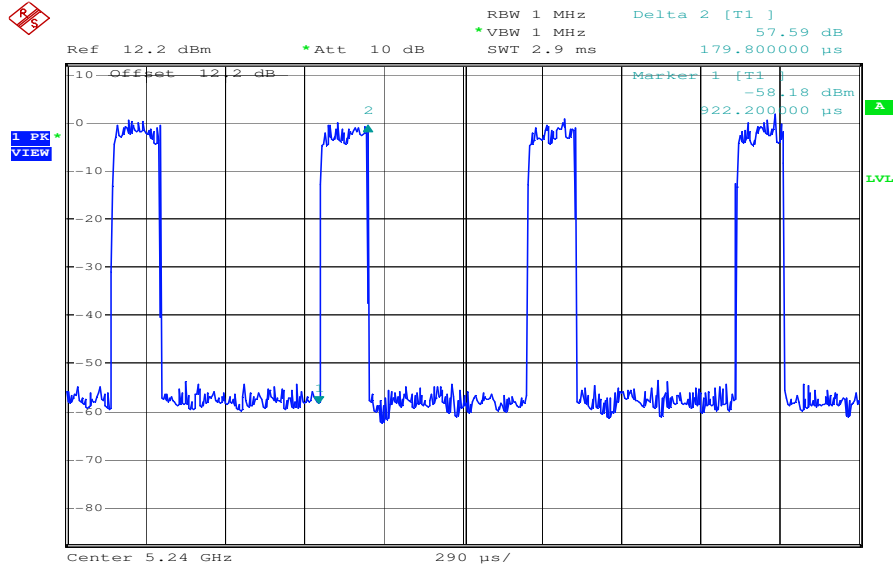

Date: 24.FEB.2011 09:59:00

Plot 2: Timing

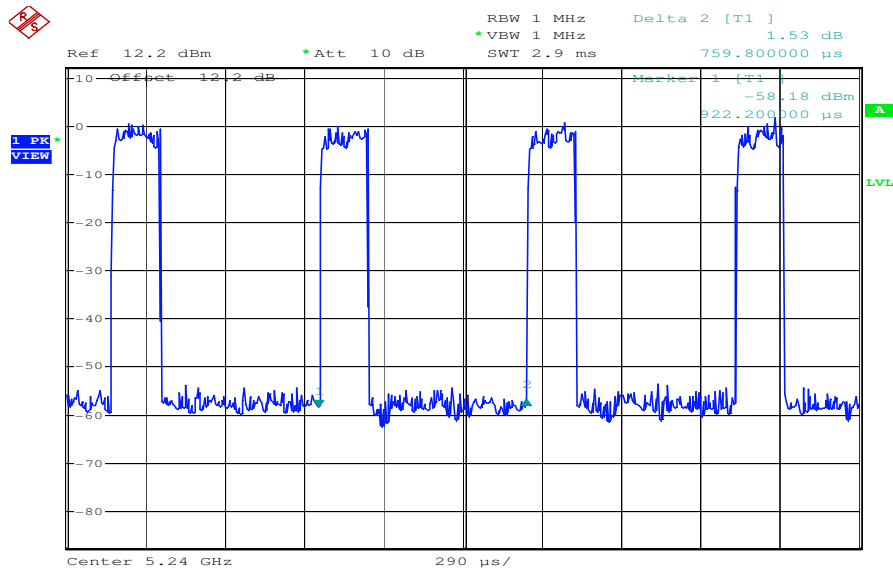

Date: 24.FEB.2011 09:59:38

DC: 23.7 %

DC correction factor: OFDM / n – mode

Plot 1: Timing

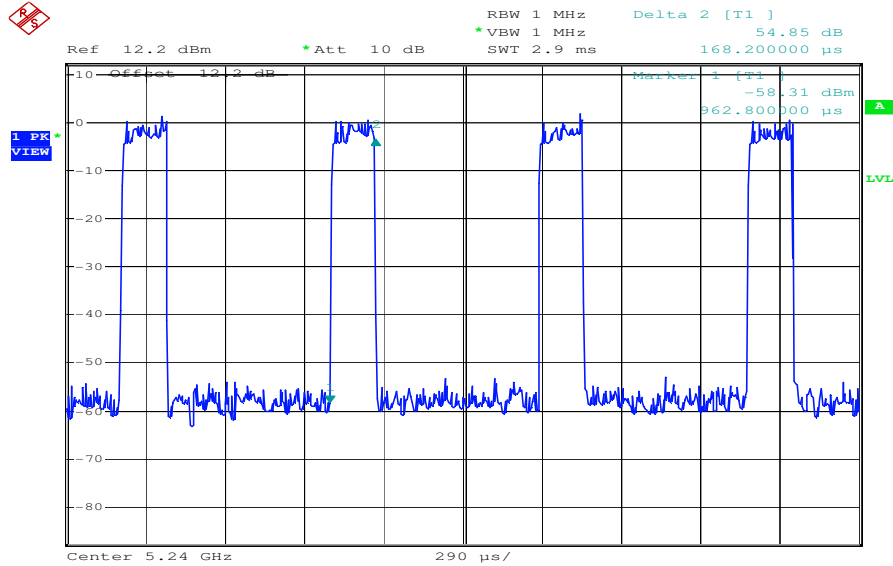

Date: 24.FEB.2011 10:00:35

Plot 2: Timing

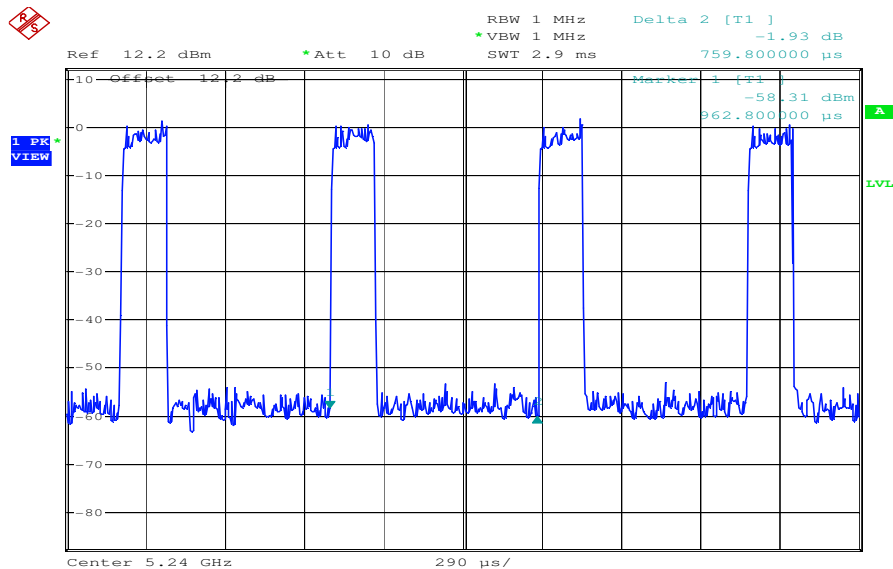

Date: 24.FEB.2011 10:00:50

DC: 22.1 %

9.13 Receiver – limit of secondarily emitted radio wave strength - conducted

Measurement parameter:

Measurement parameter	
Detector:	Peak
Sweep time:	Auto
Resolution bandwidth:	f <= 1GHz : 1 MHz f > 1GHz : 1 MHz
Video bandwidth:	f <= 1GHz : 10 kHz f > 1GHz : 10 kHz
Span:	See plots
Trace-Mode:	Max Hold
Additional EUT parameters:	Idle mode

Results:

Receiver mode	
F [MHz]	Level [dBm]
No critical peaks found (see plot)	
Found peaks:	

Limit & Verdict:

Limit	1000 MHz ≥ f : 4 nW 1000 MHz < f : 20 nW
-------	---

Result: The result of the measurement is passed.

Plots:

Plot 1: Idle / RX – mode, 9 kHz – 1 GHz

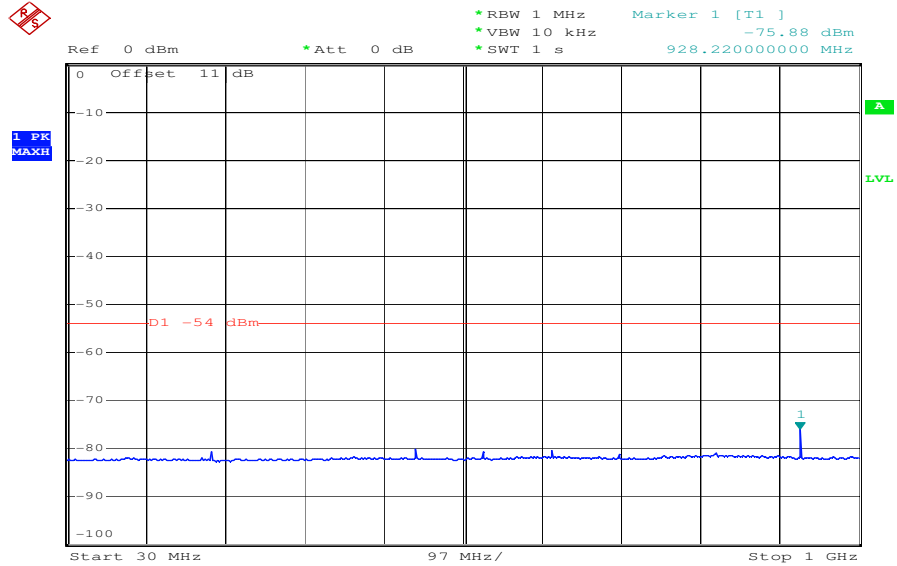

Date: 24.FEB.2011 15:31:14

Plot 2: Idle / RX – mode, 1 GHz – 12 GHz

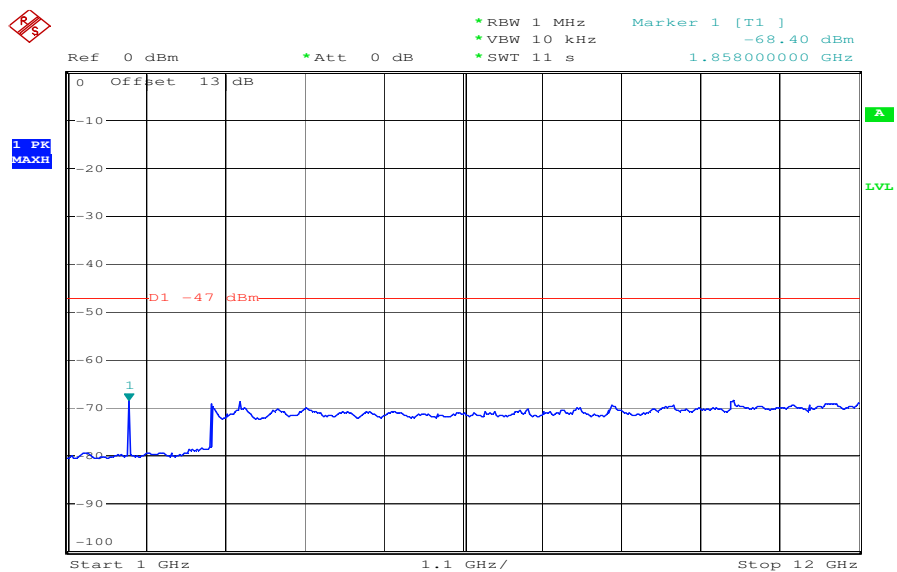

Date: 24.FEB.2011 15:33:13

Plot 3: Idle / RX – mode, 12 GHz – 26 GHz

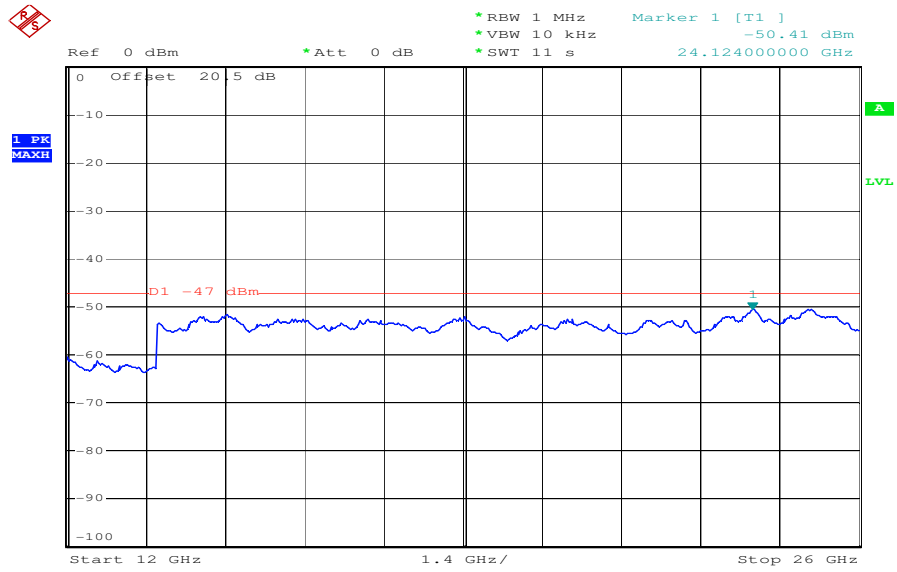

Date: 24.FEB.2011 15:34:31

9.14 Receiver – limit of secondarily emitted radio wave strength - radiated

Measurement parameter:

Measurement parameter	
Detector:	Peak
Sweep time:	Auto
Resolution bandwidth:	f <= 1GHz : 1 MHz f > 1GHz : 1 MHz
Video bandwidth:	f <= 1GHz : 1 MHz f > 1GHz : 1 MHz
Span:	100 MHz steps
Trace-Mode:	Max Hold
Additional EUT parameters:	Idle mode

Results:

Receiver mode		
F [MHz]	Level [dBm]	
Found peaks:	290.95	-59.77 (vertical) -60.94 (horizontal)
	457.19	-57.96 (vertical) -56.83 (horizontal)
	540.292	-58.63 (vertical) -58.14 (horizontal)
	For measurements above 12.75 GHz, please take a look at the plots.	

Limit & Verdict:

Limit	
	1000 MHz ≥ f : 4 nW 1000 MHz < f : 20 nW

Result: The result of the measurement is passed.

Plots:

Plot 1: Idle / RX – mode (30 MHz – 1 GHz), vertical polarization

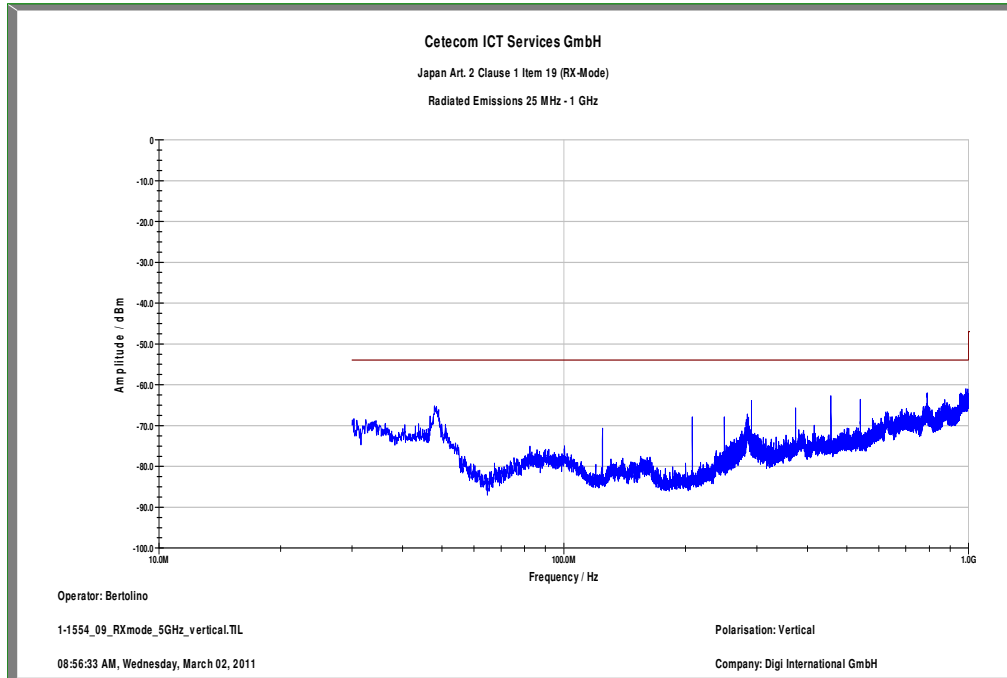

Plot 2: Idle / RX – mode (1 GHz – 12.75 GHz), vertical polarization

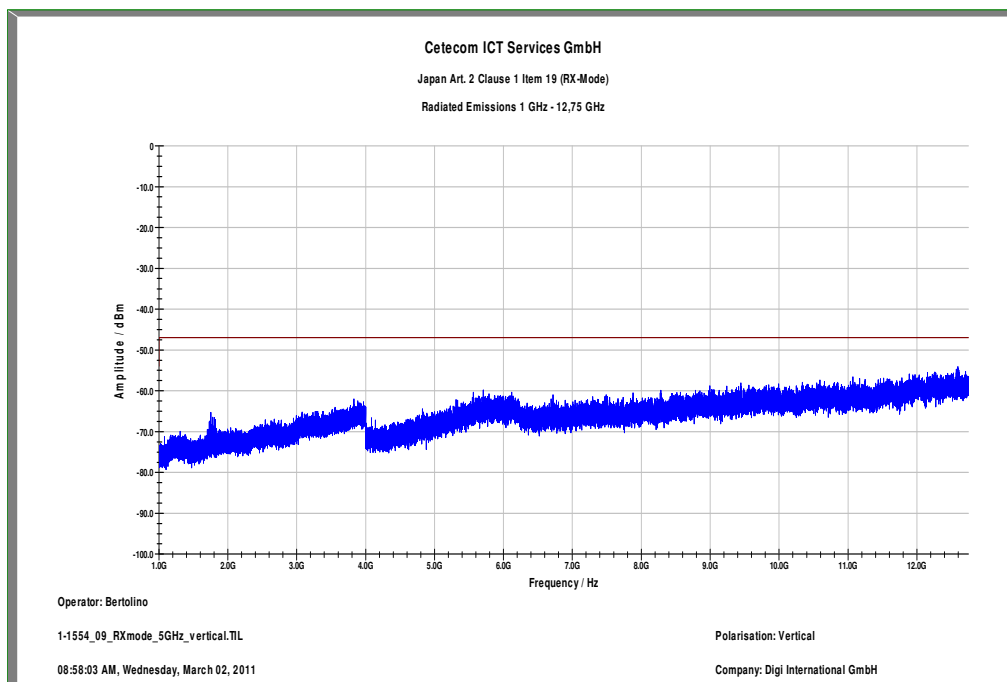

Plot 3: Idle / RX – mode (30 MHz – 1 GHz), horizontal polarization

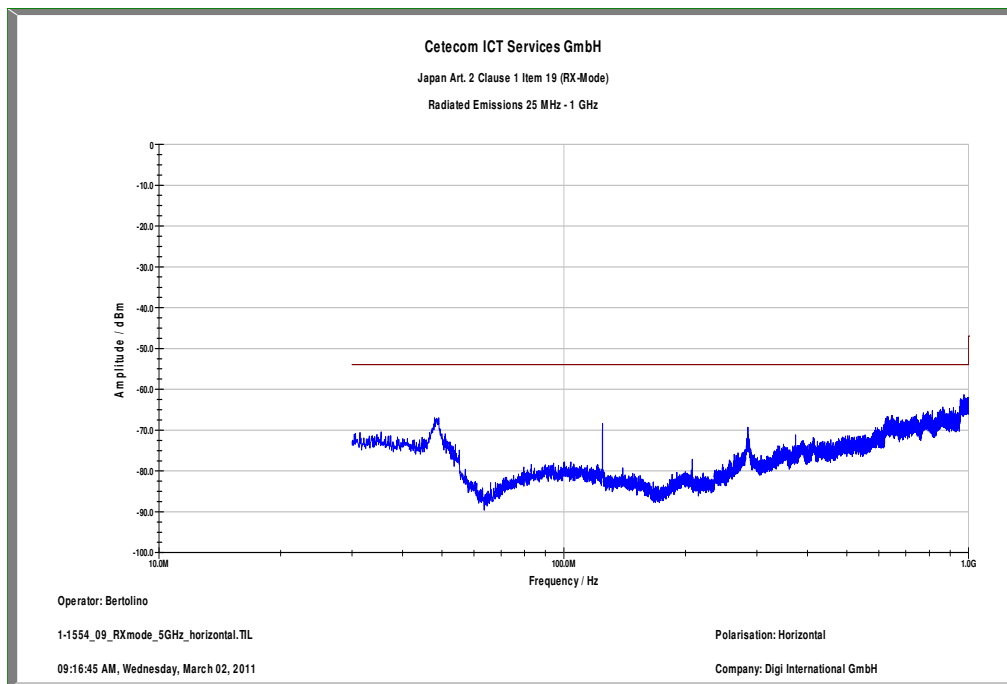

Plot 4: Idle / RX – mode (1 GHz – 12.75 GHz), horizontal polarization

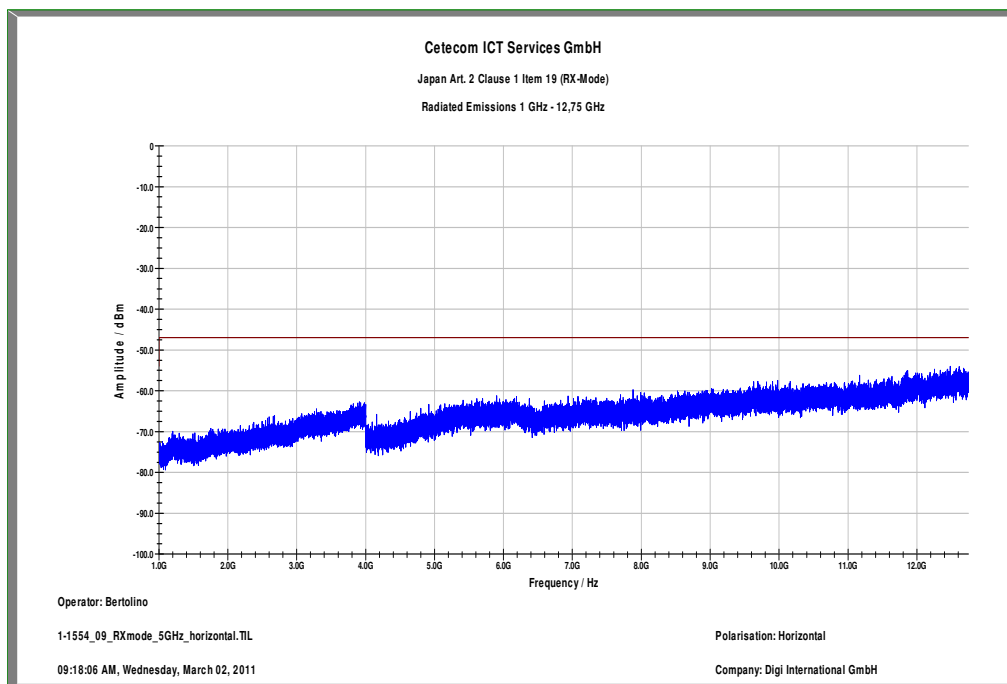

9.15 Interference prevention function

Interference Prevention Function:

(Article 9.4): Via Identification Code unexpected login incidences to extraneous receivers are avoided

Result: The result of the measurement is passed.

9.16 Carrier sensing function

Carrier sensing function:

The sample does not transmit or stop transmission when detecting an interferer in the same transmitting channel.

Result: The result of the measurement is passed.

9.17 Enclosure requirements

Not applicable! The EUT is a WLAN module without housing!

Result: -/-

10 Test equipment and ancillaries used for tests

Typically, the calibrations of the test apparatus are commissioned to and performed by an accredited calibration laboratory. The calibration intervals are determined in accordance with the DIN EN ISO/IEC 17025. In addition to the external calibrations, the laboratory executes comparison measurements with other calibrated test systems or effective verifications. Weekly chamber inspections and range calibrations are performed. Where possible, rf-generating and signalling equipment as well as measuring receivers and analyzers are connected to an external high-precision 10 MHz reference (GPS-based or rubidium frequency standard).

In order to simplify the identification of the equipment used at some special tests, some items of test equipment and ancillaries can be provided with an identifier or number in the equipment list below (Labor/Item).

No.	Lab / Item	Equipment	Type	Manufact.	Serial No.	INV. No Cetecom	Kind of Calibration	Last Calibration	Next Calibration
1	n. a.	Double-Ridged Waveguide Horn Antenna 1-18.0GHz	3115	EMCO	8812-3088	300001032	viKI!	05.03.2009	05.03.2011
2	n. a.	Anechoic chamber	FAC 3/5m	MWB / TDK	87400/02	300000996		23.03.2009	
3	n. a.	Relais Matrix	PSU	R&S	890167/024	300001168	ne		
4	n. a.	Amplifier	00502650- 28-5a	Parzich GMBH	928979	300003143	ne		
5	n. a.	TILE-Software Emission	Quantum Change, Modell TILE- ICS/FULL	EMCO	none	300003451	ne		
6	n. a.	PSA Spectrum Analyzer 3 Hz - 26.5 GHz	E4440A	Agilent Technologies	MY48250080	300003812	k	08.09.2010	08.09.2012
7	n. a.	RF Filter Section 9kHz - 1GHz	N9039A	Agilent Technologies	MY48260003	300003825	viKI!	08.09.2010	08.09.2012
8	n. a.	Broadband Test-Antenna 30 MHz - 3 GHz	VULB9163	Schwarzbeck	371	300003854	viKI!	17.12.2008	17.12.2011
9	11b	Microwave System Amplifier, 0.5- 26.5 GHz; 25 dB gain	83017A	HP Meßtechnik	3123A00105	300002268	ev		
10	A026	Std. Gain Horn Antenna 12.4 to 18.0 GHz	639	Narda		300000787	ne		
11	A029	Std. Gain Horn Antenna 18.0 to 26.5 GHz	638	Narda		300002442	ne		
12	n. a.	Temperature Test Chamber	VT 4002	Heraeus Voetsch	521/83761	300002326	Ve	28.05.2009	28.05.2011
13	n. a.	Spectrum Analyzer 20 Hz - 50 GHz	FSU50	R&S	200012	300003443	ve	01.07.2010	01.07.2012
14	n. a.	Spectrum Analyzer 9kHz to 30GHz - 140..+30dBm	FSP30	R&S	100886	300003575	k	07.09.2010	07.09.2012
15	n. a.	Isolating Transformer	RT5A	Grundig	8041	300001626	g		
16	n. a.	Splitter	15542	Mini Circuits	15542	400000086	ev		
17	n. a.	Splinter	42000	Anaren	4730	400000085	ev		
18	n. a.	Switch Unit	TS-RSP	R&S	100155	300003281	ev		
19	n. a.	Hygro- Thermometer	-/, 5-45 °C, 20-100%rF	Thies Clima	-/	400000089	k	04.05.2010	04.05.2011
20	n. a.	CTIA-Chamber	Chamber AMS 8500	ETS-Lindgren Finnland		300003327- 0000	ne		
21	n. a.	Limiting Amplifier (Microwave Amplifier) Spectrum	LA 02-801	JCA Technology	101	300003341	ne		
22	n. a.	Analyzer 9kHz - 30 GHz	FSP30	R&S	100623	300003464	Ve	25.06.2010	25.06.2012
23	n. a.	Optionen für	SMU-B11 +	R&S	101222 +	300003960	ne		

		SMU200	SMU-K44 + SMU-K65		100438 + 100078		
24	n. a.	Software Lizenz Paket AMS-32 + Option für OTA Messsoftw	AMS32- VUS + AMS32- K28	R&S	101425 + 101424	300003959	ne
25	n. a.	Option für CMU200 Offene Schalt- und	CMU-K90	R&S	101325	300003958	ne
26	n. a.	Steuerplattform für Testsystem Autom	OSP120	R&S	100083	300003957	ne

Agenda: Kind of Calibration

k	calibration / calibrated	EK	limited calibration
ne	not required (k, ev, izw, zw not required)	zw	cyclical maintenance (external cyclical maintenance)
ev	periodic self verification	izw	internal cyclical maintenance
Ve	long-term stability recognized	g	blocked for accredited testing
vlk!	Attention: extended calibration interval		
NK!	Attention: not calibrated	*)	next calibration ordered / currently in progress

Annex A Photographs of the test setup

Photo documentation:

Photo 1: chamber C



Photo 2: chamber C

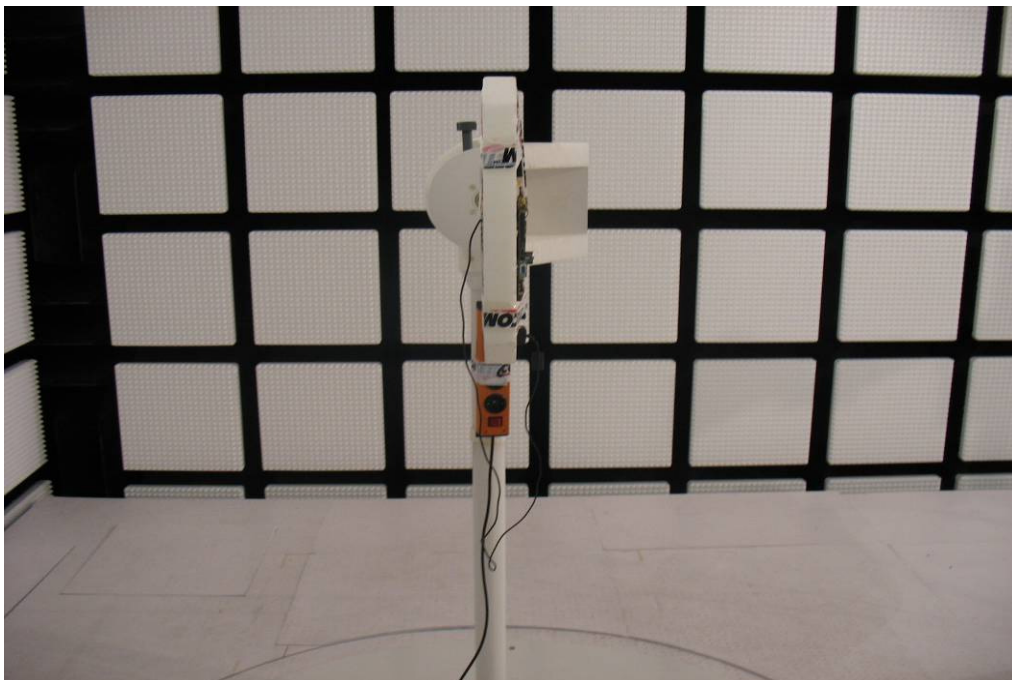

Photo 3: chamber C

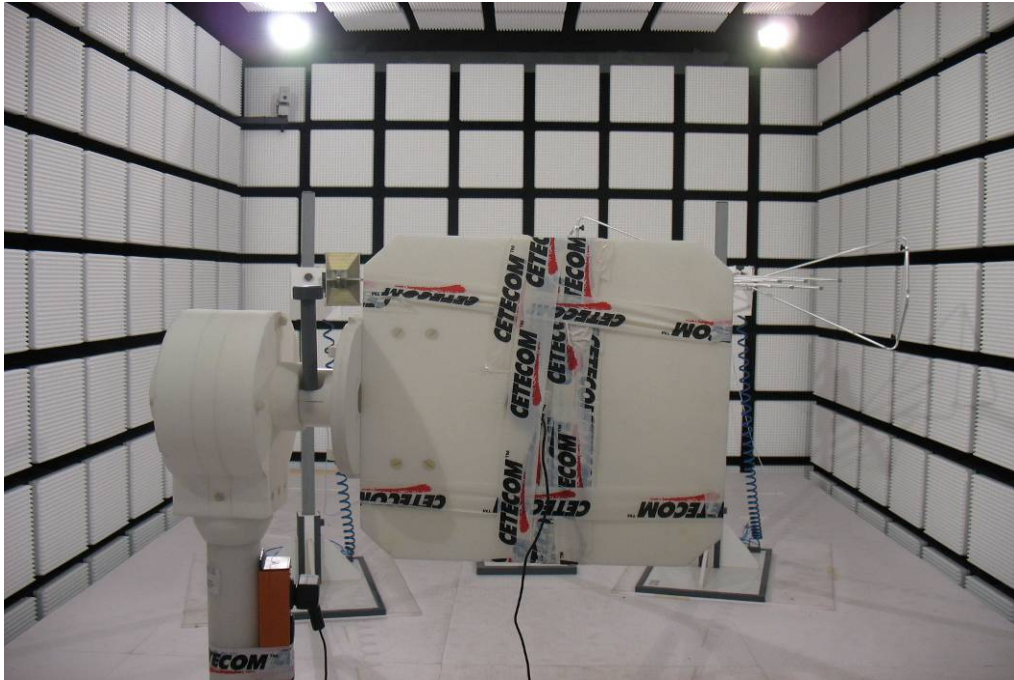

Photo 4: chamber C

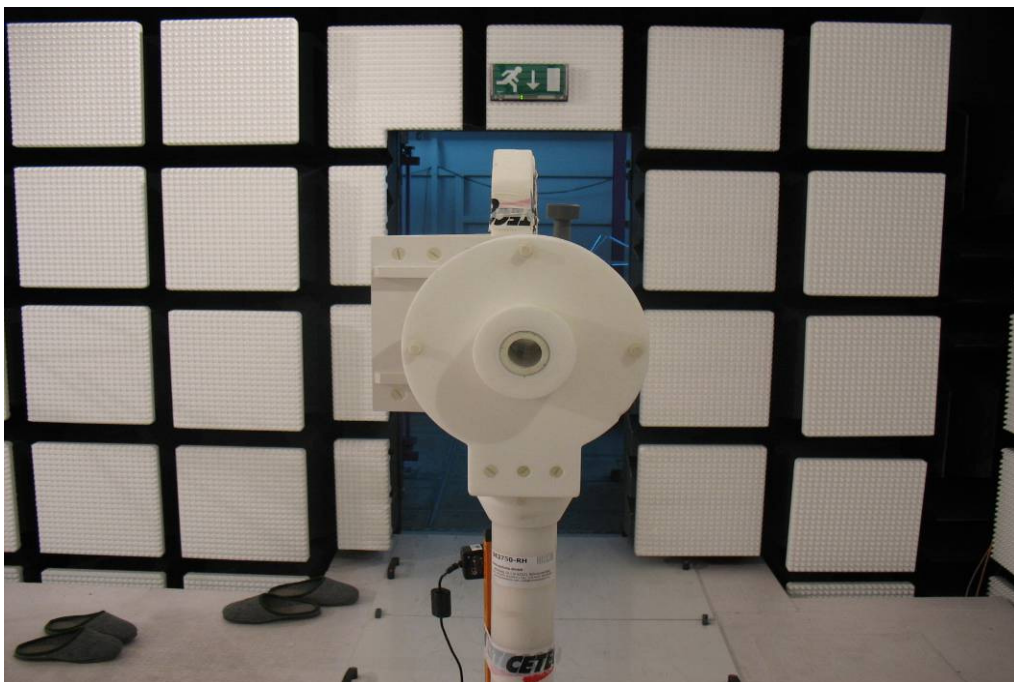

Photo 5: chamber C

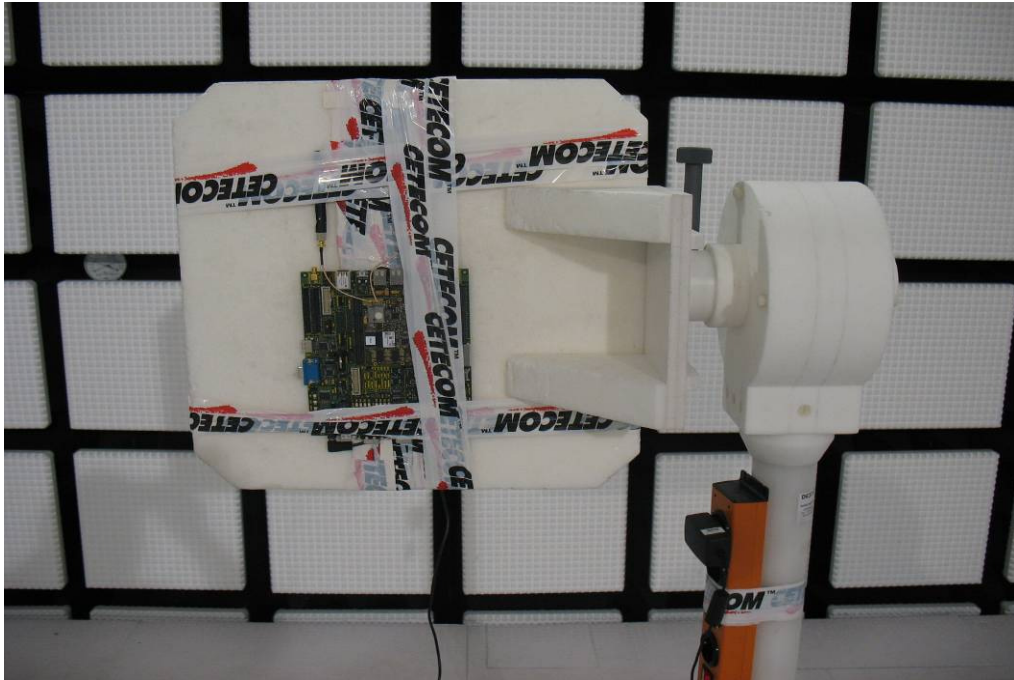

Photo 6: chamber C



Photo 7: chamber C

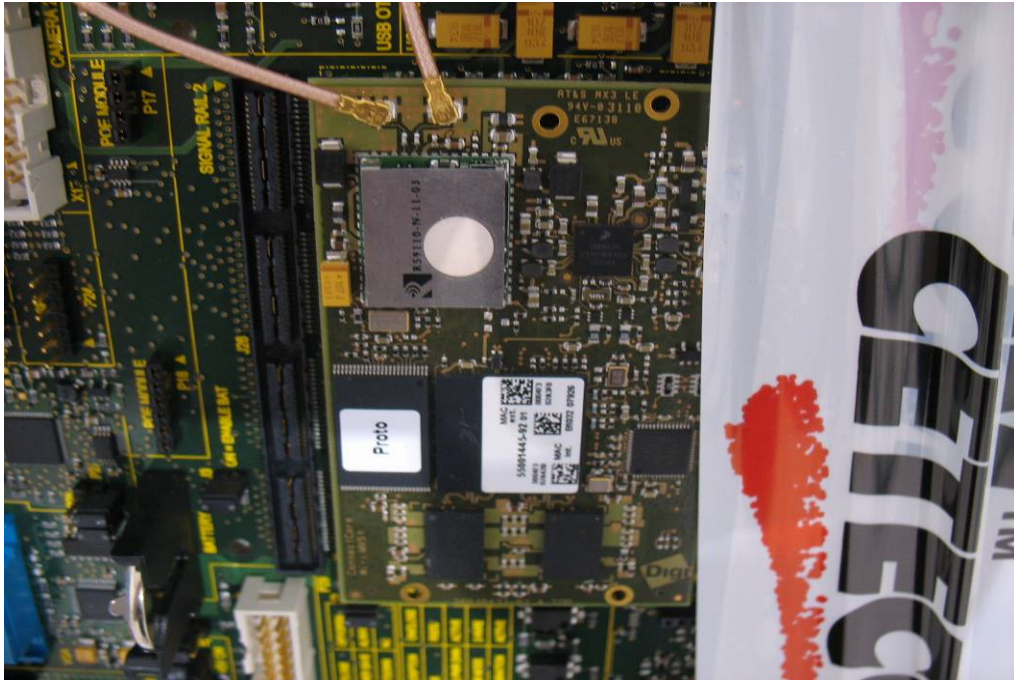

Photo 8: OTA chamber

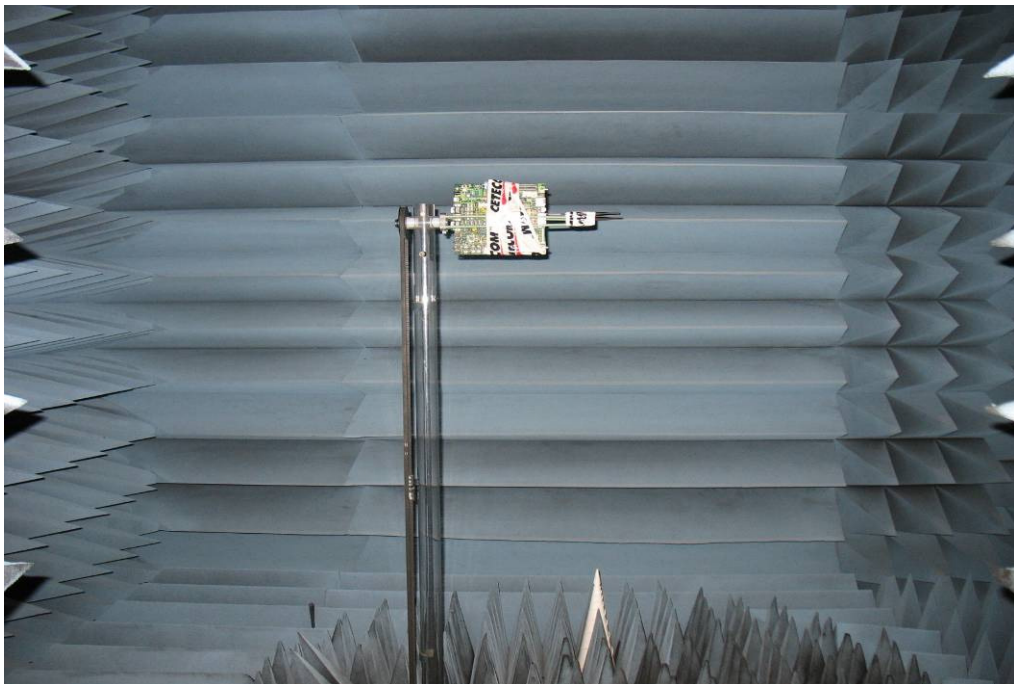

Photo 9: OTA chamber

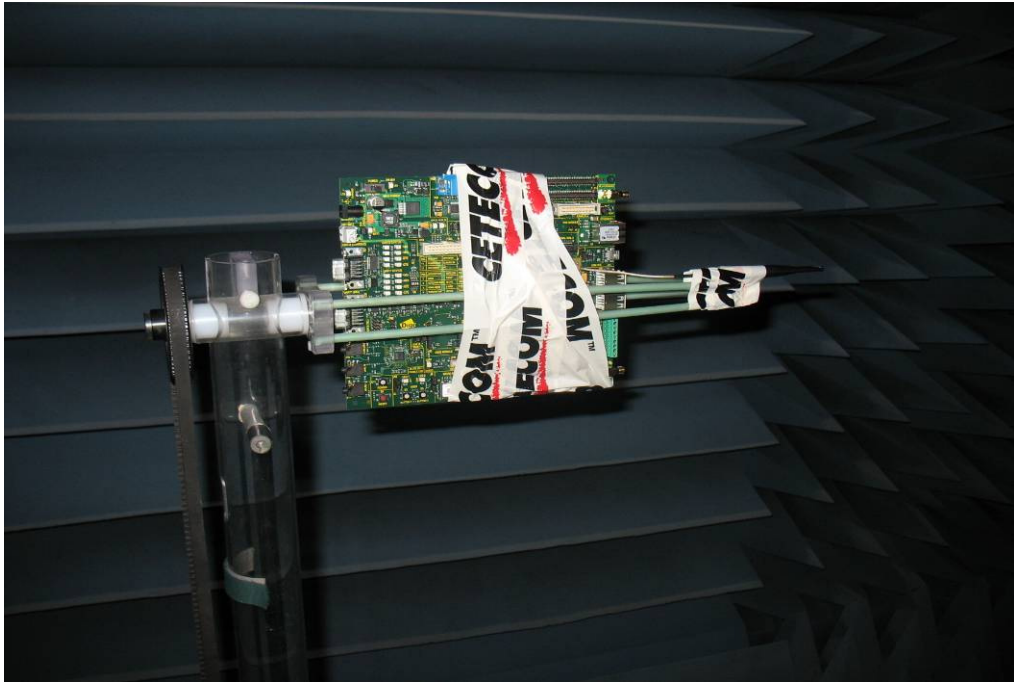
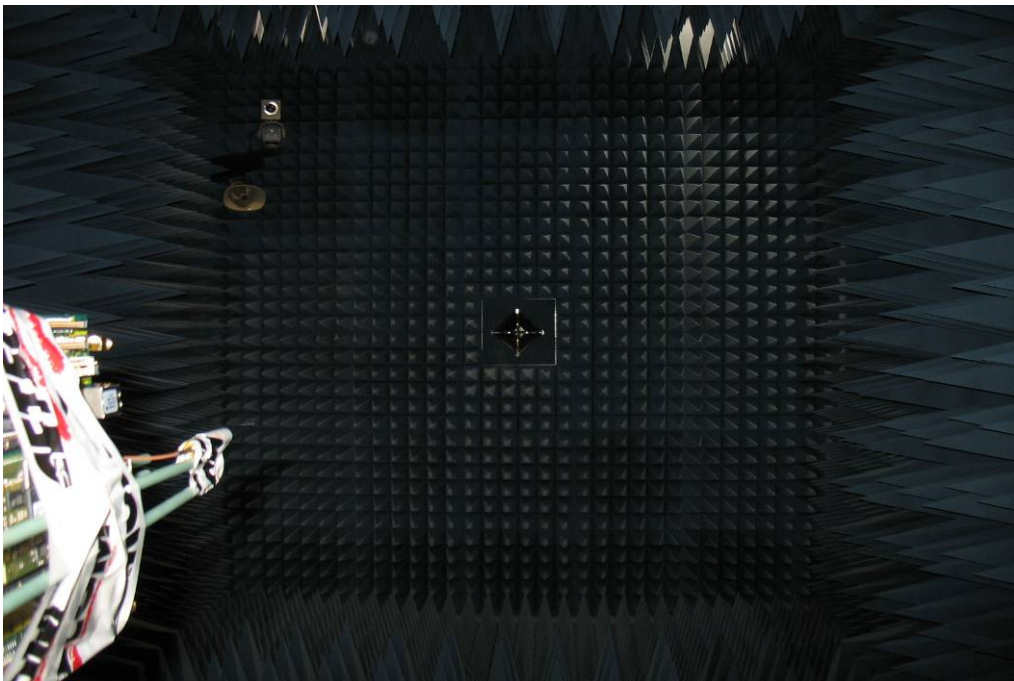

Photo 10: OTA chamber



Annex B External photographs of the EUT

Photo documentation:

Photo 1: evaluation board with WLAN module

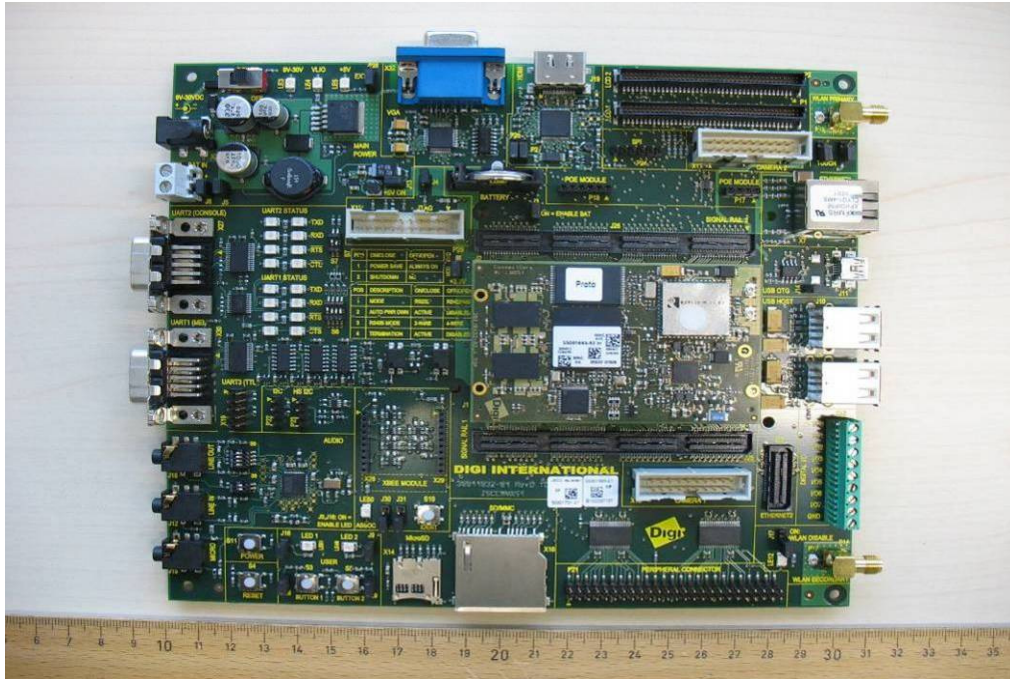

Photo 2: evaluation board with WLAN module

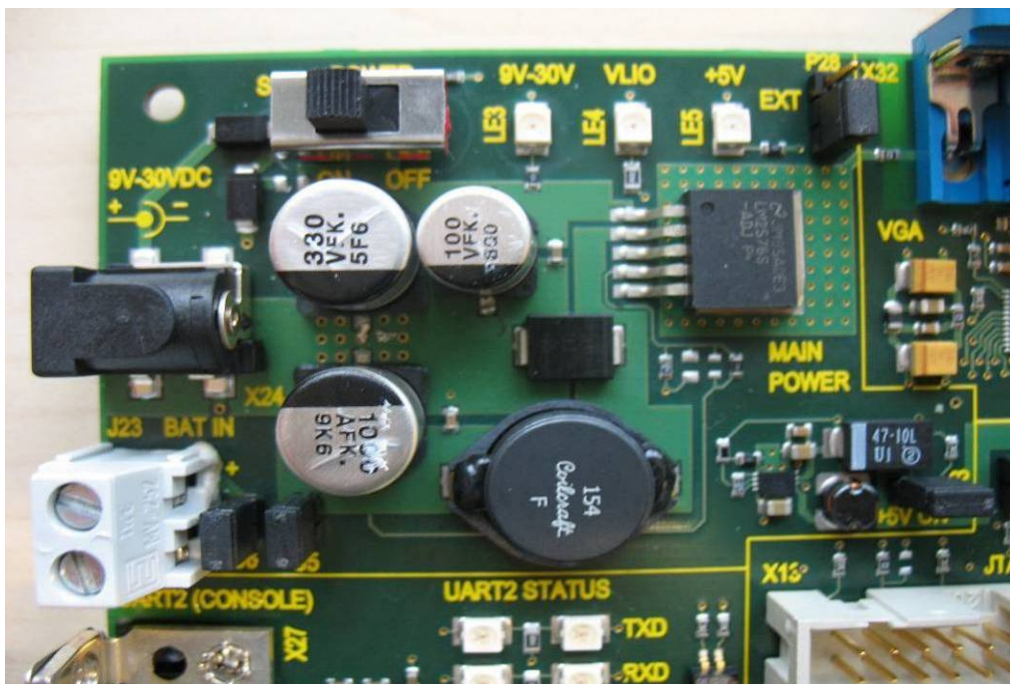

Photo 3: evaluation board with WLAN module

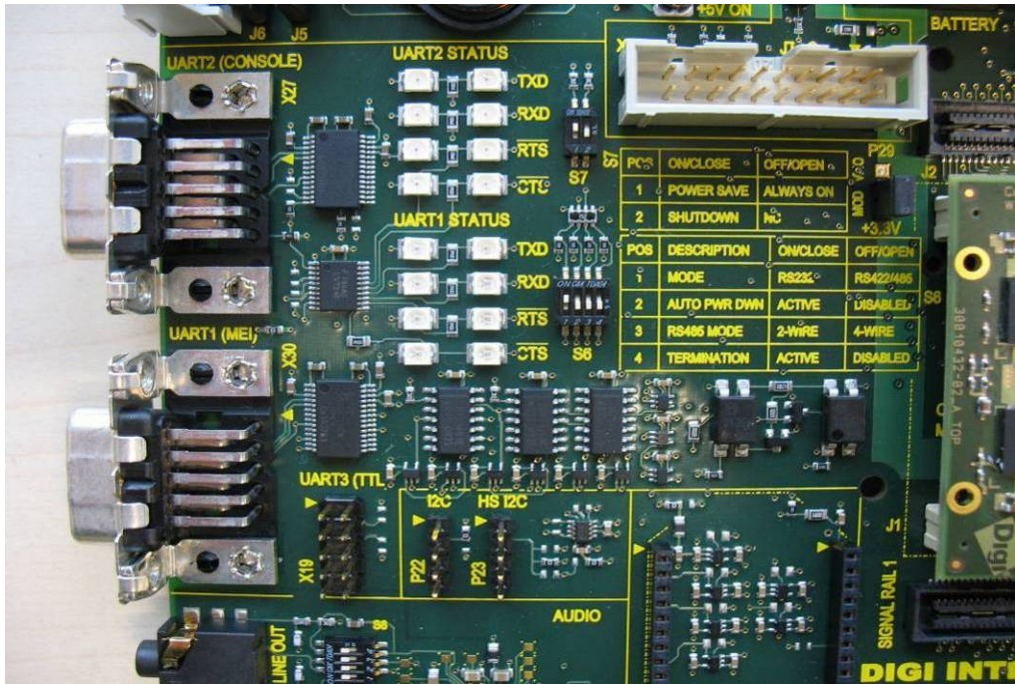

Photo 4: evaluation board with WLAN module

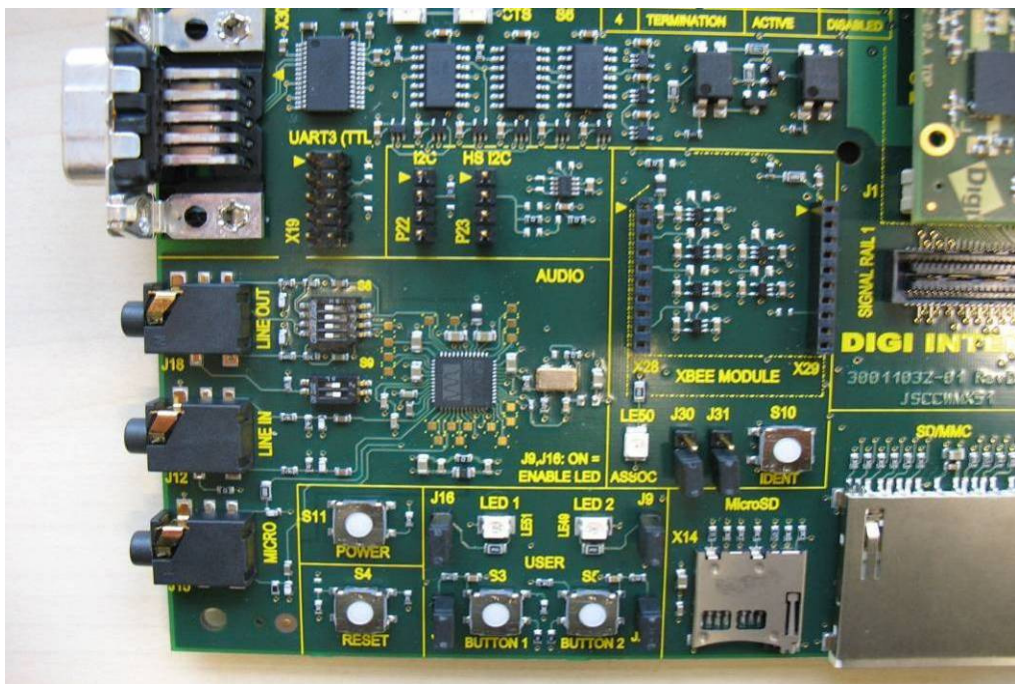

Photo 5: evaluation board with WLAN module



Photo 6: evaluation board with WLAN module

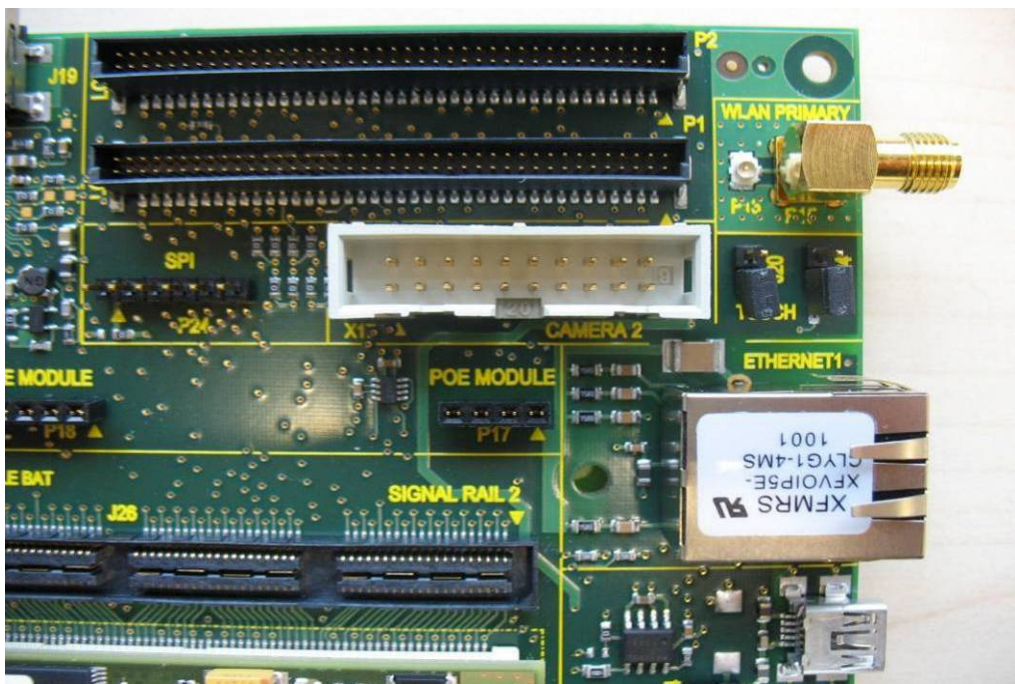

Photo 7: evaluation board with WLAN module

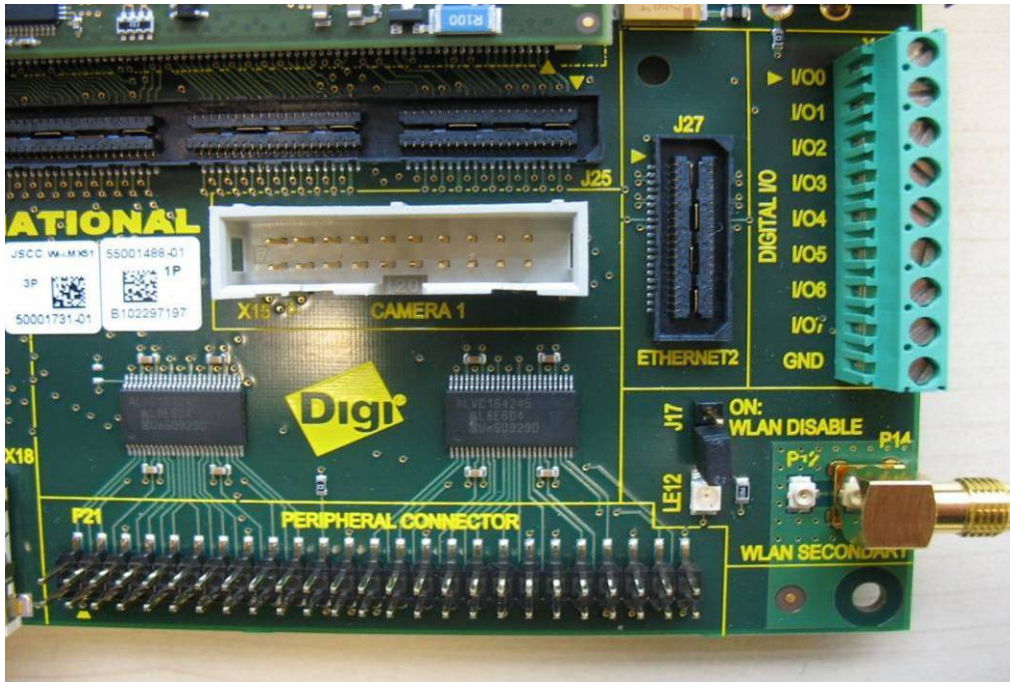

Photo 8: evaluation board with WLAN module



Photo 9: evaluation board with WLAN module



Photo 10: WLAN module

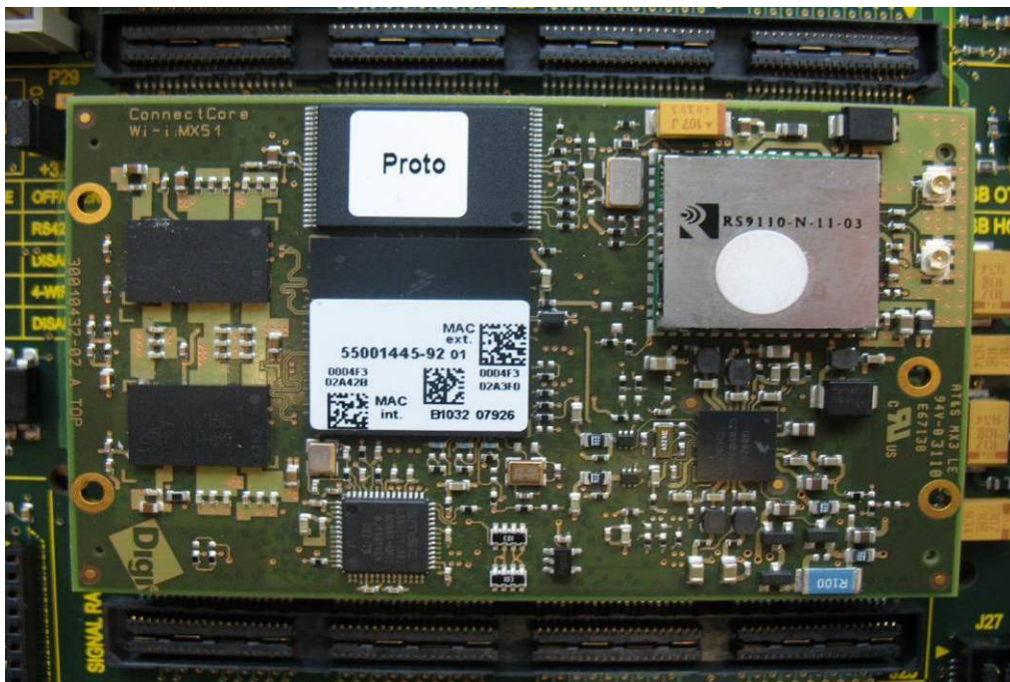

Photo 11: WLAN module



Photo 12: WLAN module



Photo 13: WLAN module, antenna ports RX and TX

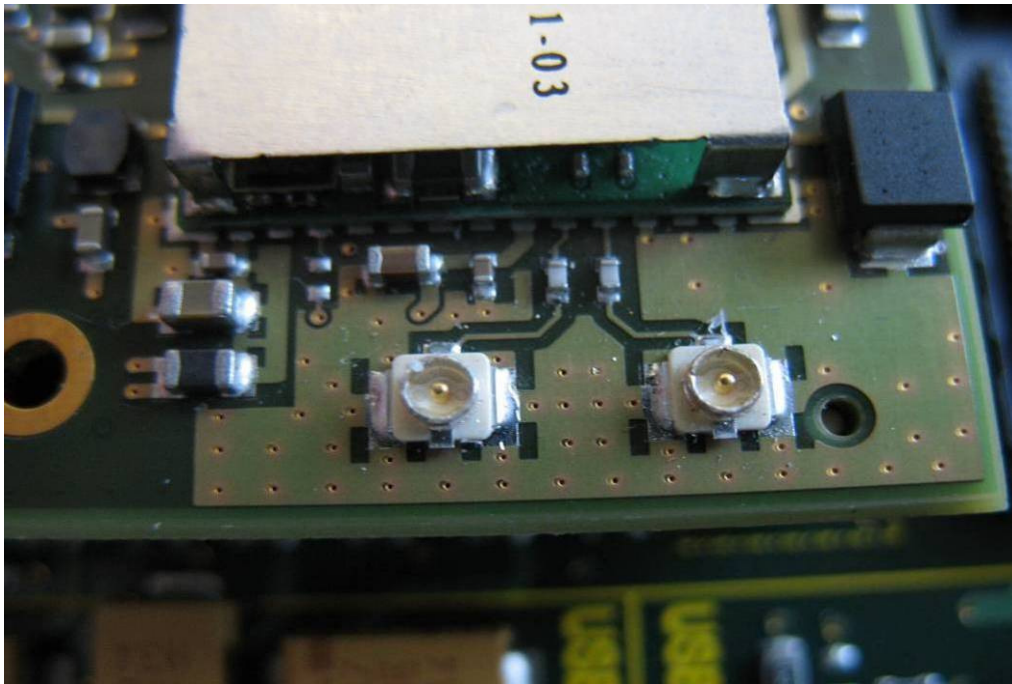

Photo 14: WLAN module

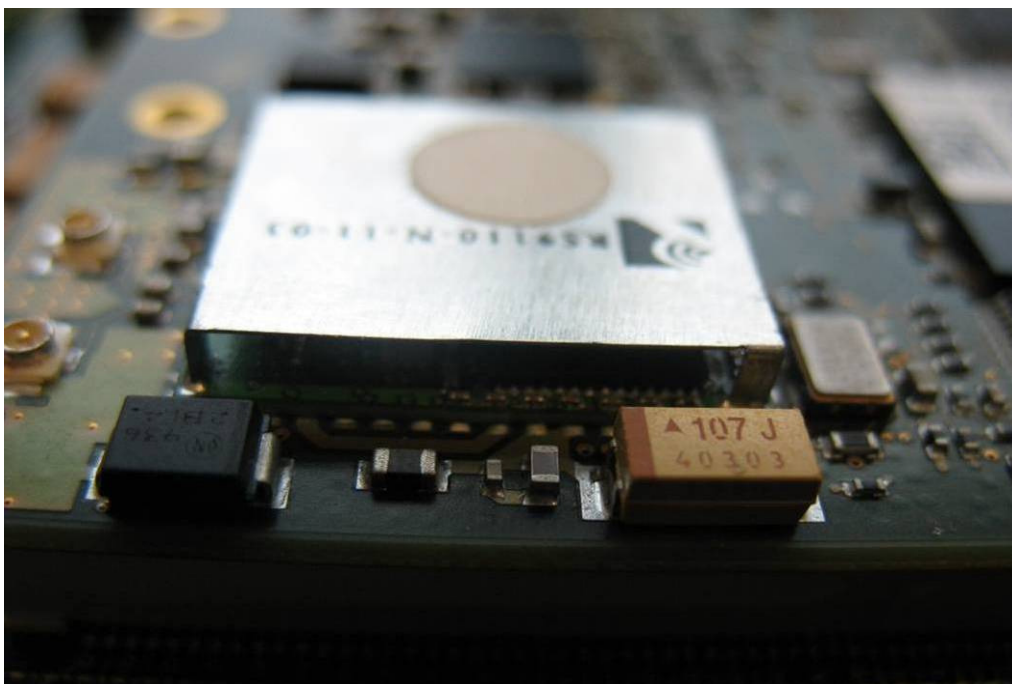

Photo 15: antenna

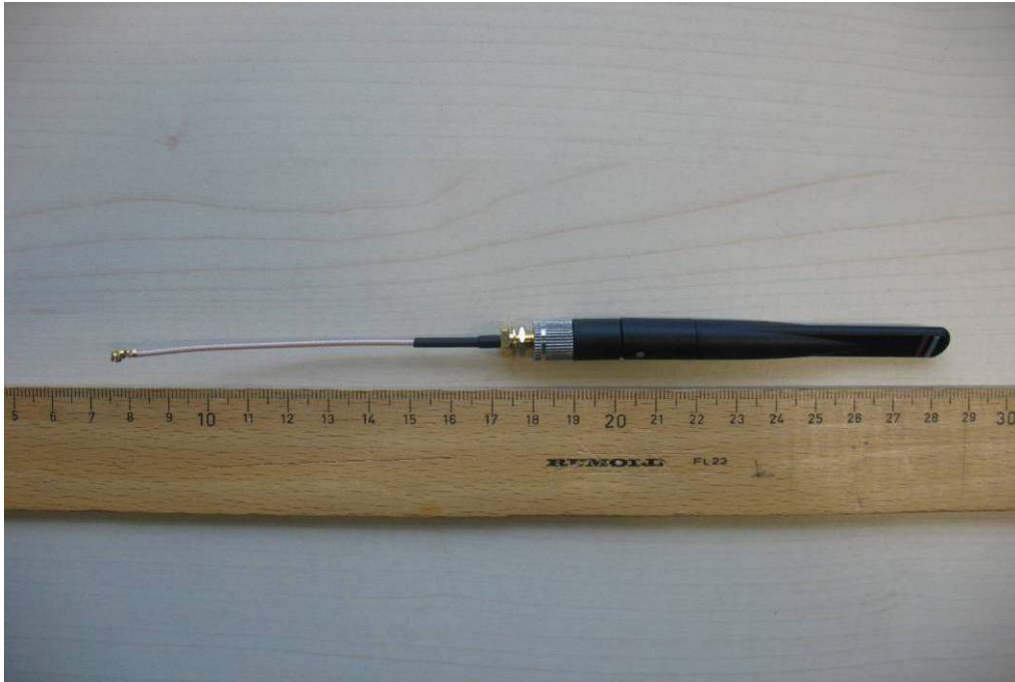

Photo 16: power supply



Photo 17: power supply



Photo 18: power supply



Photo 19: power supply



Photo 20: power supply



Photo 21: power supply



Annex C Internal photographs of the EUT

Photo documentation:

Photo 1: evaluation board

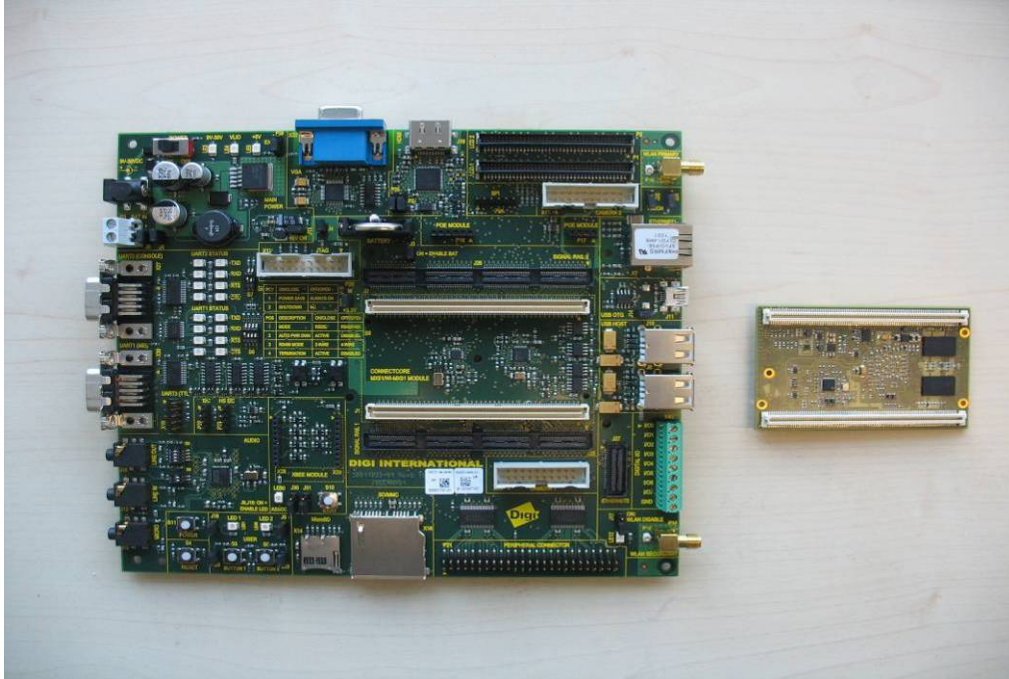

Photo 2: evaluation board

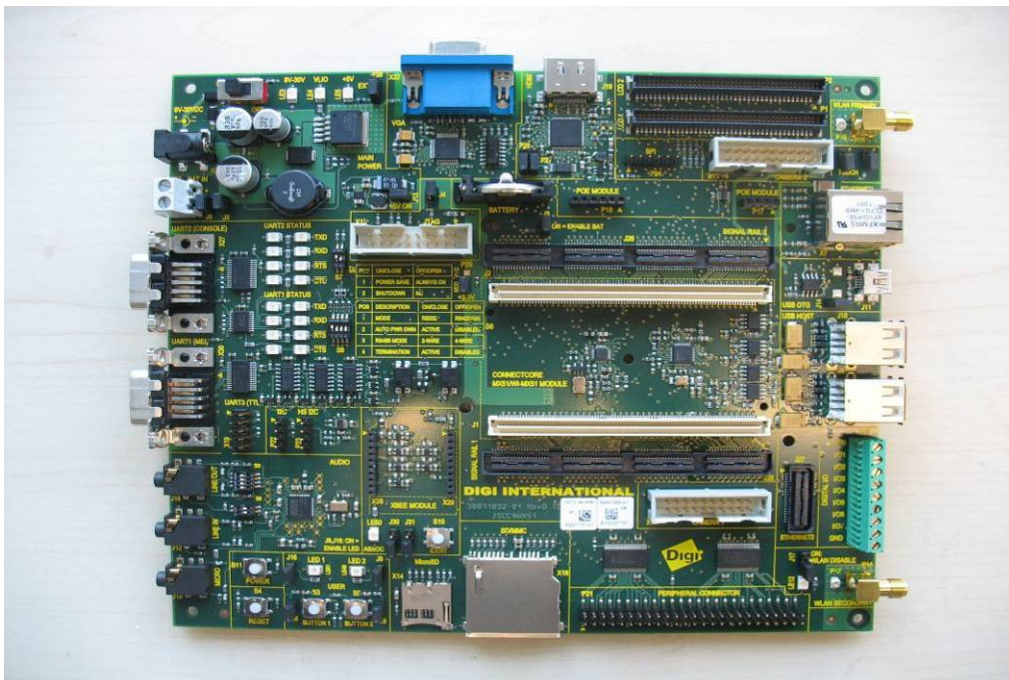

Photo 3: evaluation board

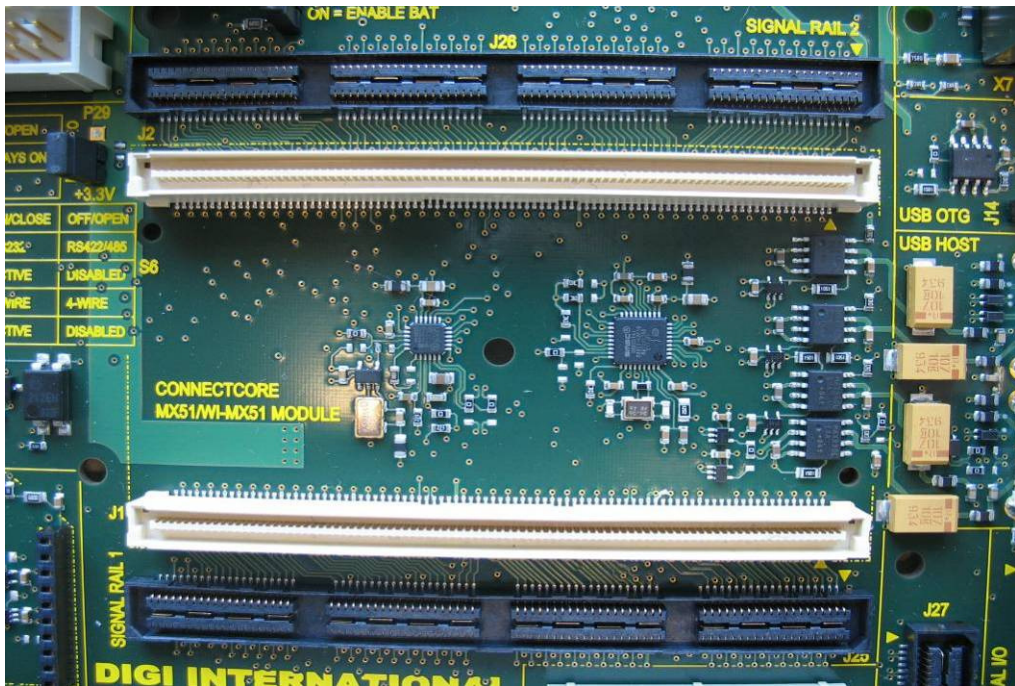

Photo 4: WLAN module / back side

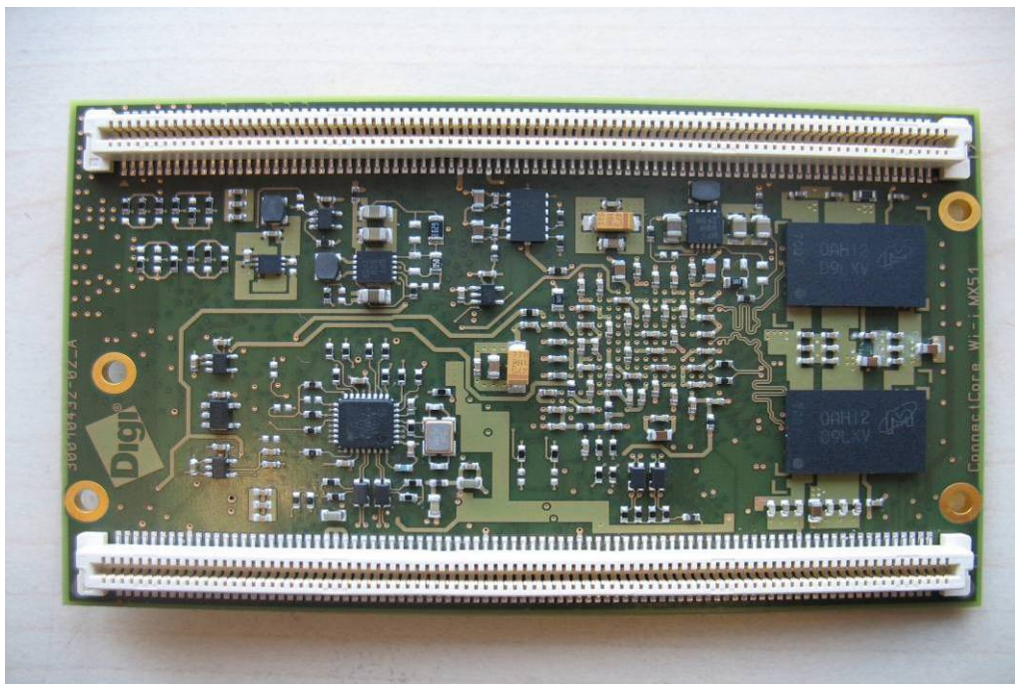

Photo 5: WLAN module / front side

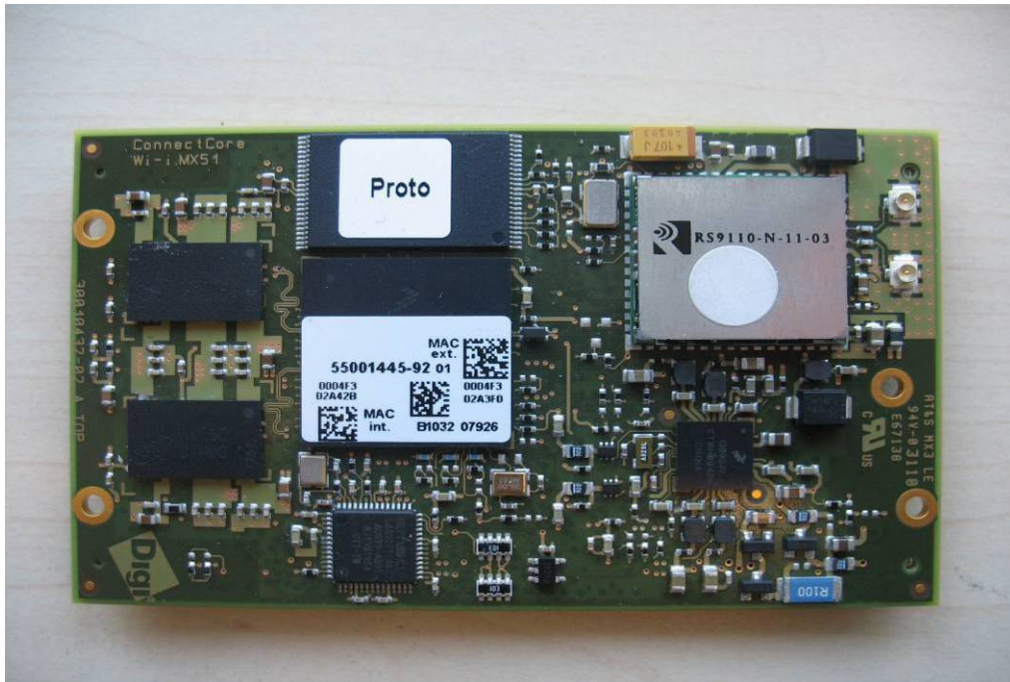

Photo 6: WLAN module / front side without shielding

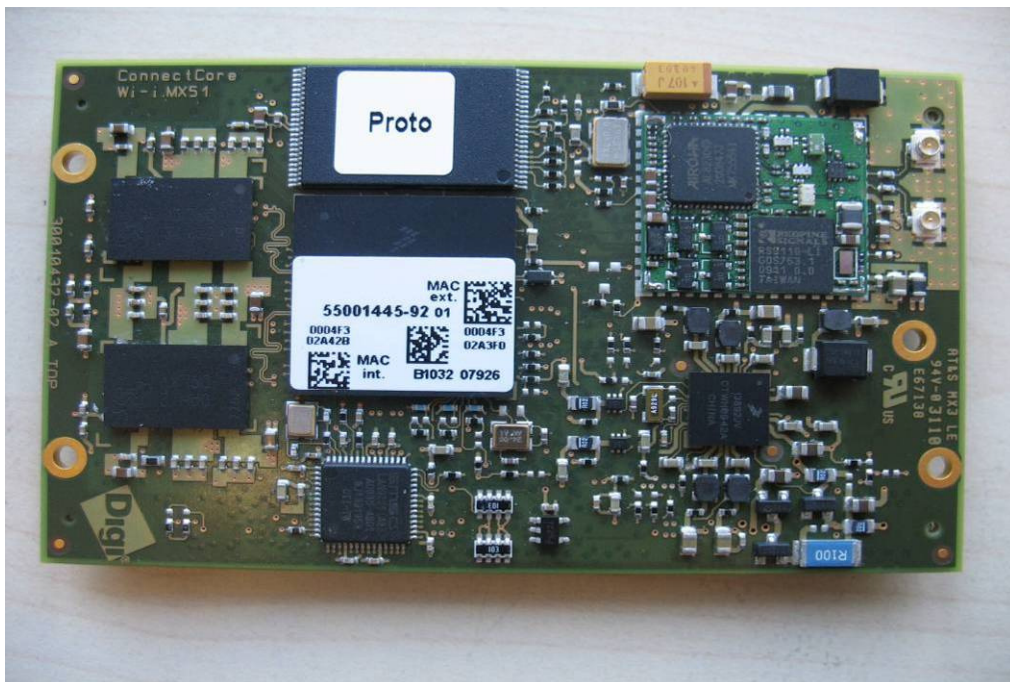
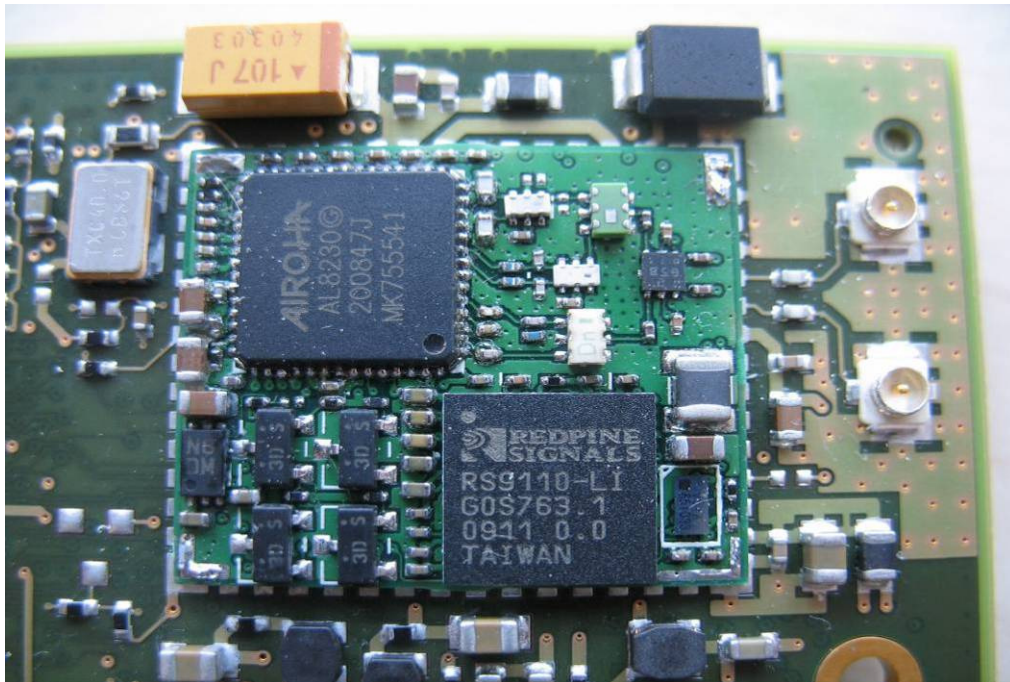

Photo 7: WLAN module / front side without shielding



Annex D Document history

Version	Applied changes	Date of release
1.0	Initial release	2011-03-10

Annex E Further information**Glossary**

DUT	-	Device under Test
EMC	-	Electromagnetic Compatibility
EUT	-	Equipment under Test
FCC	-	Federal Communication Commission
FCC ID	-	Company Identifier at FCC
HW	-	Hardware
IC	-	Industry Canada
Inv. No.	-	Inventory number
N/A	-	not applicable
S/N	-	Serial Number
SW	-	Software