

TEST REPORT

Test report no.: 1-1554-01-23/09



Testing laboratory

CETECOM ICT Services GmbH
Untertuerkheimer Strasse 6 – 10
66117 Saarbruecken / Germany
Phone: + 49 681 5 98 - 0
Fax: + 49 681 5 98 - 9075
Internet: <http://www.cetecom.com>
e-mail: ict@cetecom.com

Accredited test laboratory:

The test laboratory (area of testing) is accredited according to DIN EN ISO/IEC 17025
DAR registration number: DGA-PL-176/94-D1

Area of Testing: Radio/Satellite Communications

Applicant

Digi International GmbH
Branch Breisach
Kueferstr.8
79206 Breisach / Germany
Phone: -/
Fax: +49 7667 908 200
Contact: Andreas Ortlieb
e-mail: andreas.ortlieb@digicom.com
Phone: +49 7667 908 136

Manufacturer

Digi International GmbH
Branch Breisach
Kueferstr.8
79206 Breisach / Germany

Test standard/s

Arib T66

特定無線設備の技術基準適合証明等に関する規則

Ordinance concerning Technical Regulations Conformity Certification etc. of Specified Radio Equipment Article 2 clause (1) Item (19) (1)

For further applied test standards please refer to section 3 of this test report.

Test item

Kind of test item: WLAN Modul
Model name: ConnectCore Wi-i.Mx51
Frequency [MHz]: ISM band 2400 MHz to 2483.5 MHz
(Lowest channel 2412 MHz;
highest channel 2472 MHz)
Power supply: 100 V AC by AC/DC power supply
Temperature range: -20 °C to +55 °C



This test report is electronically signed and valid without handwriting signature. For verification of the electronic signatures, the public keys can be requested at the testing laboratory.

Test performed:

Marco Bertolino

Test report authorised:

Andreas Keller

1 Table of contents

1	Table of contents	2
2	General information	3
2.1	Notes	3
2.2	Application details	3
3	Test standard/s	3
4	Test environment.....	3
5	Test item	4
5.1	Cabinet	4
6	Test laboratories sub-contracted	4
7	Summary of measurement results	5
8	RF measurement testing.....	7
8.1	Description of test setup	7
8.1.1	Radiated measurements	7
8.1.2	Conducted measurements.....	9
8.2	Additional comments	9
8.3	Transmitter test results	10
8.3.1	Antenna gain	10
8.4	Maximum output power (conducted) / data rate.....	17
8.4.1	Antenna power (conducted) & tolerance of antenna power	28
8.4.2	Frequency tolerance	31
8.4.3	Modulation method	33
8.4.4	Spurious emission intensity - conducted	34
8.4.5	Spurious emissions intensity - radiated	59
8.4.6	Occupied & spreading bandwidth	78
8.4.7	Spreading factor.....	88
8.4.8	Staying time	88
8.4.9	Dwell time.....	89
8.4.10	Receiver – limit of secondarily emitted radio wave strength - conducted.....	93
8.4.11	Receiver – limit of secondarily emitted radio wave strength - radiated	95
8.4.12	Interference prevention function	98
8.4.13	Carrier sensing function	98
8.4.14	Enclosure requirements	98
9	Test equipment and ancillaries used for tests	99
Annex A	Photographs of the test setup	101
Annex B	External photographs of the EUT	106
Annex C	Internal photographs of the EUT	117
Annex D	Document history	121
Annex E	Further information.....	121

2 General information

2.1 Notes

The test results of this test report relate exclusively to the test item specified in this test report. CETECOM ICT Services GmbH does not assume responsibility for any conclusions and generalisations drawn from the test results with regard to other specimens or samples of the type of the equipment represented by the test item. The test report may only be reproduced or published in full. Reproduction or publication of extracts from the report requires the prior written approval of CETECOM ICT Services GmbH.

This test report is electronically signed and valid without handwriting signature. For verification of the electronic signatures, the public keys can be requested at the testing laboratory.

2.2 Application details

Date of receipt of order:	2009-10-26
Date of receipt of test item:	2011-02-17
Start of test:	2011-02-17
End of test:	2011-02-23
Person(s) present during the test:	-/-

3 Test standard/s

Test standard	Version	Test standard description
		特定無線設備の技術基準適合証明等に関する規則 Ordinance concerning Technical Regulations Conformity Certification etc. of Specified Radio Equipment Article 2 clause (1) Item (19) (1)
Arib T66	-/-	Ordinance Regulating Radio Equipment 無線設備規則 Ordinance Regulating Radio Equipment Chapter I General Provision Chapter II Transmitting Equipment Chapter III Receiving Equipment Chapter IV, Section 4.17, Article 49.20.1

4 Test environment

Temperature:	T_{nom}	+24 °C during room temperature tests
	T_{max}	+55 °C during high temperature test
	T_{min}	-20 °C during low temperature test
Relative humidity content:		60 %
Air pressure:		not relevant for this kind of testing
Power supply:	V_{nom}	100 V AC by AC/DC power supply
	V_{max}	110 V
	V_{min}	90 V

5 Test item

Kind of test item	:	WLAN Modul
Type identification	:	Connect Core Wi-i.Mx51
S/N serial number	:	Prototype 55001445-92
HW hardware status	:	No information available!
SW software status	:	No information available!
Frequency band [MHz]	:	2400 MHz to 2483.5 MHz – ISM band lowest channel 2412 MHz – highest channel 2472 MHz
Type of modulation	:	DSSS and OFDM technology with BPSK, QPSK, 16- & 64 QAM modulation
Number of channels	:	14 (channel 14 is tested in a separate test report: 1-1554-01-23/09)
Antenna	:	External rod antenna → for more information, please take a look at the annex B – external photos of the EUT.
Power supply	:	100 V AC by AC/DC power supply
Temperature range	:	-20 °C to +55 °C

5.1 Cabinet

Evaluation board:

Size	21.0 cm * 18.5 cm * 2.5 cm
Weight	50.83 g without WLAN module
Cabinet	No cabinet! (see photos for details)

Module:

Size	8.2 cm * 5.0 cm * 0.8 cm
Weight	26.35 g
Cabinet	No cabinet! (see photos for details)

6 Test laboratories sub-contracted

None

7 Summary of measurement results

<input checked="" type="checkbox"/>	No deviations from the technical specifications were ascertained
<input type="checkbox"/>	There were deviations from the technical specifications ascertained

TC identifier	Description	verdict	date	Remark
RF-Testing	特定無線設備の技術基準適合証明等に関する規則 Ordinance concerning Technical Regulations Conformity Certification etc. of Specified Radio Equipment Article 2 clause (1) Item (19) (1) Ordinance Regulating Radio Equipment 無線設備規則 Ordinance Regulating Radio Equipment Chapter I General Provision Chapter II Transmitting Equipment Chapter III Receiving Equipment Chapter IV, Section 4.17, Article 49.20.1	Pass	2011-02-24	-/-

Test Specification Clause	Test Case	temperature conditions	power source voltages	Mode	Pass	Fail	NA	NP	Remark
8.1	Antenna gain	Nominal	Nominal	DSSS	<input checked="" type="checkbox"/>	<input type="checkbox"/>	<input type="checkbox"/>	<input type="checkbox"/>	-/-
8.2	Antenna power (conducted) & tolerance of antenna power	Nominal	Nominal	DSSS OFDM	<input checked="" type="checkbox"/>	<input type="checkbox"/>	<input type="checkbox"/>	<input type="checkbox"/>	-/-
		Nominal	Low	DSSS OFDM	<input checked="" type="checkbox"/>	<input type="checkbox"/>	<input type="checkbox"/>	<input type="checkbox"/>	
		Nominal	High	DSSS OFDM	<input checked="" type="checkbox"/>	<input type="checkbox"/>	<input type="checkbox"/>	<input type="checkbox"/>	
8.3	Frequency tolerance	Nominal	Nominal	DSSS	<input checked="" type="checkbox"/>	<input type="checkbox"/>	<input type="checkbox"/>	<input type="checkbox"/>	-/-
				OFDM	<input checked="" type="checkbox"/>	<input type="checkbox"/>	<input type="checkbox"/>	<input type="checkbox"/>	
8.4	Modulation method	Nominal	Nominal	DSSS	<input checked="" type="checkbox"/>	<input type="checkbox"/>	<input type="checkbox"/>	<input type="checkbox"/>	-/-
				OFDM	<input checked="" type="checkbox"/>	<input type="checkbox"/>	<input type="checkbox"/>	<input type="checkbox"/>	
8.5	Spurious emission intensity - conducted	Nominal	Nominal	DSSS	<input checked="" type="checkbox"/>	<input type="checkbox"/>	<input type="checkbox"/>	<input type="checkbox"/>	-/-
				OFDM	<input checked="" type="checkbox"/>	<input type="checkbox"/>	<input type="checkbox"/>	<input type="checkbox"/>	
8.6	Spurious emission intensity - radiated	Nominal	Nominal	DSSS	<input checked="" type="checkbox"/>	<input type="checkbox"/>	<input type="checkbox"/>	<input type="checkbox"/>	-/-
				OFDM	<input checked="" type="checkbox"/>	<input type="checkbox"/>	<input type="checkbox"/>	<input type="checkbox"/>	
8.5	Occupied & spreading bandwidth	Nominal	Nominal	DSSS	<input checked="" type="checkbox"/>	<input type="checkbox"/>	<input type="checkbox"/>	<input type="checkbox"/>	-/-
				OFDM	<input checked="" type="checkbox"/>	<input type="checkbox"/>	<input type="checkbox"/>	<input type="checkbox"/>	
8.8	Spreading factor	Nominal	Nominal	-/-	<input checked="" type="checkbox"/>	<input type="checkbox"/>	<input type="checkbox"/>	<input type="checkbox"/>	-/-
8.9	Staying time	Nominal	Nominal	DSSS	<input checked="" type="checkbox"/>	<input type="checkbox"/>	<input type="checkbox"/>	<input type="checkbox"/>	-/-
				OFDM	<input checked="" type="checkbox"/>	<input type="checkbox"/>	<input type="checkbox"/>	<input type="checkbox"/>	

8.10	Receiver – limit of secondarily emitted radio wave strength – conducted	Nominal	Nominal	-/-	<input checked="" type="checkbox"/>	<input type="checkbox"/>	<input type="checkbox"/>	<input type="checkbox"/>	-/-
8.11	Receiver – limit of secondarily emitted radio wave strength - radiated	Nominal	Nominal	-/-	<input checked="" type="checkbox"/>	<input type="checkbox"/>	<input type="checkbox"/>	<input type="checkbox"/>	-/-
8.12	Control equipment	Nominal	Nominal	-/-	<input checked="" type="checkbox"/>	<input type="checkbox"/>	<input type="checkbox"/>	<input type="checkbox"/>	-/-
8.13	Connection to telecommunications carrier's facilities	Nominal	Nominal	-/-	<input type="checkbox"/>	<input type="checkbox"/>	<input checked="" type="checkbox"/>	<input type="checkbox"/>	-/-

Note:

NA = Not applicable; NP = Not performed

8 RF measurement testing

8.1 Description of test setup

8.1.1 Radiated measurements

The radiated emissions from the EUT are performed in a fully anechoic chamber. The EUT is placed on a non conductive turntable and powered with nominal voltage. The signalling is performed either from outside the chamber with a signalling unit (AP or other) by air link using a signalling antenna or directly by special test software from the customer.

Fully anechoic chamber

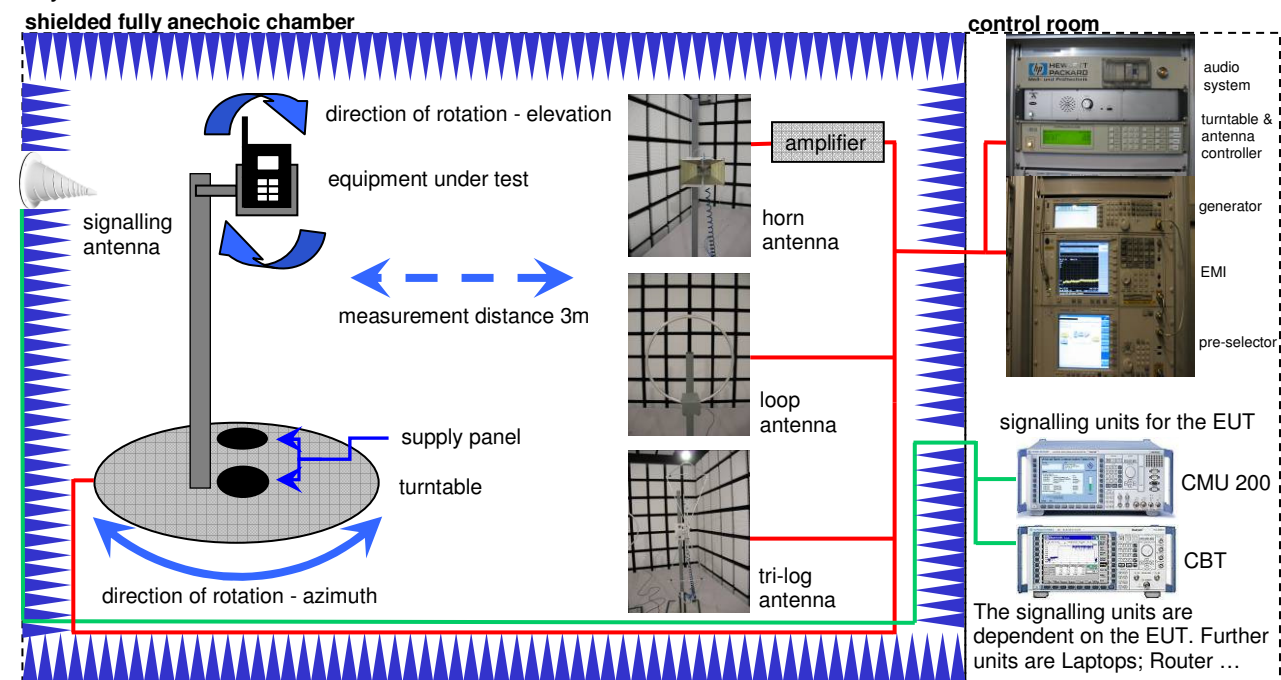

Picture 1: Diagram radiated measurements

9 kHz - 30 MHz: active loop antenna

30 MHz - 1GHz: tri-log antenna

>1GHz: horn antenna

OTA chamber:

The Rectangular Chamber consists of a shielded enclosure constructed of rigid steel panels. The chamber is treated with pyramidal and wedge shaped absorbers. Lighting in the chamber is RF-filtered and consists of four incandescent lamps mounted in recessed waveguide vents in the chamber ceiling. A single leaf swing type shielded door is provided for equipment and personal access into the chamber. The Anechoic Rectangular Chamber is capable of meeting RF attenuation level better than 100 dB throughout the frequency range of 700 MHz to 18 GHz, so that testing performed within the chamber does not interfere with other testing activities at the facility and vice versa. Power is supplied on separate circuits to the chamber and control area. All power filters provide a minimum of 100 dB attenuation over a frequency range of 14 kHz to 18 GHz if tested per MIL STD 220A.

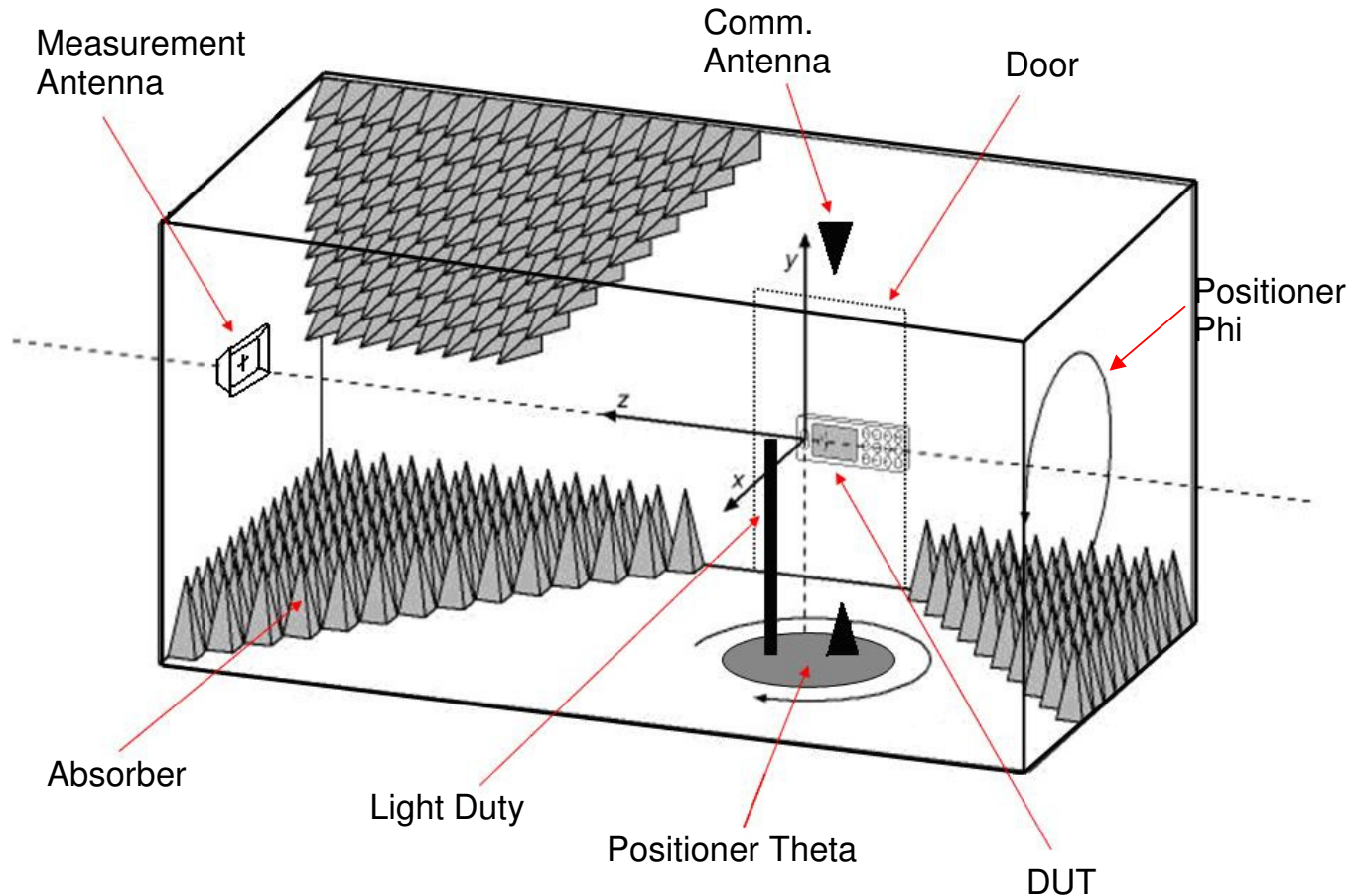
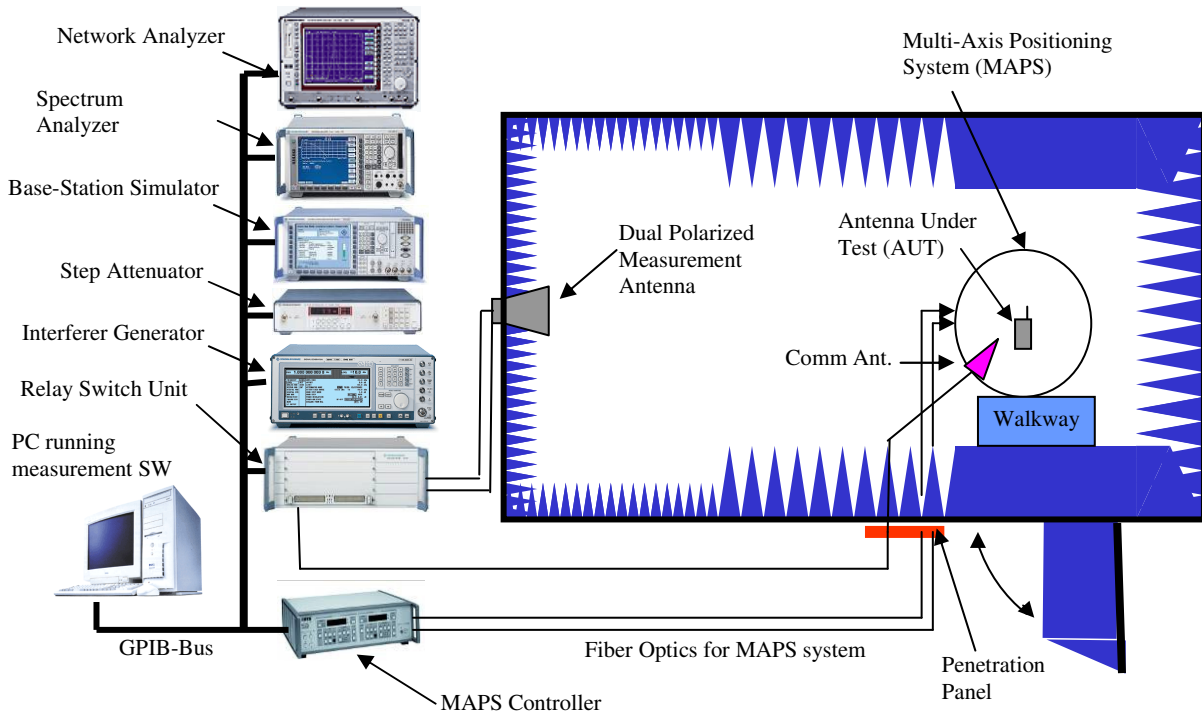

8.1.2 Conducted measurements

The EUT's RF signal is coupled out by the antenna connector which is supplied by the manufacturer. The signal is first 10dB attenuated before it is power divided (~6dB loss per branch). One of the signal paths is connected to the signalling unit (AP or other), the other one is connected to the spectrum analyzer. The specific losses for both signal paths are first checked within a calibration. The measurement readings on the signalling unit/spectrum analyzer are corrected by the specific test set-up loss. The attenuator, power divider, signalling unit and the spectrum analyzer are impedance matched on 50 Ohm. If special software is used, there is no power divider necessary.

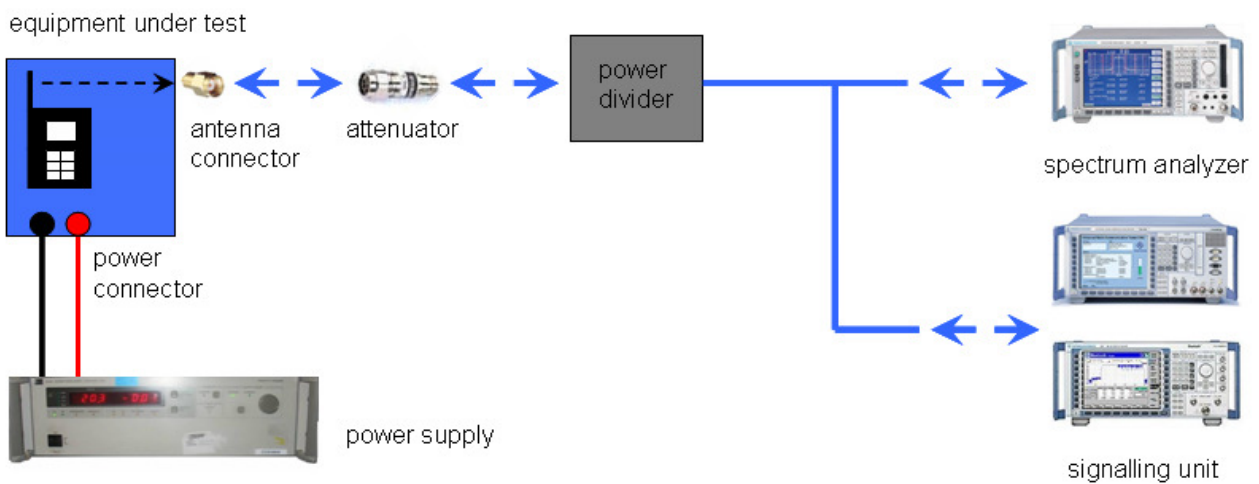

Picture 2: Diagram conducted measurements

The term measuring receiver refers to either a selective voltmeter or a spectrum analyser.

Frequency being measured f	Measuring receiver bandwidth 6 dB	Spectrum analyser bandwidth 3dB
$f < 150 \text{ kHz}$	200 Hz or	300 Hz
$150 \text{ kHz} \leq f < 25 \text{ MHz}$	9 kHz or	10 kHz
$25 \text{ MHz} \leq f < 1000 \text{ MHz}$	120 kHz or	100 kHz
$1000 \text{ MHz} \leq f$		1 MHz
NOTE: Specific requirements in CEPT/ERC/Recommendation 70-03 [2] shall be applied where applicable.		

8.2 Additional comments

Provided channels: 2412 MHz, 2417 MHz, 2422 MHz, 2427 MHz, 2432 MHz, 2437 MHz, 2442 MHz, 2447 MHz, 2452 MHz, 2457 MHz, 2462 MHz, 2467 MHz, 2472 MHz, 2484 MHz

8.3 Transmitter test results

8.3.1 Antenna gain

The antenna gain is calculated by the difference of radiated power in EIRP and the conducted power of the module. Caused by the large emission bandwidth of more than 10 MHz the gain is by comparing the measurement results of the radiated and conducted measurement using a RBW of 1 MHz. So these results don't reflect the total radiated power of the EUT.

Measurement parameter	
Detector:	RMS
Sweep time:	20s
Resolution bandwidth:	1 MHz
Video bandwidth:	3 MHz
Span:	Zero span
Trace-Mode:	Max Hold
Additional EUT parameters:	Test mode (modulated carrier) DSSS modulation used Max power

Results:

	lowest channel 2412 MHz	mid channel 2442 MHz	highest channel 2472 MHz
Conducted peak power [dBm] DSSS (measured)	2.86	2.44	2.27
Radiated peak power [dBm] DSSS (measured)EIRP*)	6.12	5.83	5.61
Gain [dBi] calculated	3.26	3.39	3.34

*) max found peak (see Annex Antenna Diagram)

Limit:

only applicable if radiated peak power exceeds 12.14 dBm EIRP	
using none-directional antenna: No	
Limit Antenna Gain	Max 2.14 dBi
using directional antenna: Yes	
Measured Max gain [dBi]:	No opening angle calculation needed – the maximum radiated output power is below the 12.14 dBm EIRP limit!
Calculated Antenna Factor A [dB]= Max gain- 2.14dB [dB]:	
Calculated Antenna Factor A [lin]= 10^(A [dB]/10) :	
Max allowed Antenna opening angle (sum 3dB) [°]	
Verdict	

Result: The result of the measurement is passed.

Plots:

Plot 1: Antenna diagram lowest channel (vertical) – all values are in dBm

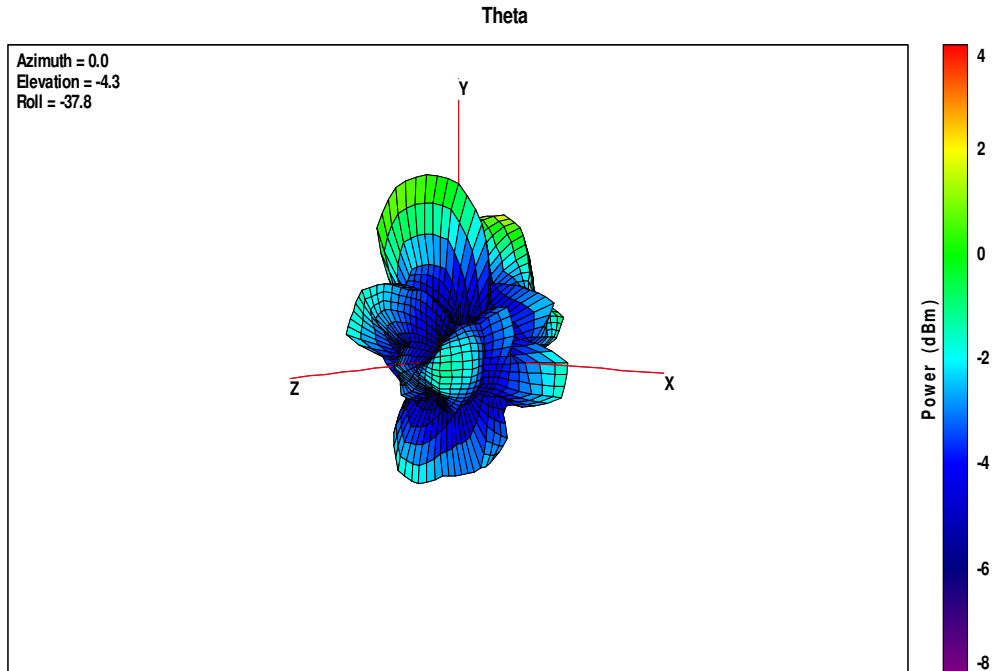

Plot 2: Antenna diagram lowest channel (horizontal) – all values are in dBm

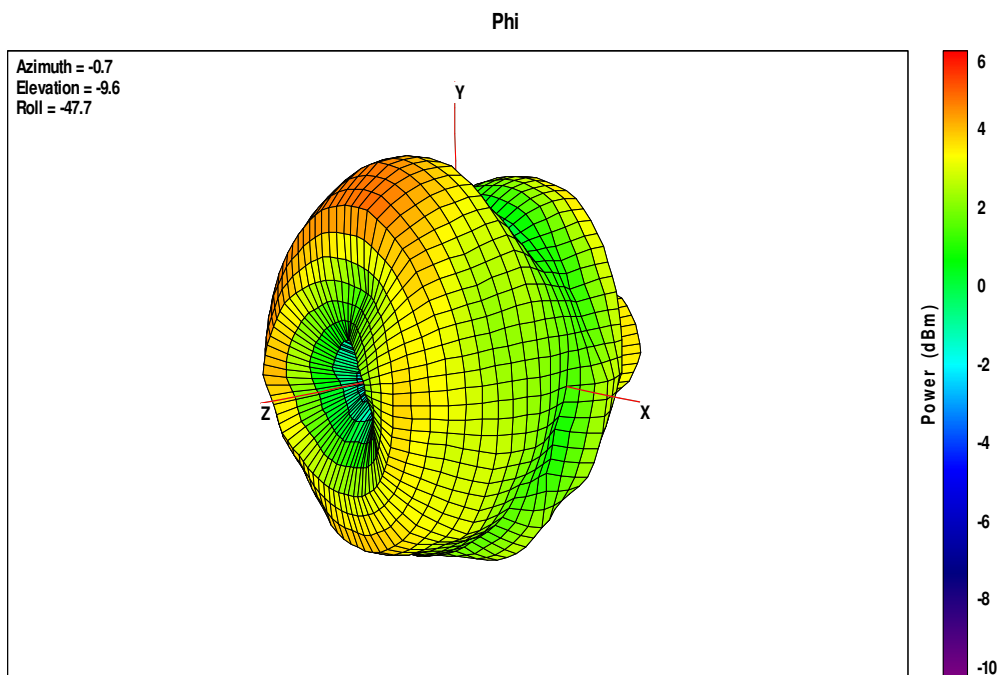

Plot 3: Antenna diagram lowest channel (vertical & horizontal – vectorial summation) – all values are in dBm

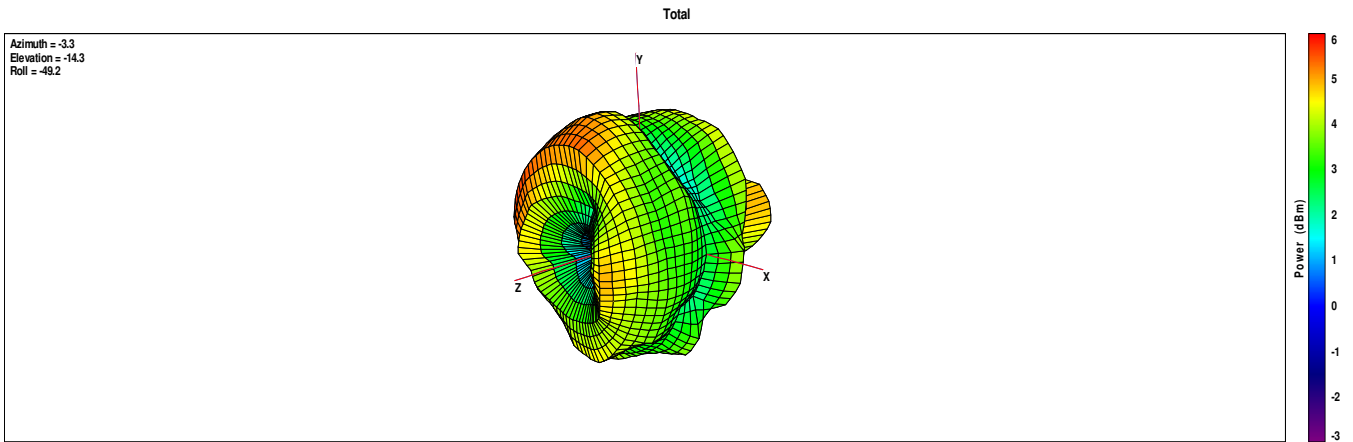

Plot 4: Antenna diagram middle channel (vertical) – all values are in dBm

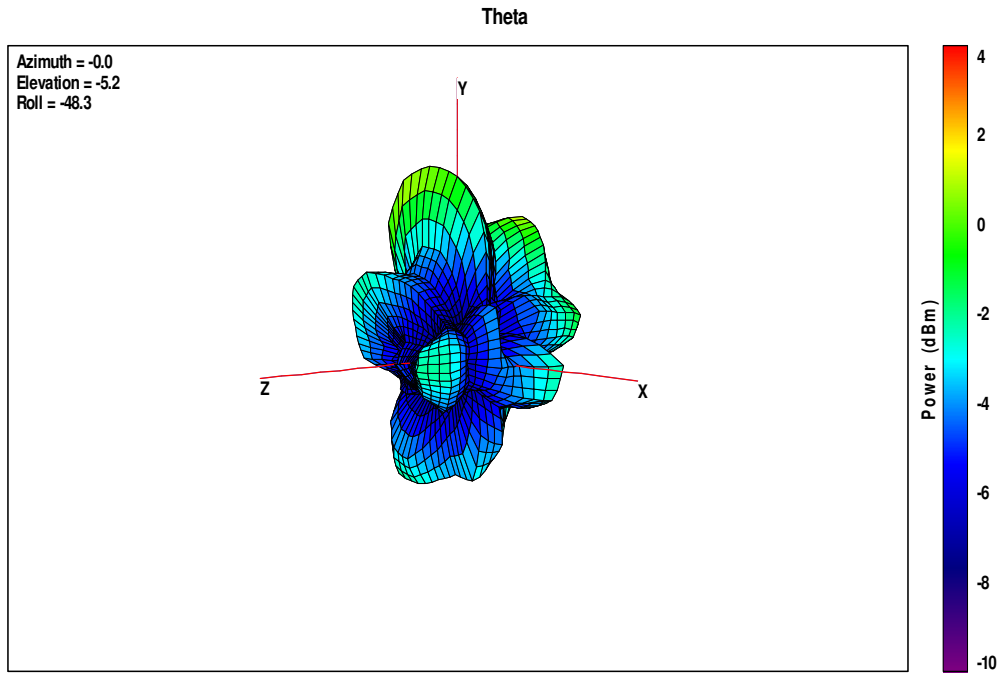

Plot 5: Antenna diagram middle channel (horizontal) – all values are in dBm

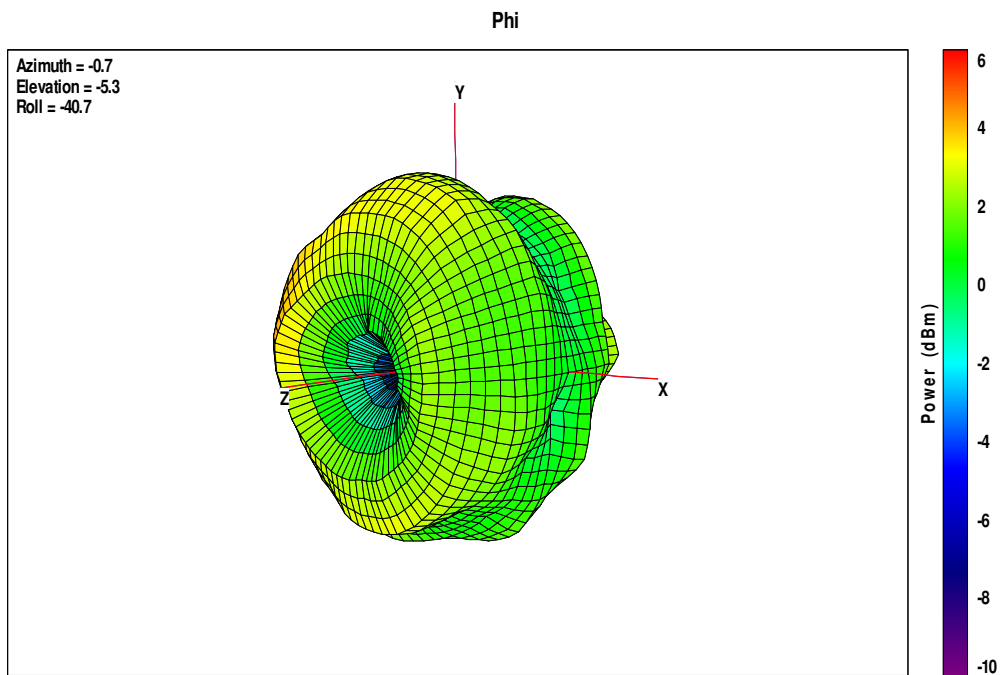

Plot 6: Antenna diagram middle channel (vertical & horizontal – vectorial summation) – all values are in dBm

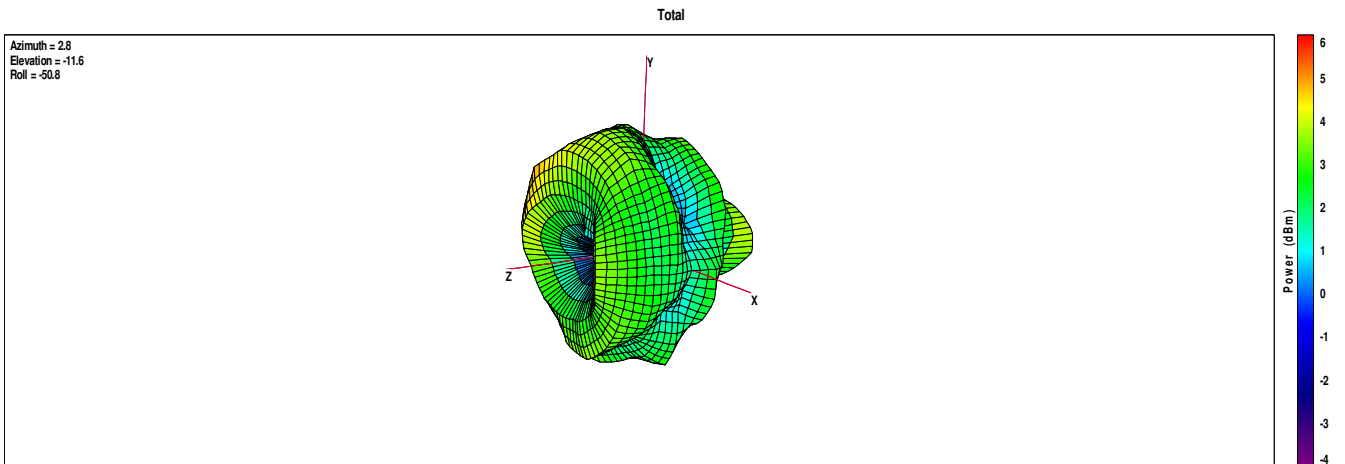

Plot 7: Antenna diagram highest channel (vertical) – all values are in dBm

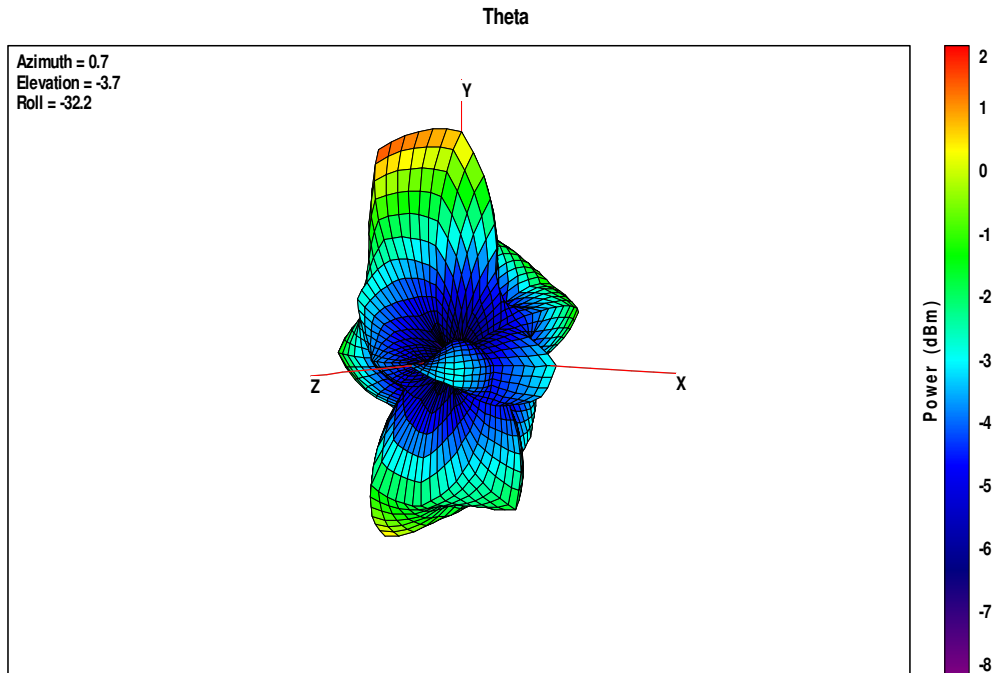

Plot 8: Antenna diagram highest channel (horizontal) – all values are in dBm

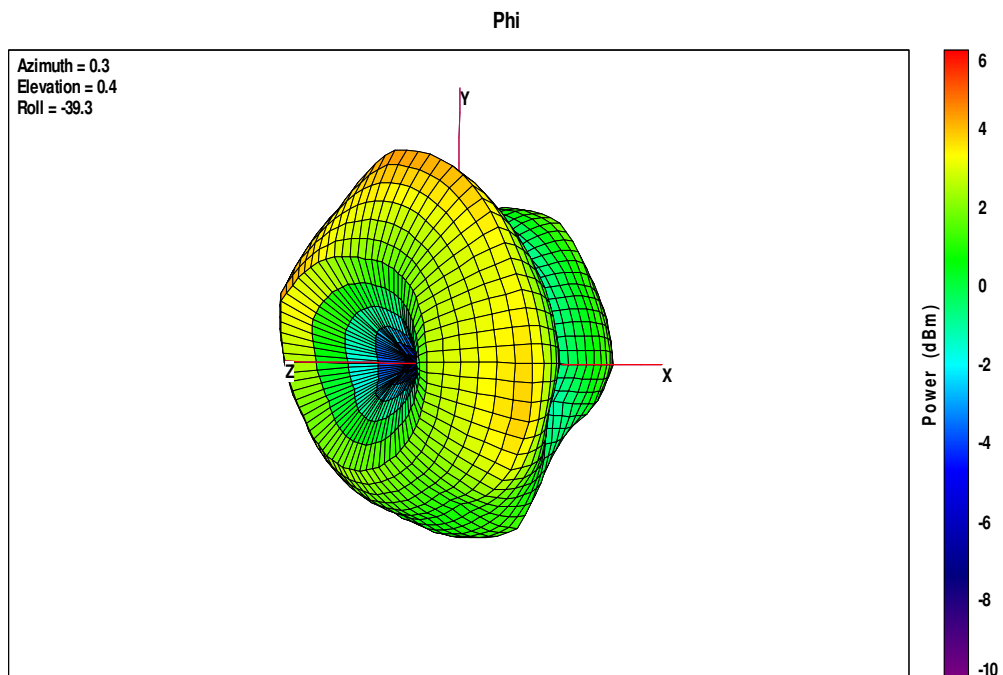

Plot 9: Antenna diagram highest channel (vertical & horizontal – vectorial summation) – all values are in dBm

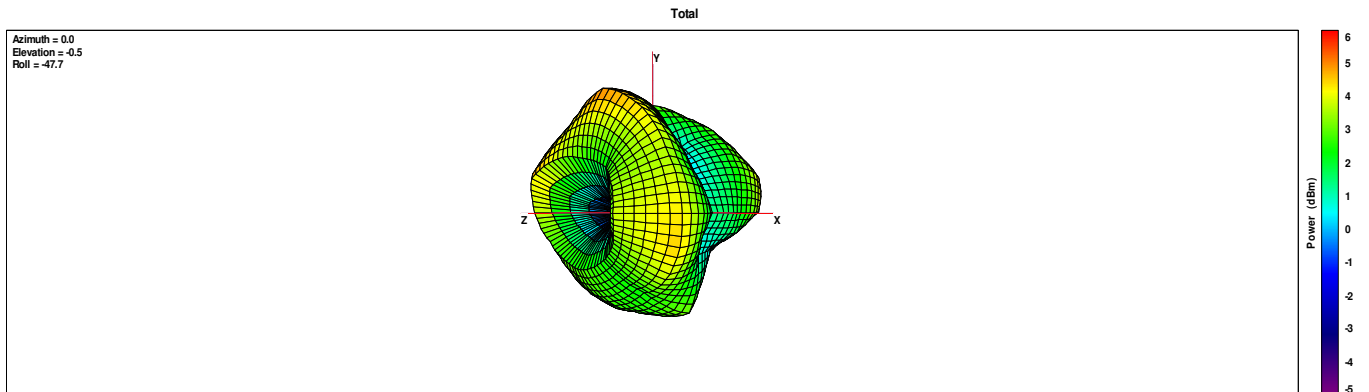

8.4 Maximum output power (conducted) / data rate

Description:

Measurement of the maximum output power conducted. This measurement is performed only at the middle channel in both modes and all data rates to determine the data rate per mode which results in the highest output power. This mode will be selected for all further measurements.

The used measurement settings are for the data rate verification only and not a passed / fail criteria.

Measurement:

Measurement parameter	
Detector:	Peak
Sweep time:	Auto
Video bandwidth:	30 MHz
Resolution bandwidth:	50 MHz
Span:	100 MHz
Trace-Mode:	Max Hold

Results:

DSSS Data Rate [MBit/s]	Maximum Output Power Conducted [dBm]			
	1	2	5.5	11
Ch 6 - 2437 MHz	15.31	15.32	15.38	15.39
Measurement uncertainty	± 0.5 dB			

OFDM Data Rate [MBit/s]	Maximum Output Power Conducted [dBm]							
	6	9	12	18	24	36	48	54
Ch 6 - 2437 MHz	18.14	18.13	18.16	18.02	18.17	18.01	18.06	18.09
Measurement uncertainty	± 0.5 dB							

OFDM Data Rate [MBit/s]	Maximum Output Power Conducted [dBm]							
	MCS 0	MCS 1	MCS 2	MCS 3	MCS 4	MCS 5	MCS 6	MCS 7
Ch 6 - 2437 MHz	19.09	19.04	19.28	18.92	19.18	19.25	19.15	19.29
Measurement uncertainty	± 0.5 dB							

Result: Selected data rate for all measurements:

DSSS:

OFDM g mode:

OFDM n mode:

11 MBit/s

24 MBit/s

MCS 7

Plot 1: DSSS mode, 1 MBit/s, channel 6, power index 45

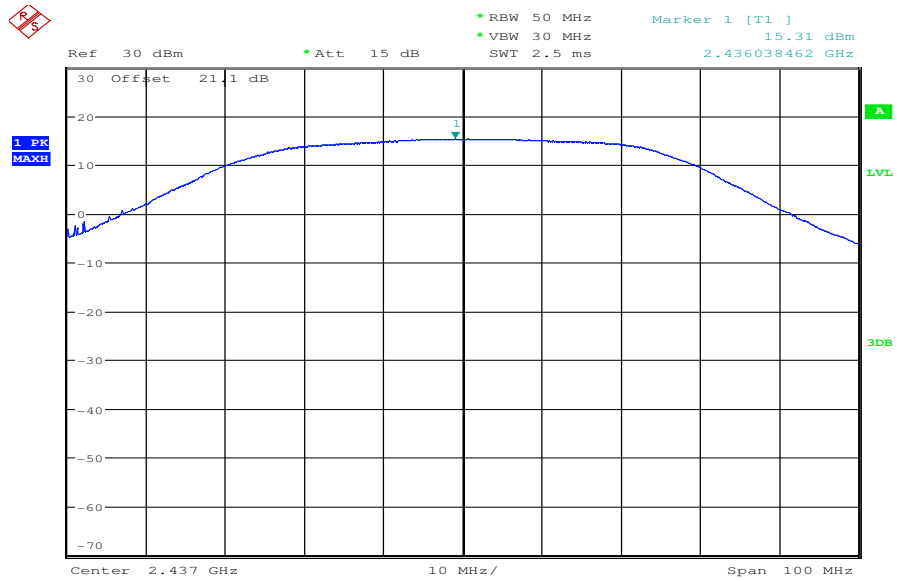

Date: 5.OCT.2010 10:16:58

Plot 2: DSSS mode, 2 MBit/s, channel 6, power index 45

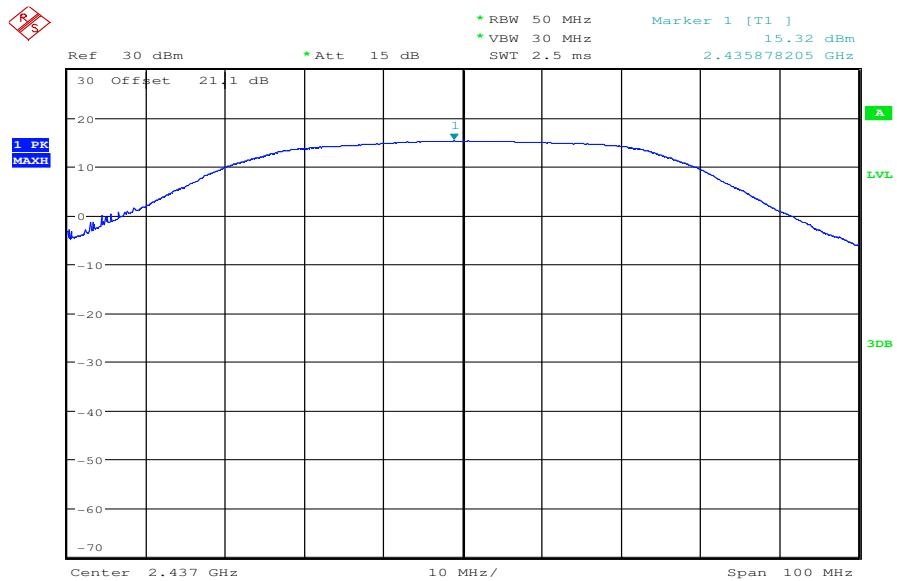

Date: 5.OCT.2010 10:18:05

Plot 3: DSSS mode, 5.5 MBit/s, channel 6, power index 45

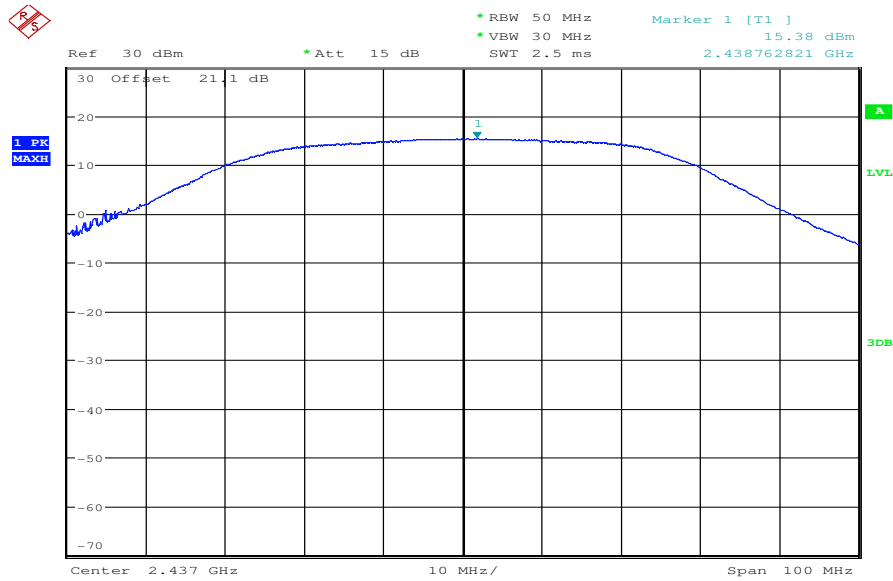

Date: 5.OCT.2010 10:19:20

Plot 4: DSSS mode, 11 MBit/s, channel 6, power index 45

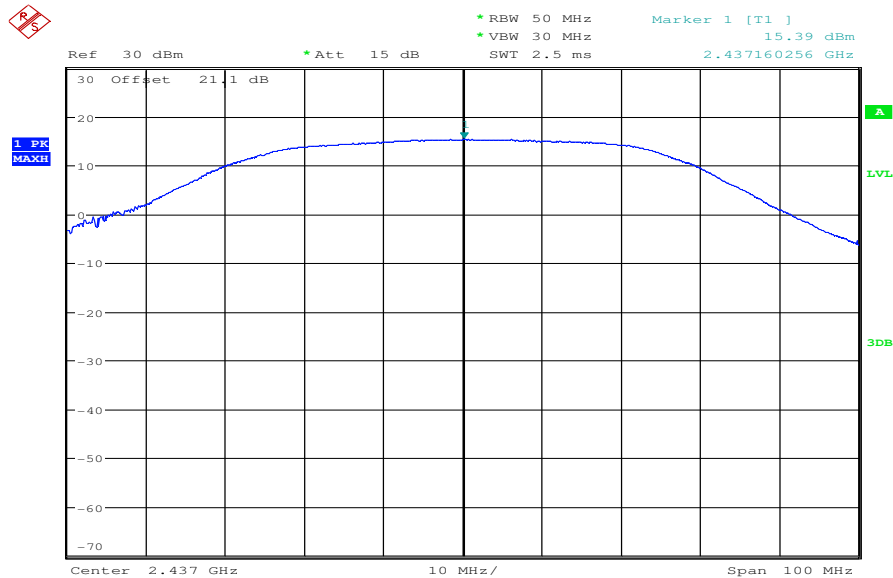

Date: 5.OCT.2010 10:21:11

Plot 5: OFDM, g – mode, 6 MBit/s, channel 6, power index 45

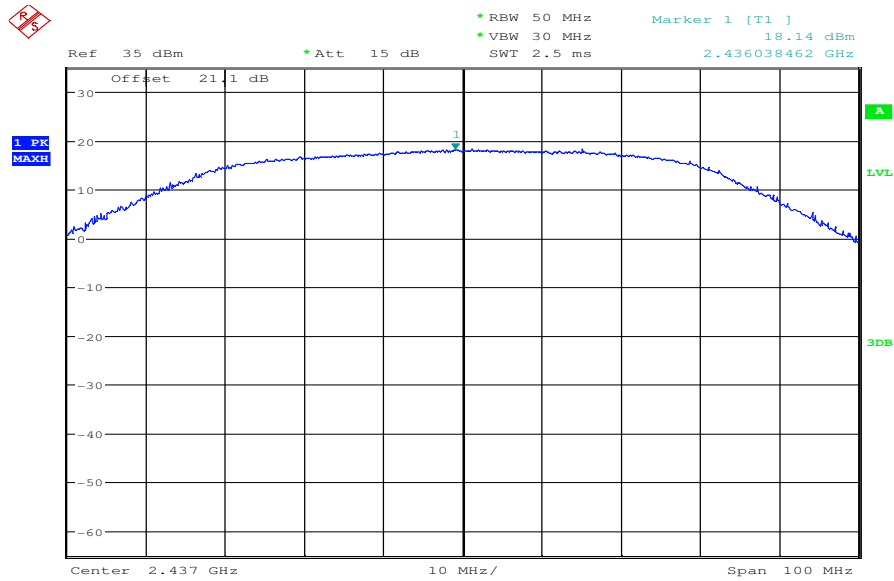

Date: 5.OCT.2010 08:55:14

Plot 6: OFDM, g – mode, 9 MBit/s, channel 6, power index 45

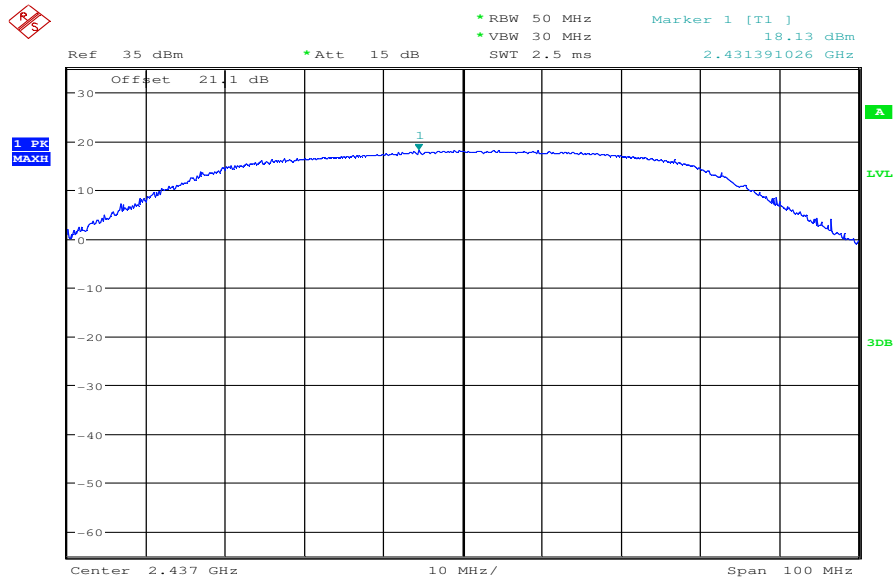

Date: 5.OCT.2010 08:56:22

Plot 7: OFDM, g – mode, 12 MBit/s, channel 6, power index 45

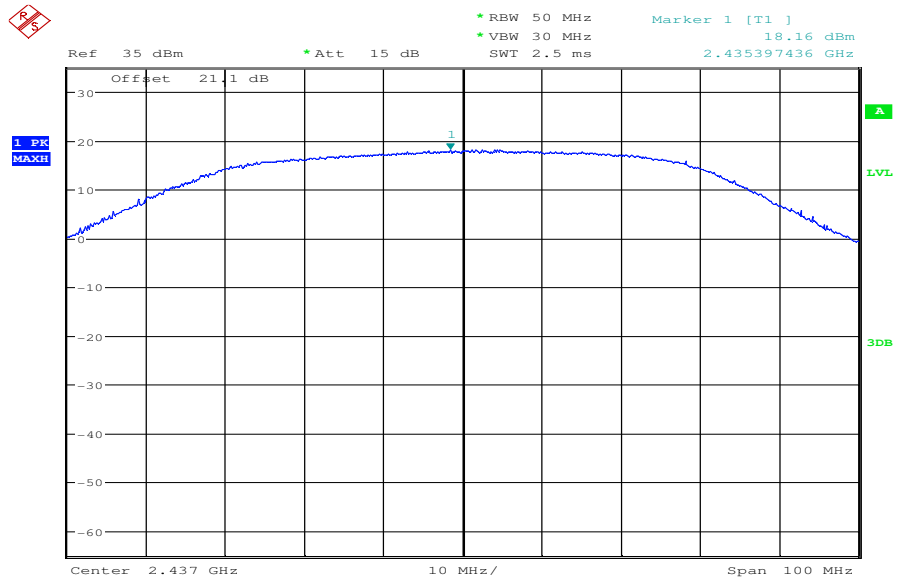

Date: 5.OCT.2010 08:57:24

Plot 8: OFDM, g – mode, 18 MBit/s, channel 6, power index 45

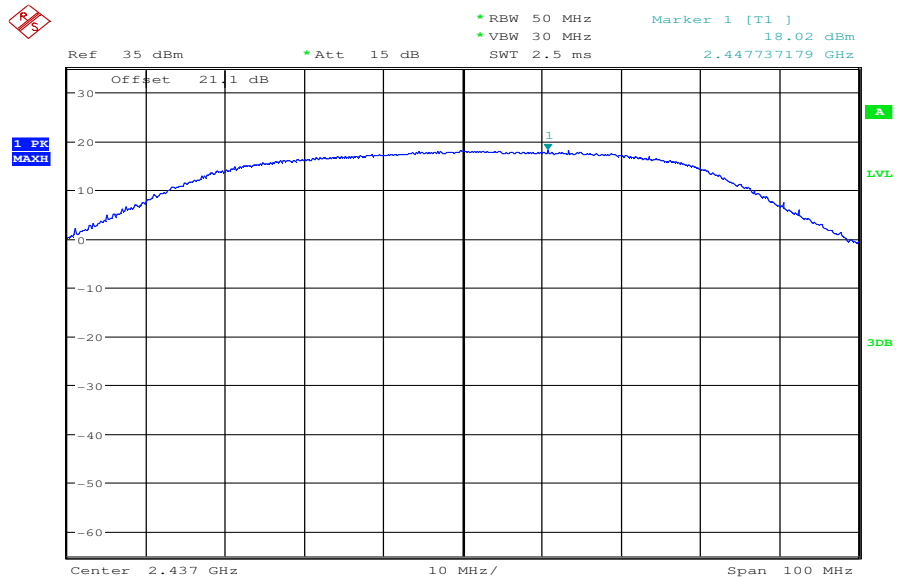

Date: 5.OCT.2010 08:58:35

Plot 9: OFDM, g – mode, 24 MBit/s, channel 6, power index 45

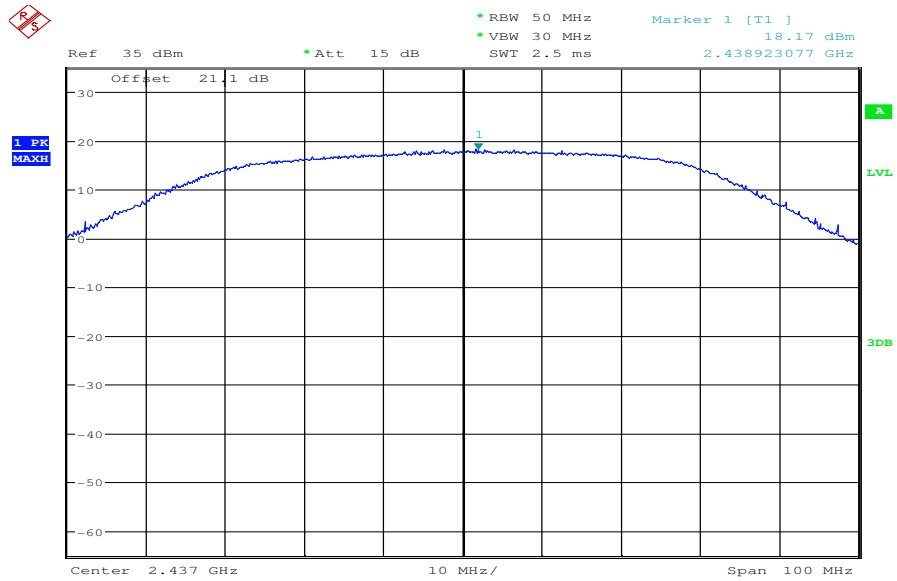

Date: 5.OCT.2010 09:00:33

Plot 10: OFDM, g – mode, 36 MBit/s, channel 6, power index 45

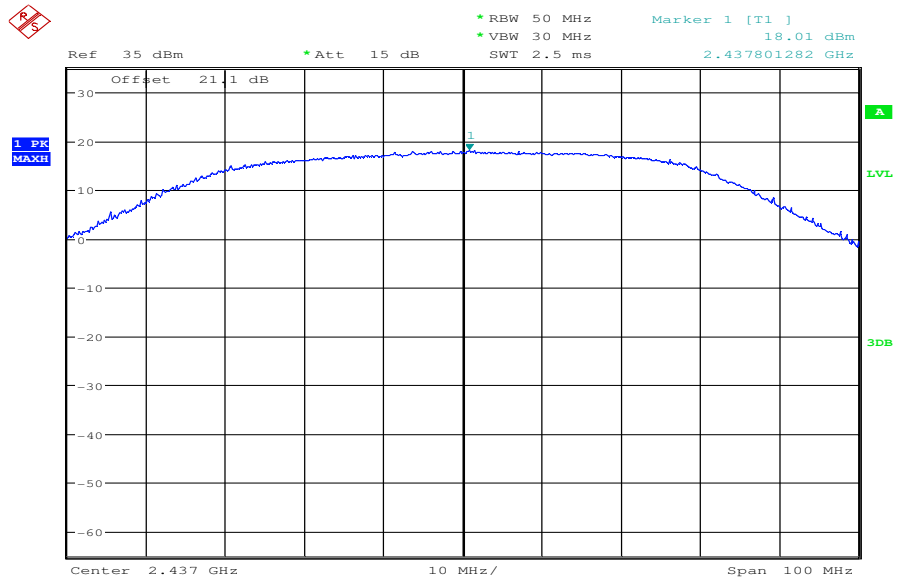

Date: 5.OCT.2010 09:01:27

Plot 11: OFDM, g – mode, 48 MBit/s, channel 6, power index 45

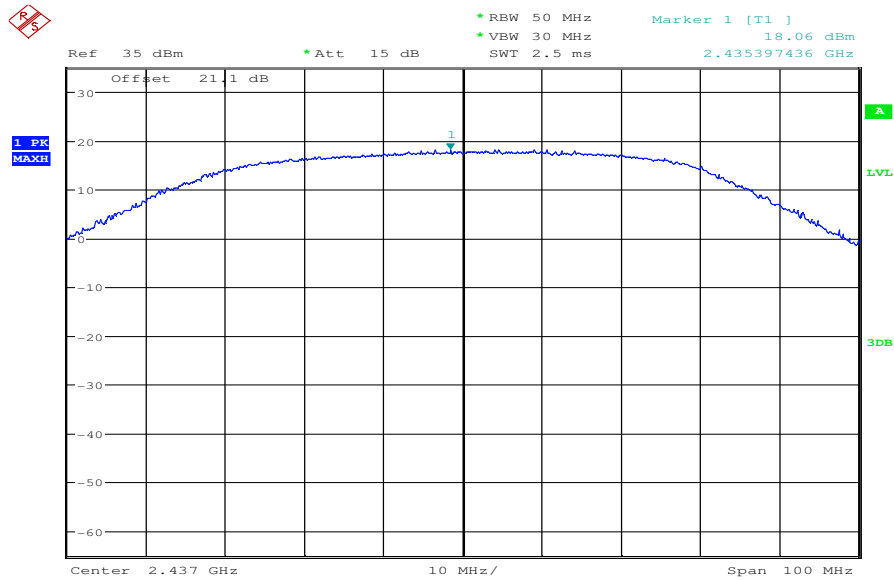

Date: 5.OCT.2010 09:02:34

Plot 12: OFDM, g – mode, 54 MBit/s, channel 6, power index 45

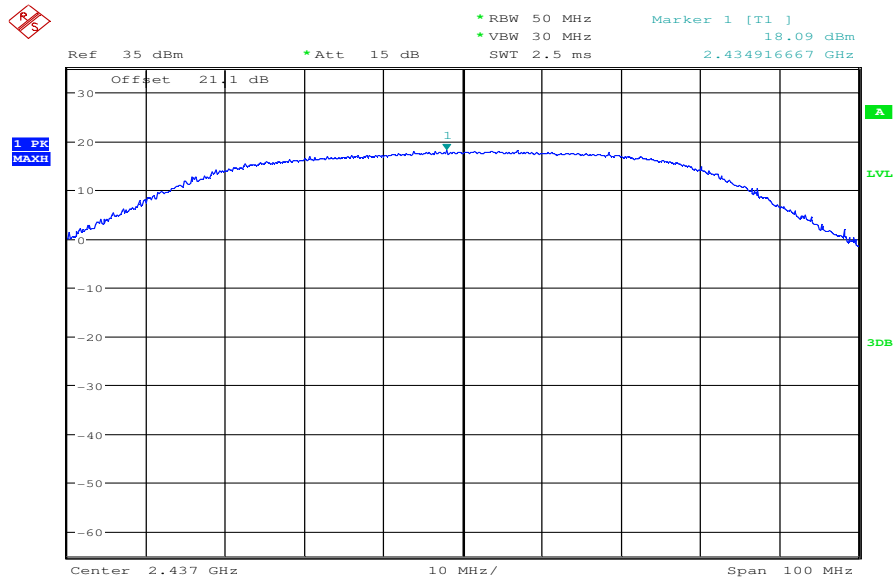

Date: 5.OCT.2010 09:03:37

Plot 13: OFDM, n – mode, MCS 0, channel 6, power index 45

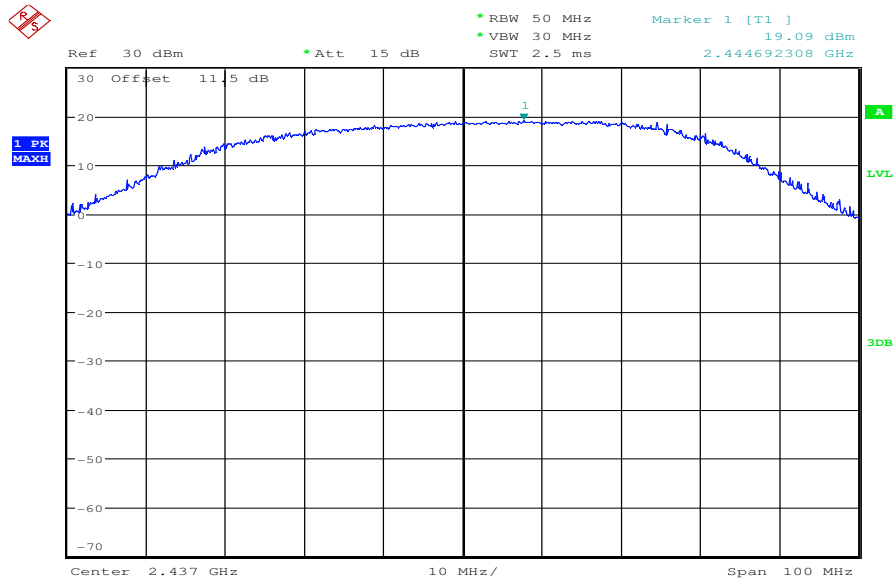

Date: 6.DEC.2010 13:17:06

Plot 14: OFDM, n – mode, MCS 1, channel 6, power index 45

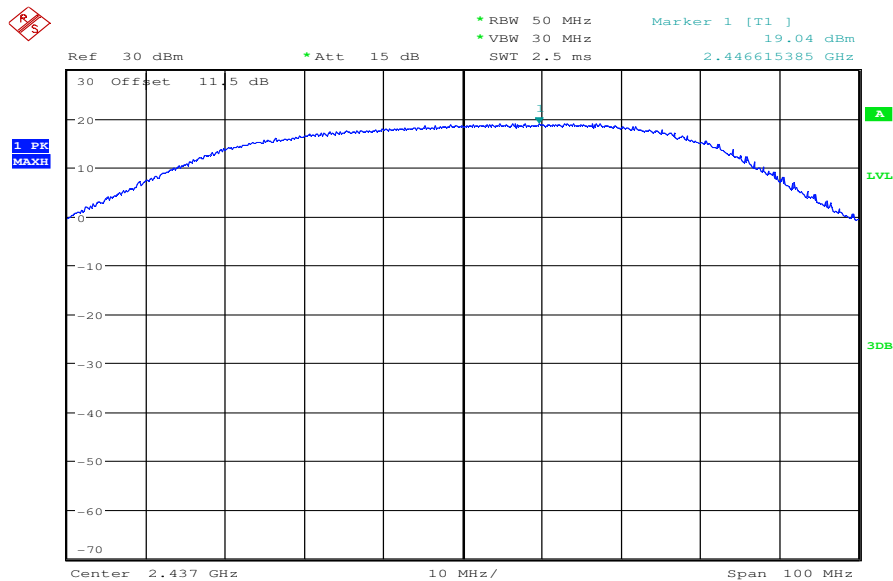

Date: 6.DEC.2010 13:17:41

Plot 15: OFDM, n – mode, MCS 2, channel 6, power index 45

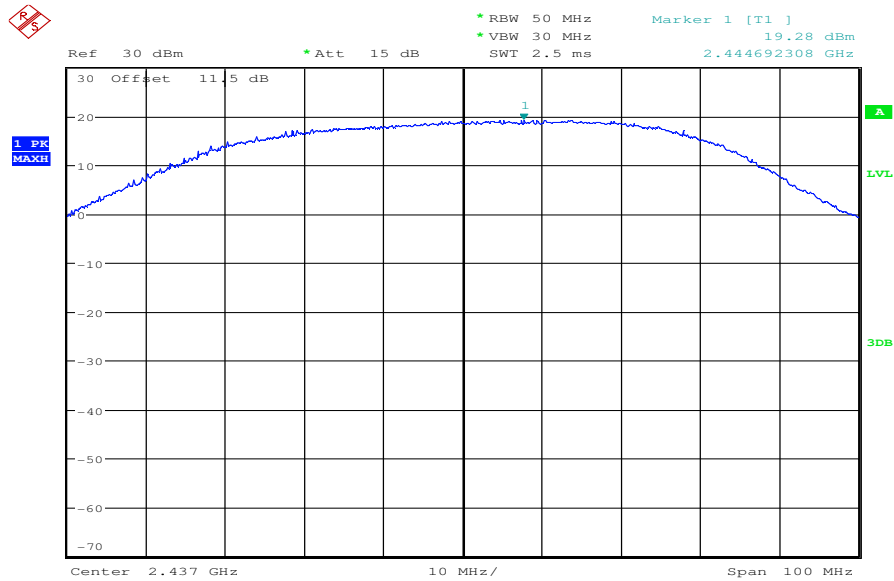

Date: 6.DEC.2010 13:18:31

Plot 16: OFDM, n – mode, MCS 3, channel 6, power index 45

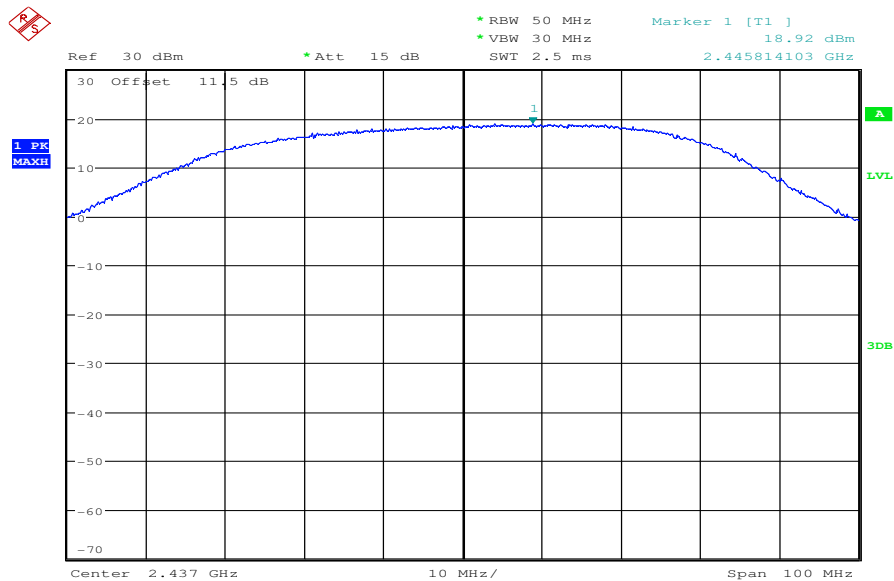

Date: 6.DEC.2010 13:19:04

Plot 17: OFDM, n – mode, MCS 4, channel 6, power index 45

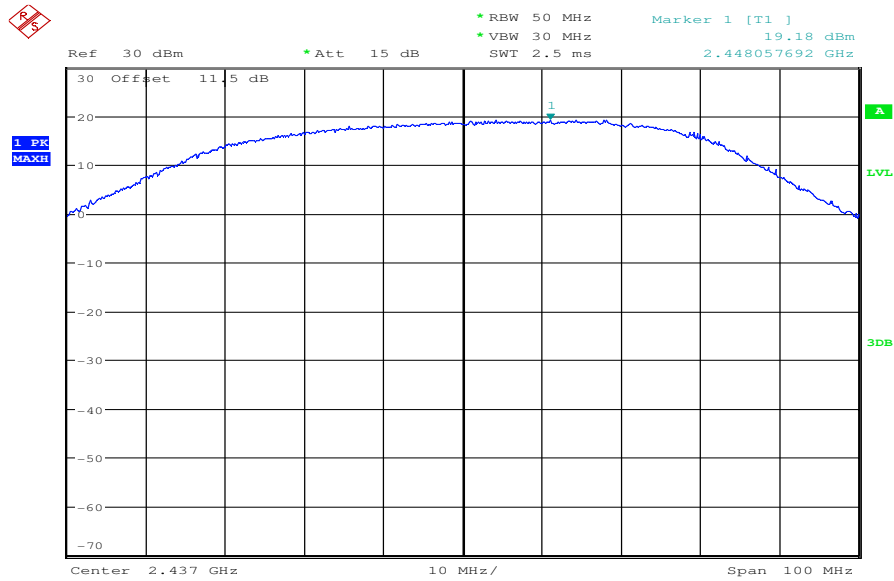

Date: 6.DEC.2010 13:19:42

Plot 18: OFDM, n – mode, MCS 5, channel 6, power index 45

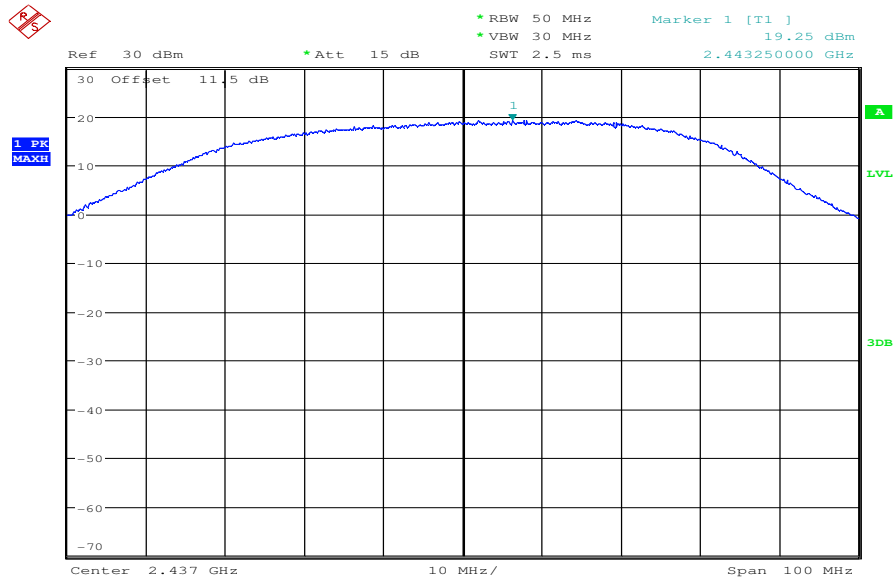

Date: 6.DEC.2010 13:20:21

Plot 19: OFDM, n – mode, MCS 6, channel 6, power index 45

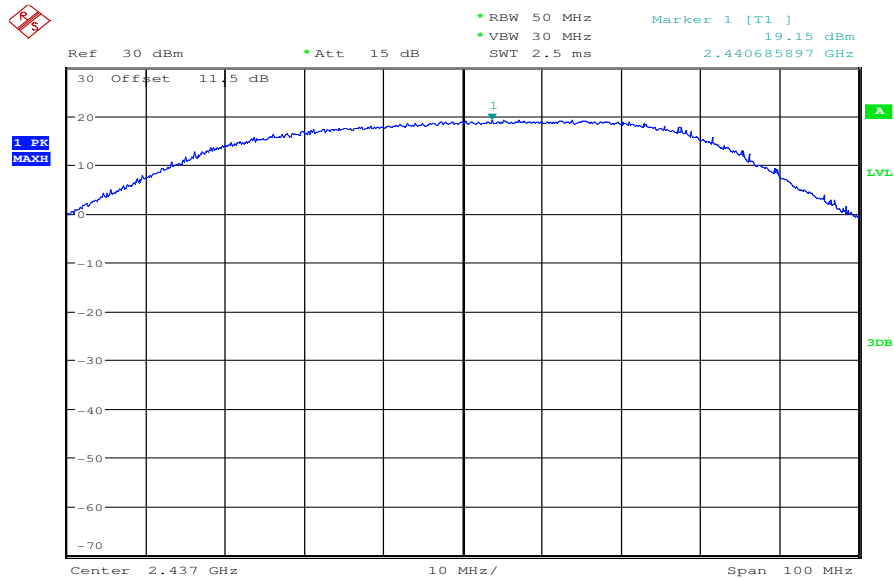

Date: 6.DEC.2010 13:21:01

Plot 20: OFDM, n – mode, MCS 7, channel 6, power index 45

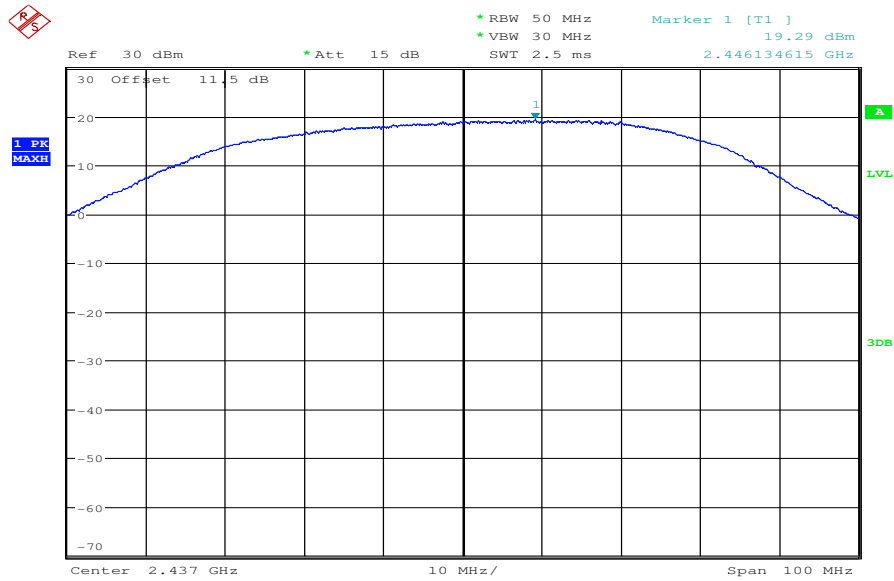

Date: 6.DEC.2010 13:22:04

8.4.1 Antenna power (conducted) & tolerance of antenna power

Measurement parameter:

Measurement parameter	
Detector:	RMS
Sweep time:	20s
Resolution bandwidth:	1 MHz
Video bandwidth:	3 MHz
Trace-Mode:	Zero span
Additional EUT parameters:	Test mode

Results: DSSS / b – mode, power index 45, 11 Mbit/s

<i>Technology / Frequency</i>	<i>Temperature / Voltage conditions</i>	<i>Output power conducted</i>
<i>DSSS – 2412 MHz</i>	T_{nom} / V_{nom}	2.86
<i>DSSS – 2442 MHz</i>	T_{nom} / V_{nom}	2.44
<i>DSSS – 2472 MHz</i>	T_{nom} / V_{nom}	2.27
<i>DSSS – 2412 MHz</i>	T_{high} / V_{low}	1.52
<i>DSSS – 2442 MHz</i>	T_{high} / V_{low}	1.03
<i>DSSS – 2472 MHz</i>	T_{high} / V_{low}	0.80
<i>DSSS – 2412 MHz</i>	T_{high} / V_{high}	1.43
<i>DSSS – 2442 MHz</i>	T_{high} / V_{high}	0.98
<i>DSSS – 2472 MHz</i>	T_{high} / V_{high}	0.90
<i>DSSS – 2412 MHz</i>	T_{low} / V_{low}	5.27
<i>DSSS – 2442 MHz</i>	T_{low} / V_{low}	4.78
<i>DSSS – 2472 MHz</i>	T_{low} / V_{low}	4.58
<i>DSSS – 2412 MHz</i>	T_{low} / V_{high}	5.19
<i>DSSS – 2442 MHz</i>	T_{low} / V_{high}	4.75
<i>DSSS – 2472 MHz</i>	T_{low} / V_{high}	4.61

Results: OFDM / g – mode, power index 17, 24 Mbit/s

<i>Technology / Frequency</i>	<i>Temperature / Voltage conditions</i>	<i>Output power conducted</i>
OFDM – 2412 MHz	T _{nom} / V _{nom}	-1.41
OFDM – 2442 MHz	T _{nom} / V _{nom}	-1.80
OFDM – 2472 MHz	T _{nom} / V _{nom}	-1.99
OFDM – 2412 MHz	T _{high} / V _{low}	-2.63
OFDM – 2442 MHz	T _{high} / V _{low}	-3.09
OFDM – 2472 MHz	T _{high} / V _{low}	-3.18
OFDM – 2412 MHz	T _{high} / V _{high}	-2.69
OFDM – 2442 MHz	T _{high} / V _{high}	-3.03
OFDM – 2472 MHz	T _{high} / V _{high}	-3.25
OFDM – 2412 MHz	T _{low} / V _{low}	1.00
OFDM – 2442 MHz	T _{low} / V _{low}	0.44
OFDM – 2472 MHz	T _{low} / V _{low}	0.62
OFDM – 2412 MHz	T _{low} / V _{high}	0.03
OFDM – 2442 MHz	T _{low} / V _{high}	0.45
OFDM – 2472 MHz	T _{low} / V _{high}	0.58

Results: OFDM / n – mode, power index 45, MCS 7

<i>Technology / Frequency</i>	<i>Temperature / Voltage conditions</i>	<i>Output power conducted</i>
OFDM – 2412 MHz	T _{nom} / V _{nom}	-1.44
OFDM – 2442 MHz	T _{nom} / V _{nom}	-1.91
OFDM – 2472 MHz	T _{nom} / V _{nom}	-2.08
OFDM – 2412 MHz	T _{high} / V _{low}	-2.67
OFDM – 2442 MHz	T _{high} / V _{low}	-3.07
OFDM – 2472 MHz	T _{high} / V _{low}	-3.22
OFDM – 2412 MHz	T _{high} / V _{high}	-2.61
OFDM – 2442 MHz	T _{high} / V _{high}	-3.12
OFDM – 2472 MHz	T _{high} / V _{high}	-3.11
OFDM – 2412 MHz	T _{low} / V _{low}	1.06
OFDM – 2442 MHz	T _{low} / V _{low}	0.51
OFDM – 2472 MHz	T _{low} / V _{low}	0.64
OFDM – 2412 MHz	T _{low} / V _{high}	1.10
OFDM – 2442 MHz	T _{low} / V _{high}	0.48
OFDM – 2472 MHz	T _{low} / V _{high}	0.66

All detected values are within +20 % and -80 % of the rated power values of each technology!

Limit:

Limit	max. 10 mW/MHz / 10 dBm/MHz
--------------	--------------------------------

Result: The result of the measurement is passed.

8.4.2 Frequency tolerance

Measurement parameter:

Measurement parameter	
Detector:	Peak
Sweep time:	Auto
Resolution bandwidth:	1 kHz
Video bandwidth:	1 kHz
Trace-Mode:	Max Hold
Additional EUT parameters:	Test mode Power index 45

The results are valid for all technologies – DSSS and OFDM mode! Both modes use the same oscillator!

Results (normal temperature / normal voltage):

	<i>lowest channel</i> $f_{TX}=2412$ MHz	<i>mid channel</i> $f_{TX}=2442$ MHz	<i>highest channel</i> $f_{TX}=2472$ MHz
<i>Frequency offset [kHz]</i>	-3.2	-2.4	-0.8
<i>Offset [ppm] related to f_{TX}</i>	-1.3	-1.0	-0.3

Results (high temperature / low voltage):

	<i>lowest channel</i> $f_{TX}=2412$ MHz	<i>mid channel</i> $f_{TX}=2442$ MHz	<i>highest channel</i> $f_{TX}=2472$ MHz
<i>Frequency offset [kHz]</i>	-9.9	-9.5	-9.8
<i>Offset [ppm] related to f_{TX}</i>	-4.1	-3.9	-4.0

Results (high temperature / high voltage):

	<i>lowest channel</i> $f_{TX}=2412$ MHz	<i>mid channel</i> $f_{TX}=2442$ MHz	<i>highest channel</i> $f_{TX}=2472$ MHz
<i>Frequency offset [kHz]</i>	-9.6	-9.5	-9.4
<i>Offset [ppm] related to f_{TX}</i>	-4.0	-3.9	-3.8

Results (low temperature / low voltage):

	<i>lowest channel</i> $f_{TX}=2412$ MHz	<i>mid channel</i> $f_{TX}=2442$ MHz	<i>highest channel</i> $f_{TX}=2472$ MHz
<i>Frequency offset [kHz]</i>	13.5	14.1	14.6
<i>Offset [ppm] related to f_{TX}</i>	5.6	5.8	5.9

Results (low temperature / high voltage):

	<i>lowest channel</i> $f_{TX}=2412$ MHz	<i>mid channel</i> $f_{TX}=2442$ MHz	<i>highest channel</i> $f_{TX}=2472$ MHz
<i>Frequency offset [kHz]</i>	13.5	13.9	14.4
<i>Offset [ppm] related to f_{TX}</i>	5.6	5.7	5.8

Limit & Verdict:

Limit	< 50ppm
--------------	---------

Result: [The result of the measurement is passed.](#)

8.4.3 Modulation method

DSSS technology with BPSK and QPSK modulation.

OFDM technology with BPSK, QPSK, 16 QAM and 64 QAM modulation.

Result: The result of the measurement is passed.

8.4.4 Spurious emission intensity - conducted

Measurement parameter:

Measurement parameter	
Detector:	Positive peak
Sweep time:	1s / 10s / 12s
Resolution bandwidth:	f <= 1GHz : 1 MHz f > 1GHz : 1 MHz
Video bandwidth:	f <= 1GHz : 10 kHz f > 1GHz : 10 kHz
Span:	See limit!
Trace-Mode:	Max Hold
Additional EUT parameters:	Test mode (modulated carrier) DSSS used OFDM used Max power

Results:

DSSS / b – mode	lowest channel f _{TX} =2412 MHz		mid channel f _{TX} =2442 MHz		highest channel f _{TX} =2472 MHz	
	F [MHz]	Level [dBm]	F [MHz]	Level [dBm]	F [MHz]	Level [dBm]
Found peaks:	No critical peaks found (see plots).					

OFDM / g – mode	lowest channel f _{TX} =2412 MHz		mid channel f _{TX} =2442 MHz		highest channel f _{TX} =2472 MHz	
	F [MHz]	Level [dBm]	F [MHz]	Level [dBm]	F [MHz]	Level [dBm]
Found peaks:	No critical peaks found (see plots).					

OFDM / n – mode	lowest channel f _{TX} =2412 MHz		mid channel f _{TX} =2442 MHz		highest channel f _{TX} =2472 MHz	
	F [MHz]	Level [dBm]	F [MHz]	Level [dBm]	F [MHz]	Level [dBm]
Found peaks:	No critical peaks found (see plots).					

Limit:

Limit	30 MHz <= f < 2387 MHz: 2.5uW (-26 dBm) 2387 MHz <= f < 2400 MHz: 25uW (-16 dBm) 2483.5 MHz < f <= 2496.5 MHz: 25uW (-16 dBm) 2496.5 MHz > f and 12500 MHz < f : 2.5uW (-26 dBm)
--------------	---

Result: The result of the measurement is passed.

Plots: DSSS / b – mode

Plot 1: TX mode, lowest channel, 30 MHz to 1 GHz

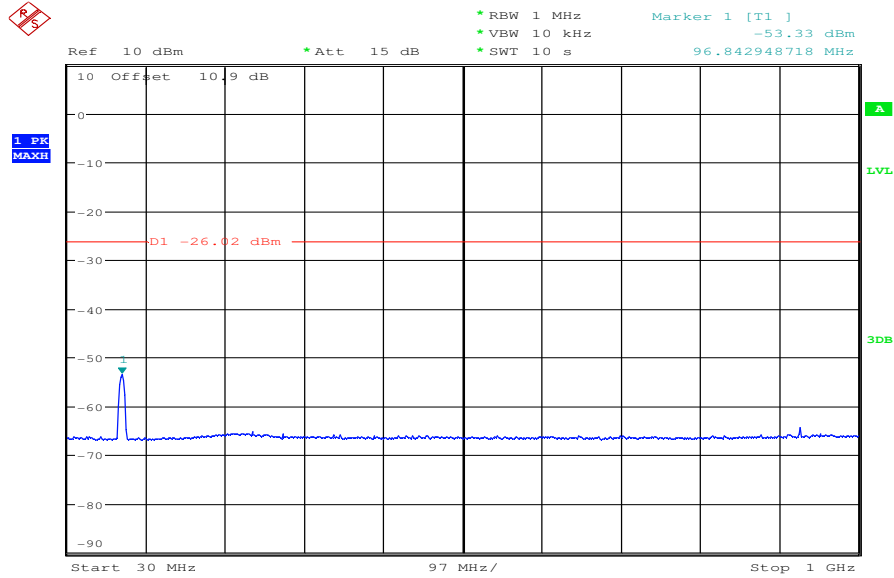

Date: 21.FEB.2011 08:08:48

Plot 2: TX mode, lowest channel, 1 GHz to 2387 MHz

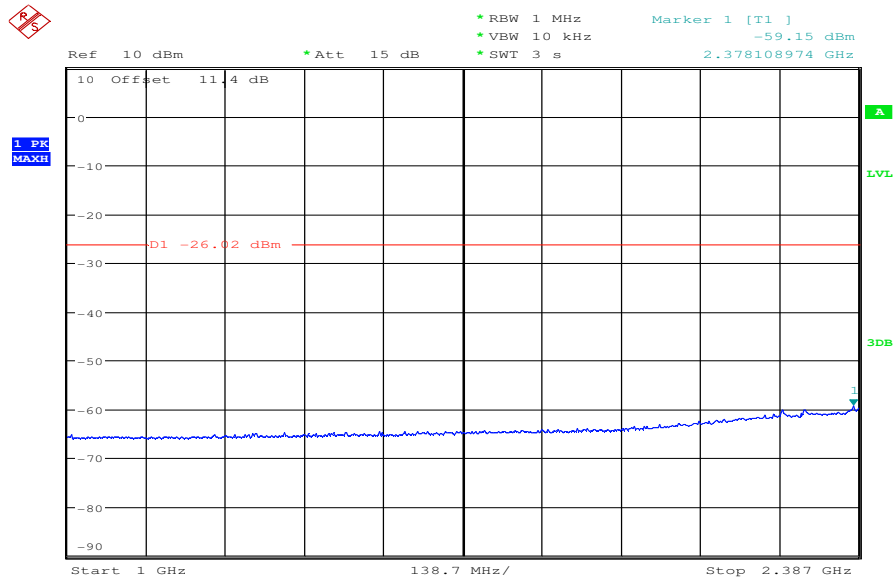

Date: 21.FEB.2011 08:16:49

Plot 3: TX mode, lowest channel, 2387 MHz to 2400 MHz

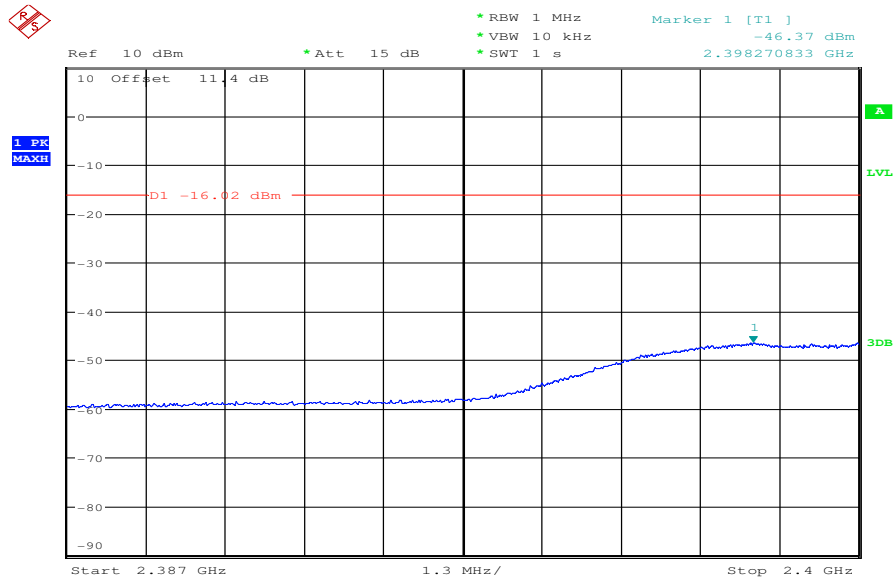

Date: 21.FEB.2011 08:45:08

Plot 4: TX mode, lowest channel, 2483.5 MHz to 2496.5 MHz

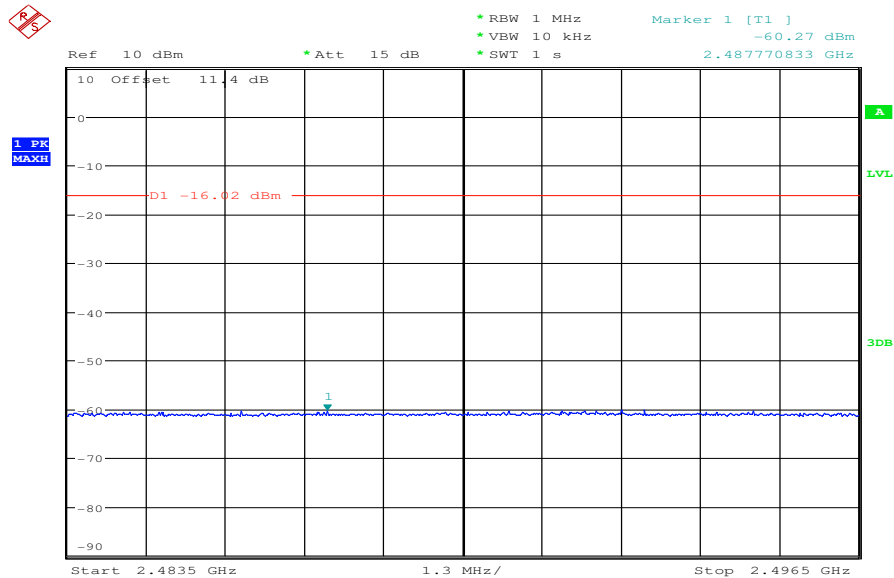

Date: 21.FEB.2011 09:15:20

Plot 5: TX mode, lowest channel, 2496.5 MHz to 12500 MHz

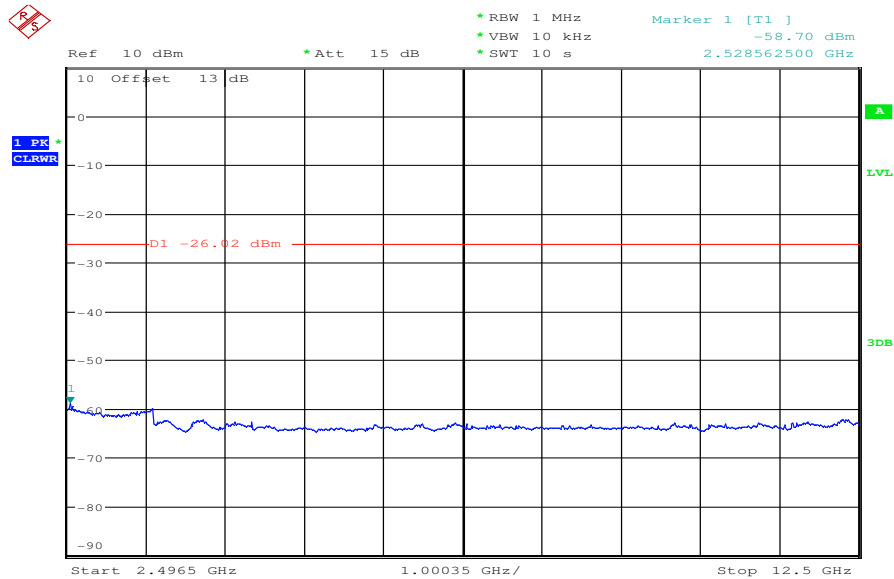

Date: 21.FEB.2011 09:24:04

Plot 6: TX mode, middle channel, 30 MHz to 1 GHz

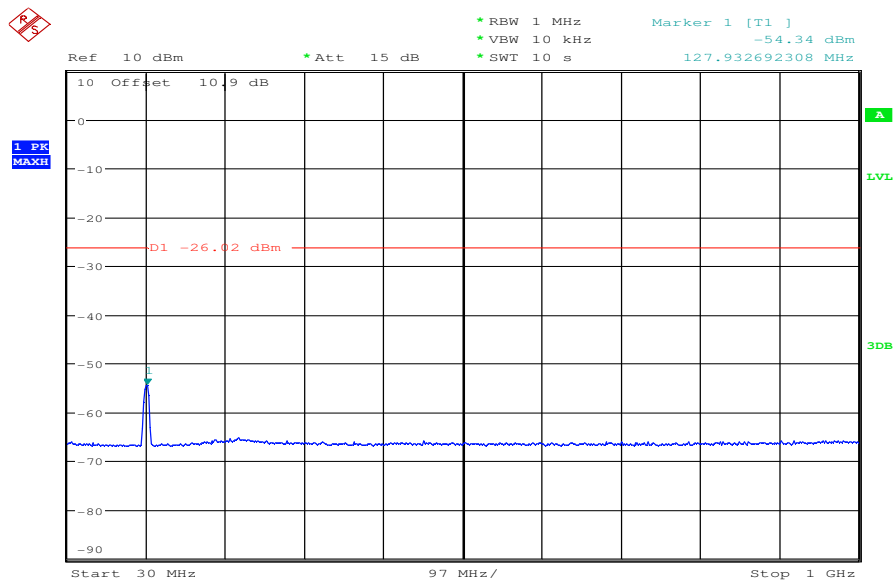

Date: 21.FEB.2011 08:09:34

Plot 7: TX mode, middle channel, 1 GHz to 2387 MHz

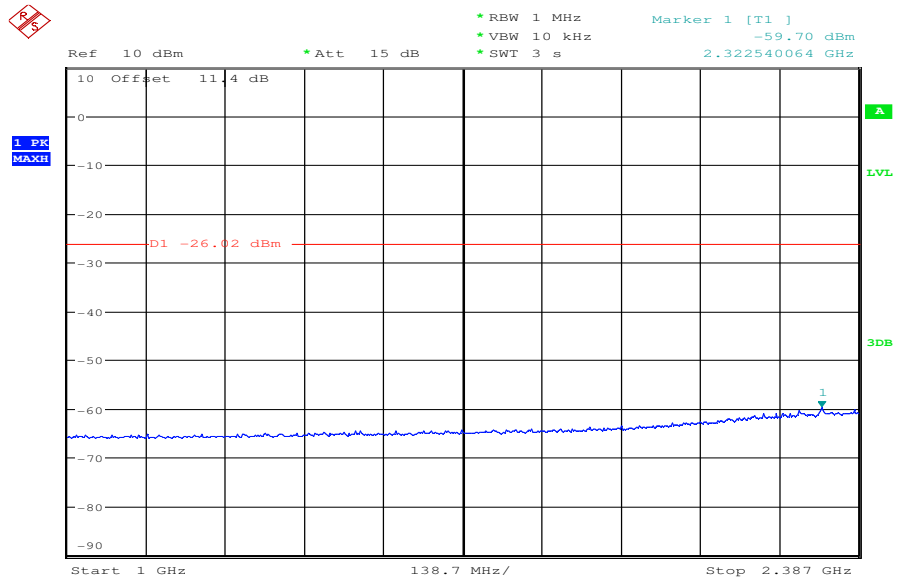

Date: 21.FEB.2011 08:17:34

Plot 8: TX mode, middle channel, 2387 MHz to 2400 MHz

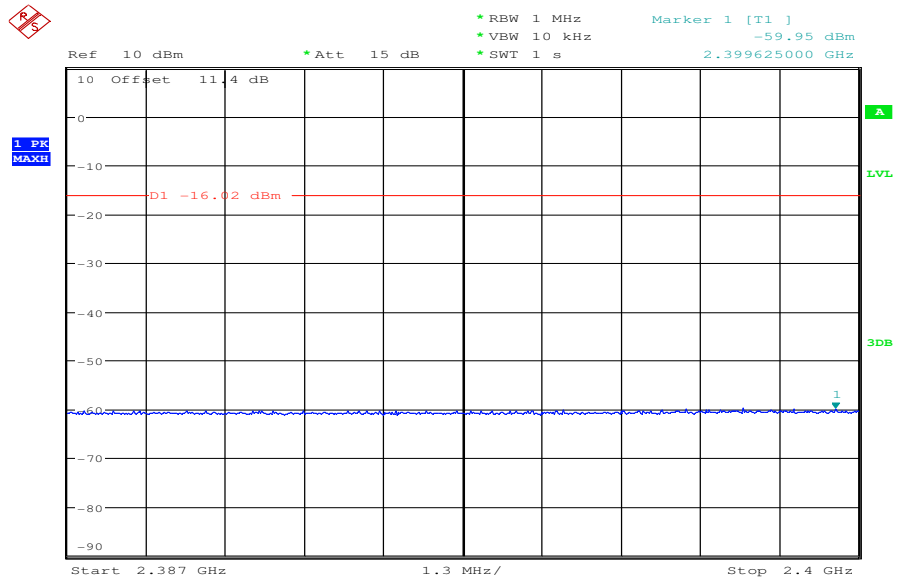

Date: 21.FEB.2011 08:45:55

Plot 9: TX mode, middle channel, 2483.5 MHz to 2496.5 MHz

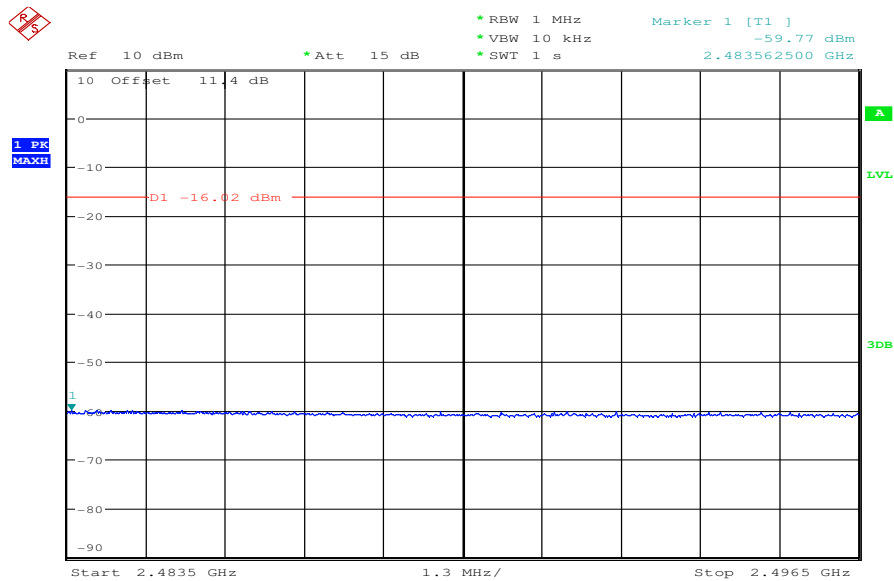

Date: 21.FEB.2011 09:16:30

Plot 10: TX mode, middle channel, 2496.5 MHz to 12500 MHz

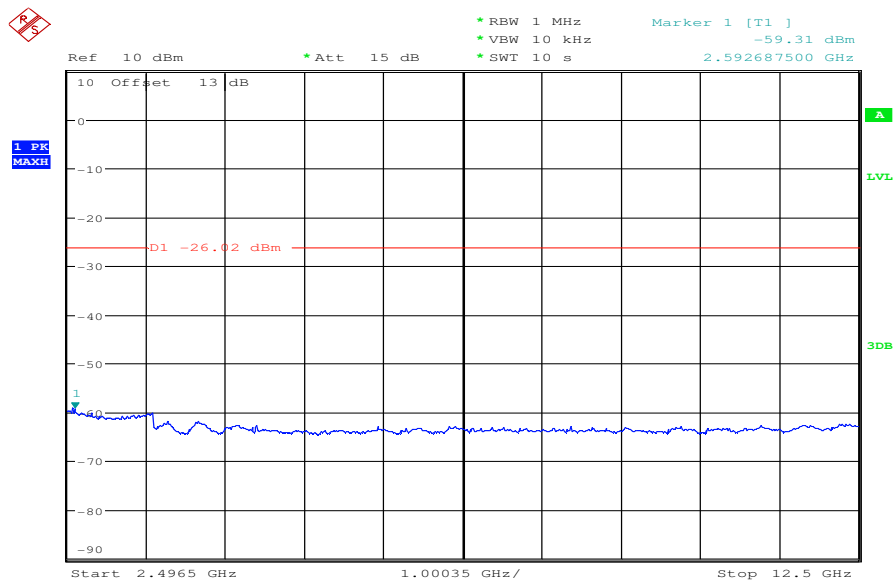

Date: 21.FEB.2011 09:24:40

Plot 11: TX mode, highest channel, 30 MHz to 1 GHz

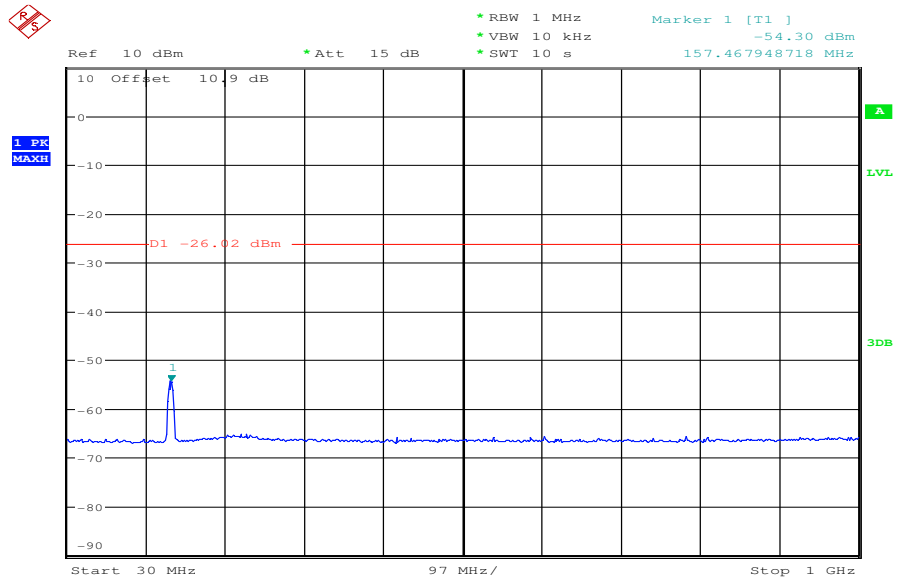

Date: 21.FEB.2011 08:10:13

Plot 12: TX mode, highest channel, 1 GHz to 2387 MHz

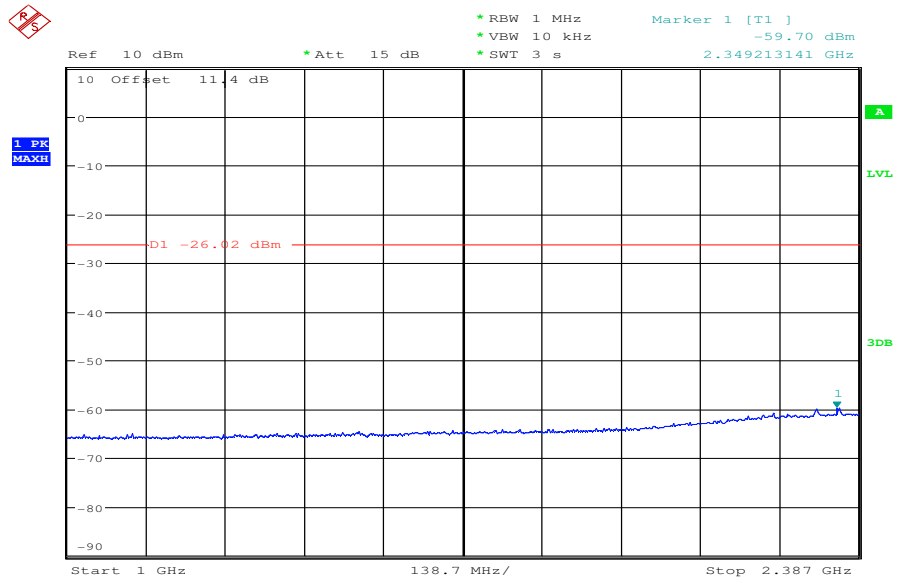

Date: 21.FEB.2011 08:18:26

Plot 13: TX mode, highest channel, 2387 MHz to 2400 MHz

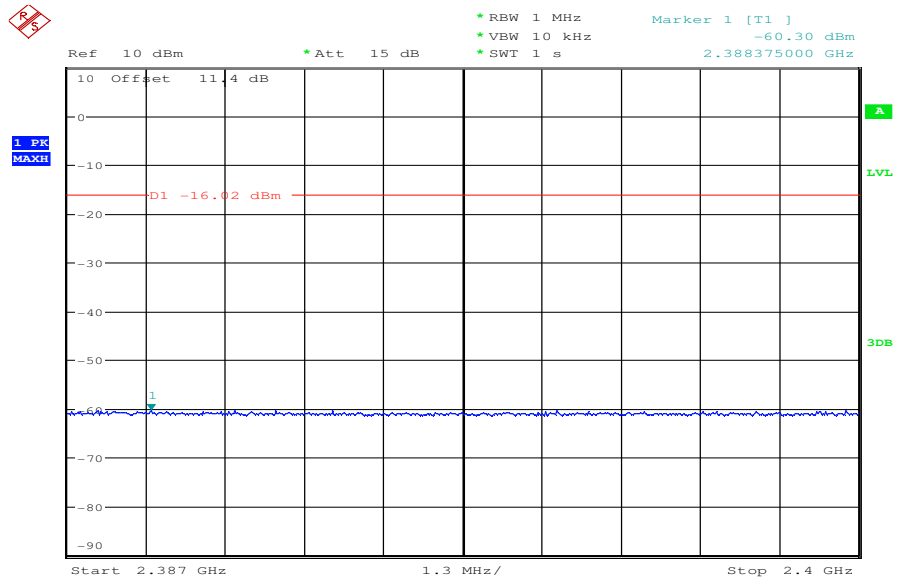

Date: 21.FEB.2011 08:46:55

Plot 14: TX mode, highest channel, 2483.5 MHz to 2496.5 MHz

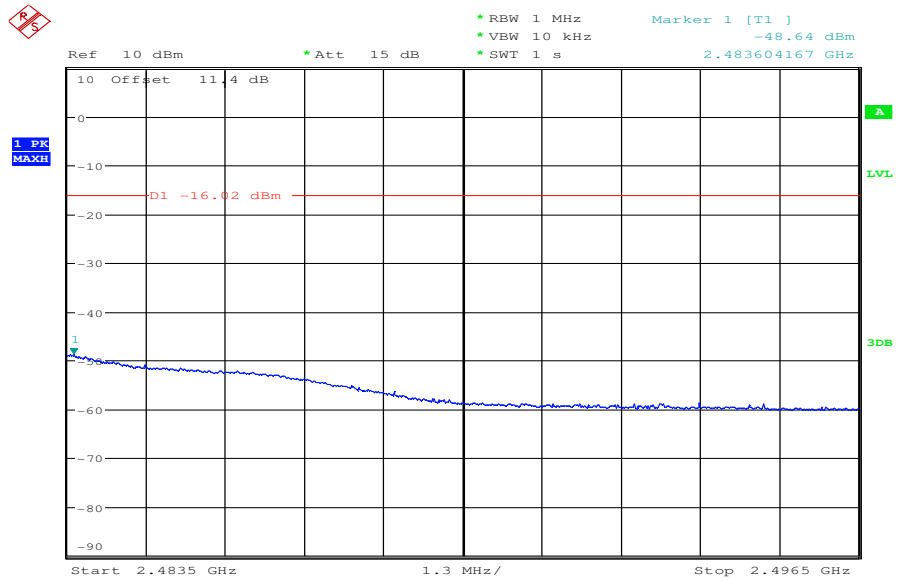

Date: 21.FEB.2011 09:17:08

Plot 15: TX mode, highest channel, 2496.5 MHz to 12500 MHz

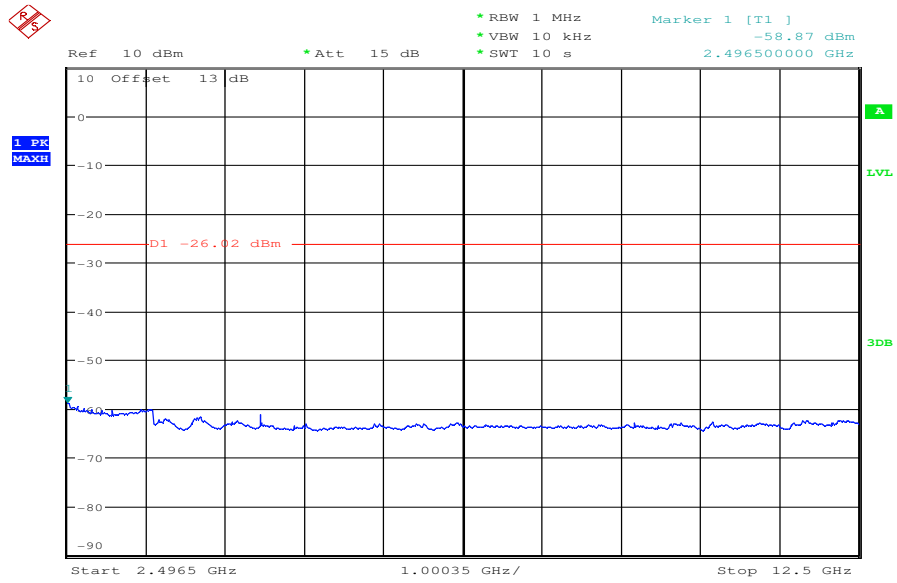

Date: 21.FEB.2011 09:25:28

Plots: OFDM / g – mode

Plot 1: TX mode, lowest channel, 30 MHz to 1 GHz

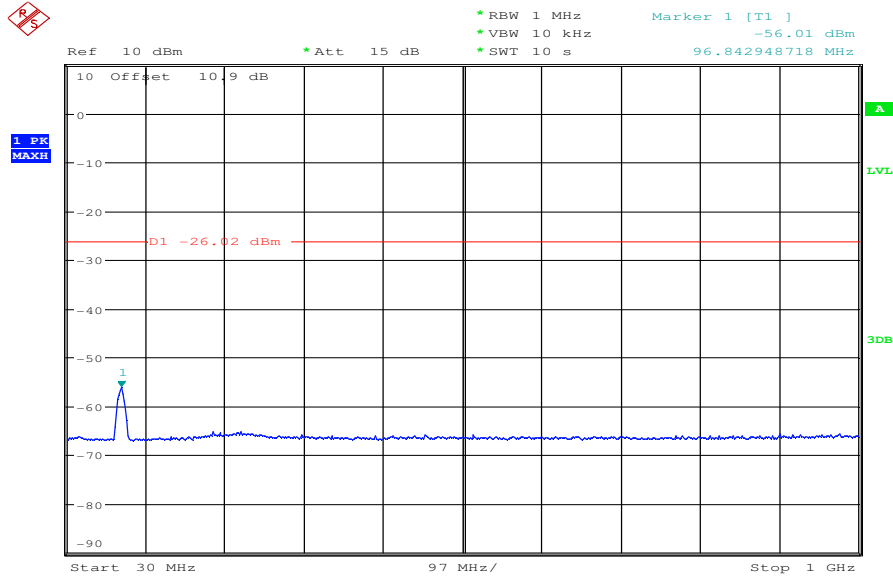

Date: 21.FEB.2011 08:11:09

Plot 2: TX mode, lowest channel, 1 GHz to 2387 MHz

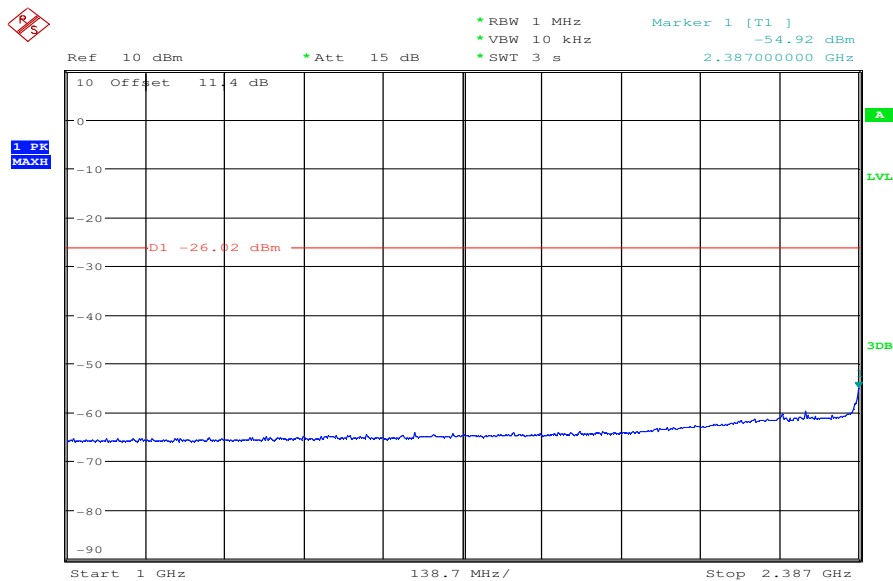

Date: 21.FEB.2011 08:19:20

Plot 3: TX mode, lowest channel, 2387 MHz to 2400 MHz

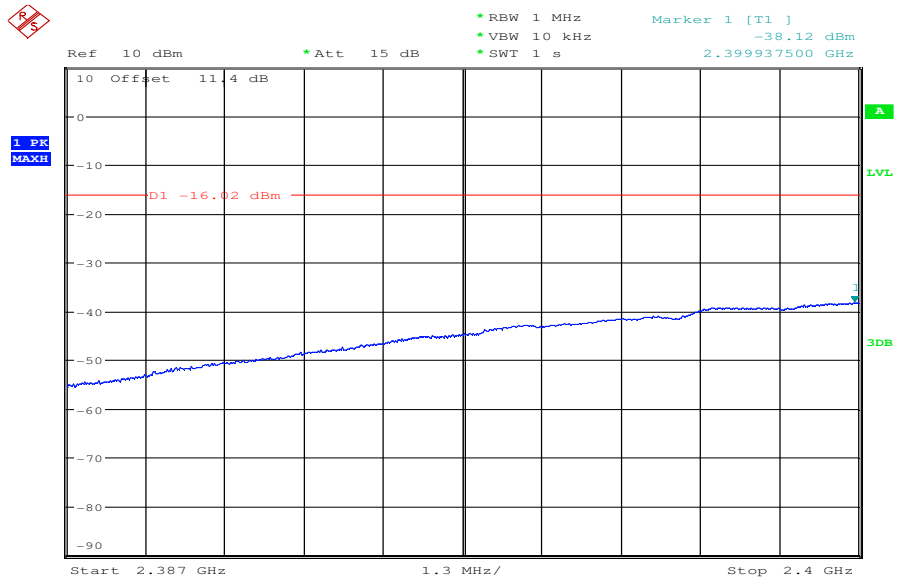

Date: 21.FEB.2011 08:47:54

Plot 4: TX mode, lowest channel, 2483.5 MHz to 2496.5 MHz

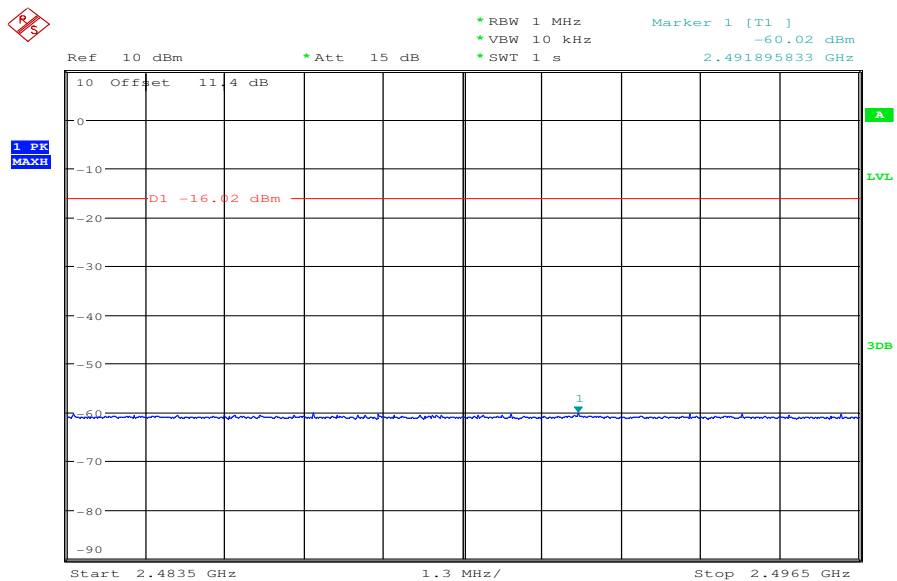

Date: 21.FEB.2011 09:18:07

Plot 5: TX mode, lowest channel, 2496.5 MHz to 12500 MHz

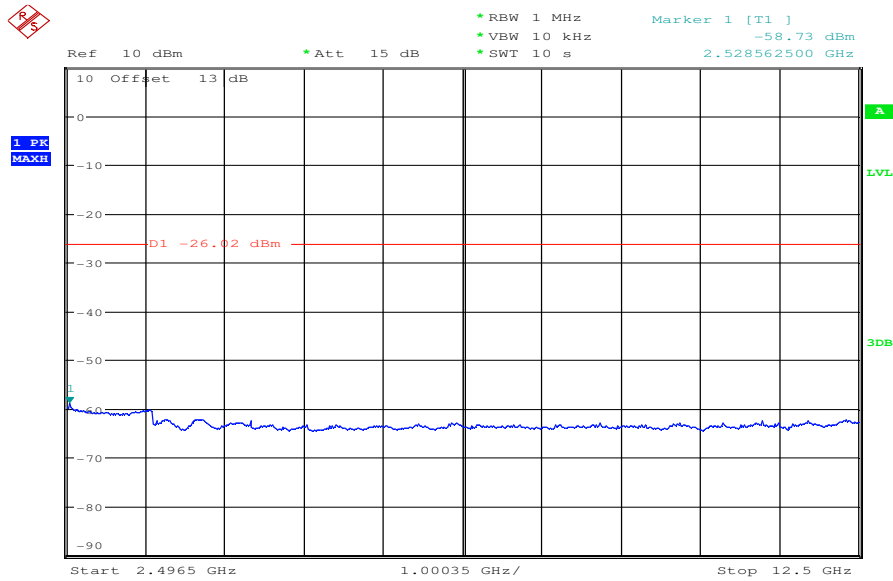

Date: 21.FEB.2011 09:26:05

Plot 6: TX mode, middle channel, 30 MHz to 1 GHz

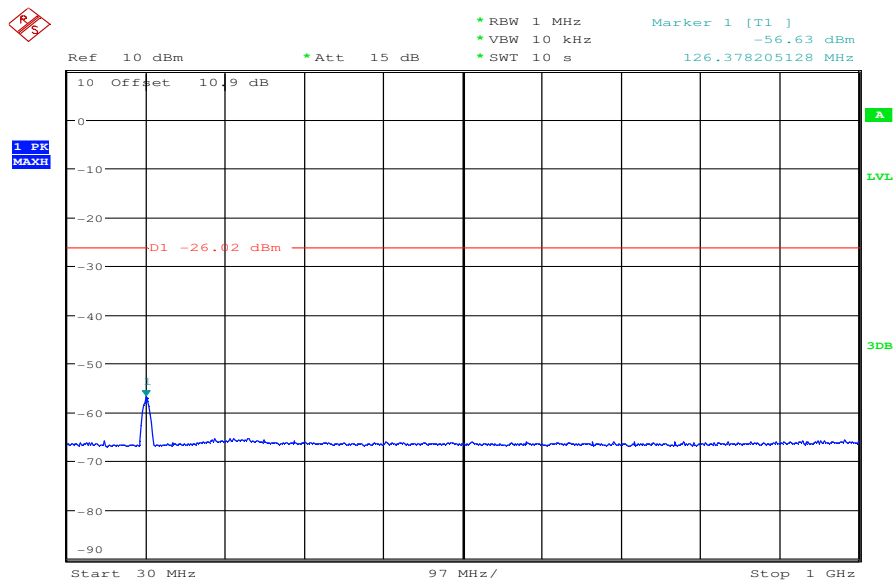

Date: 21.FEB.2011 08:11:56

Plot 7: TX mode, middle channel, 1 GHz to 2387 MHz

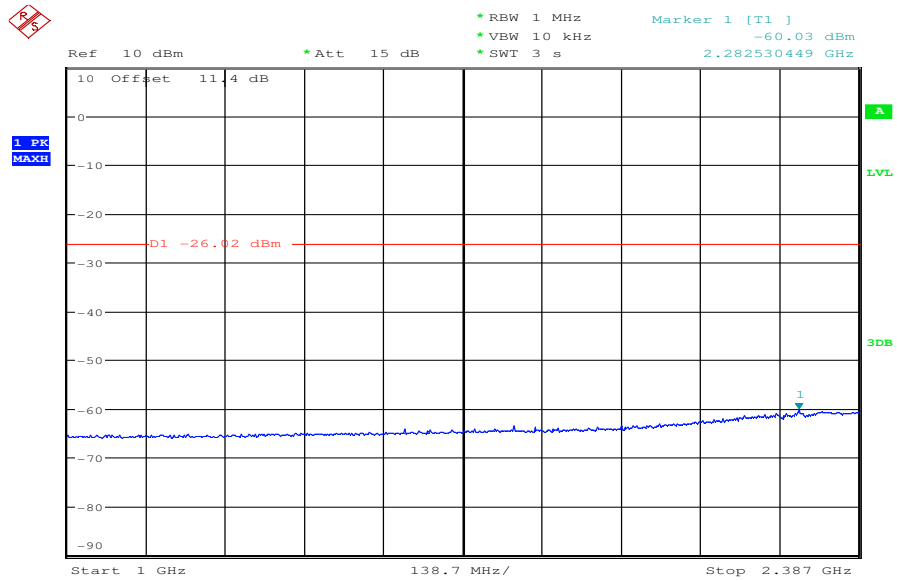

Date: 21.FEB.2011 08:20:32

Plot 8: TX mode, middle channel, 2387 MHz to 2400 MHz

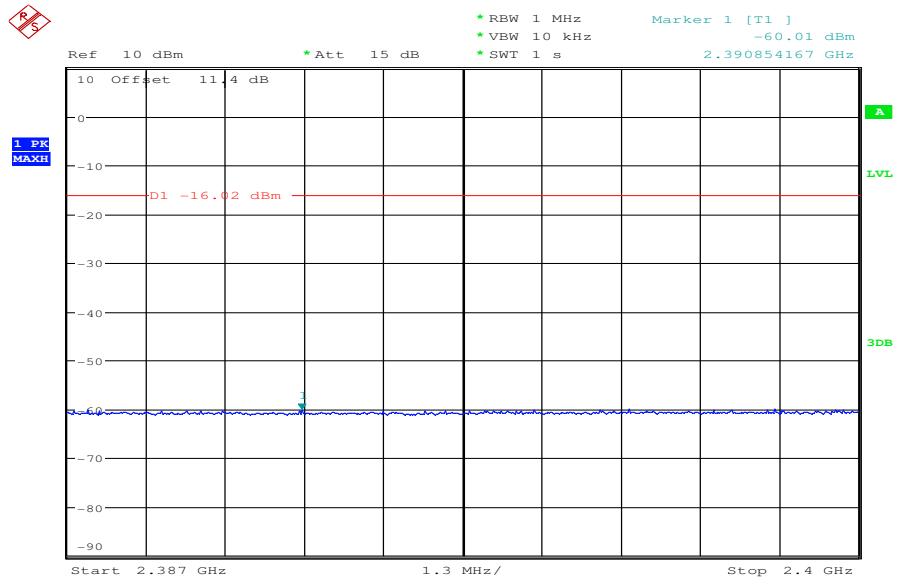

Date: 21.FEB.2011 08:48:38

Plot 9: TX mode, middle channel, 2483.5 MHz to 2496.5 MHz

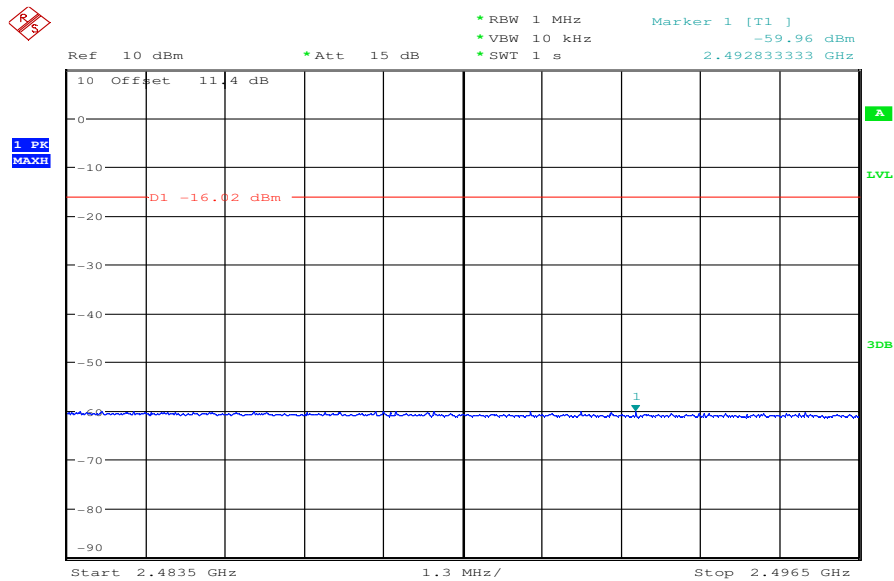

Date: 21.FEB.2011 09:18:51

Plot 10: TX mode, middle channel, 2496.5 MHz to 12500 MHz

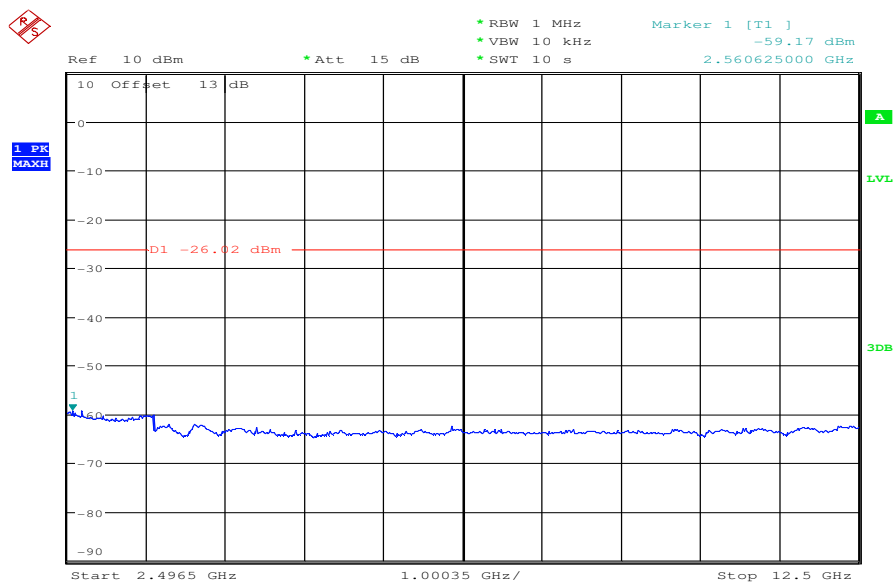

Date: 21.FEB.2011 09:26:46

Plot 11: TX mode, highest channel, 30 MHz to 1 GHz

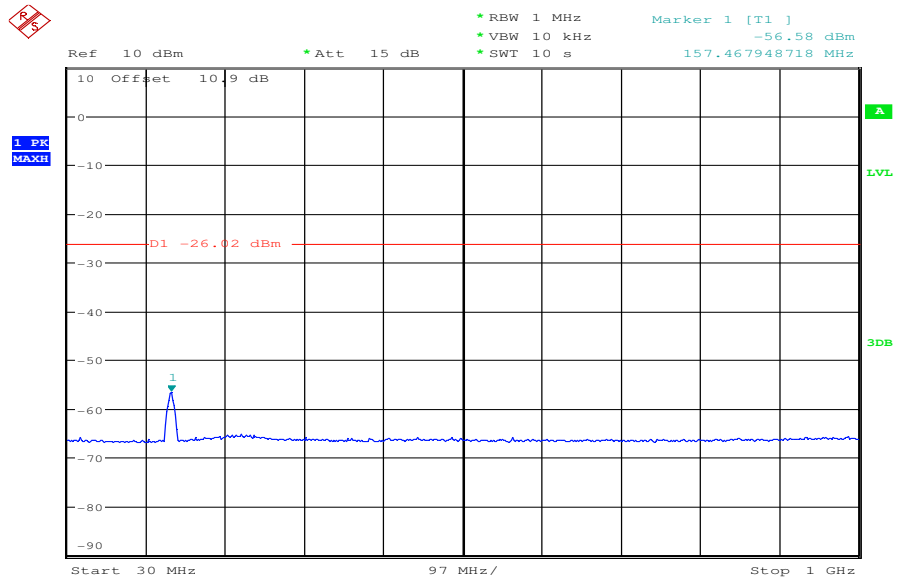

Date: 21.FEB.2011 08:12:53

Plot 12: TX mode, highest channel, 1 GHz to 2387 MHz

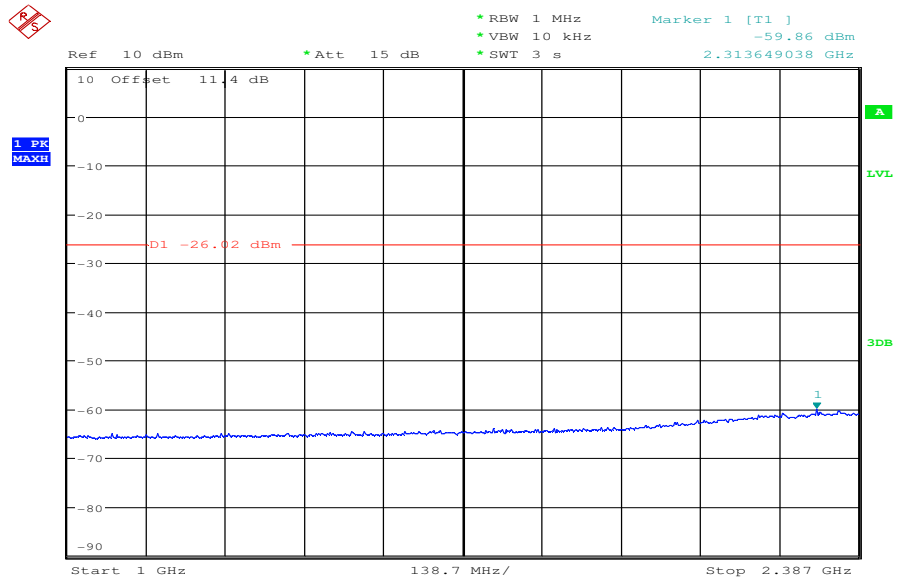

Date: 21.FEB.2011 08:39:05

Plot 13: TX mode, highest channel, 2387 MHz to 2400 MHz

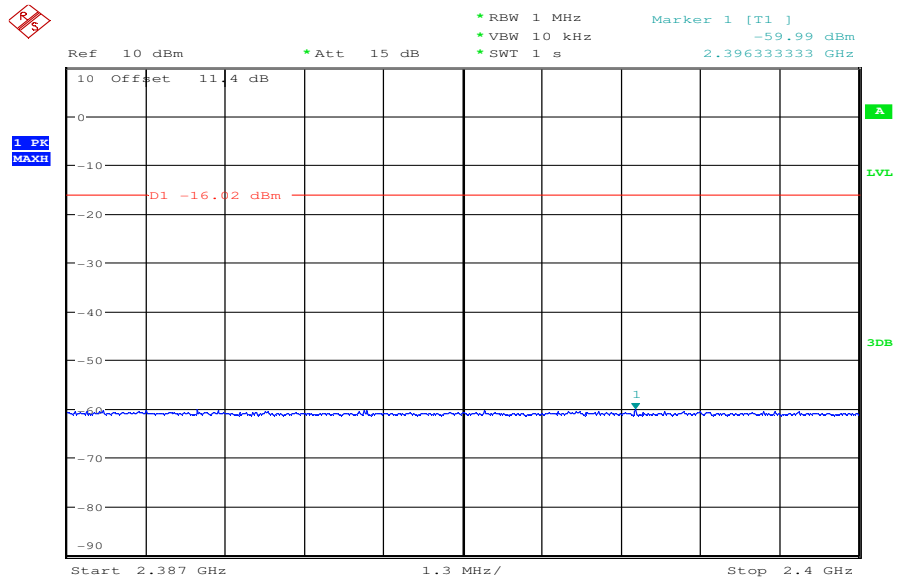

Date: 21.FEB.2011 08:49:27

Plot 14: TX mode, highest channel, 2483.5 MHz to 2496.5 MHz

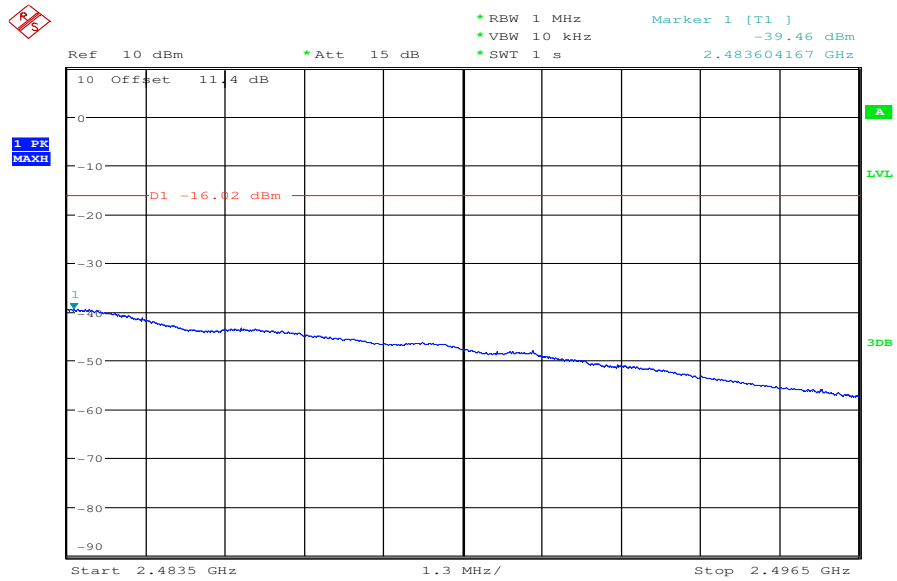

Date: 21.FEB.2011 09:19:44

Plot 15: TX mode, highest channel, 2496.5 MHz to 12500 MHz

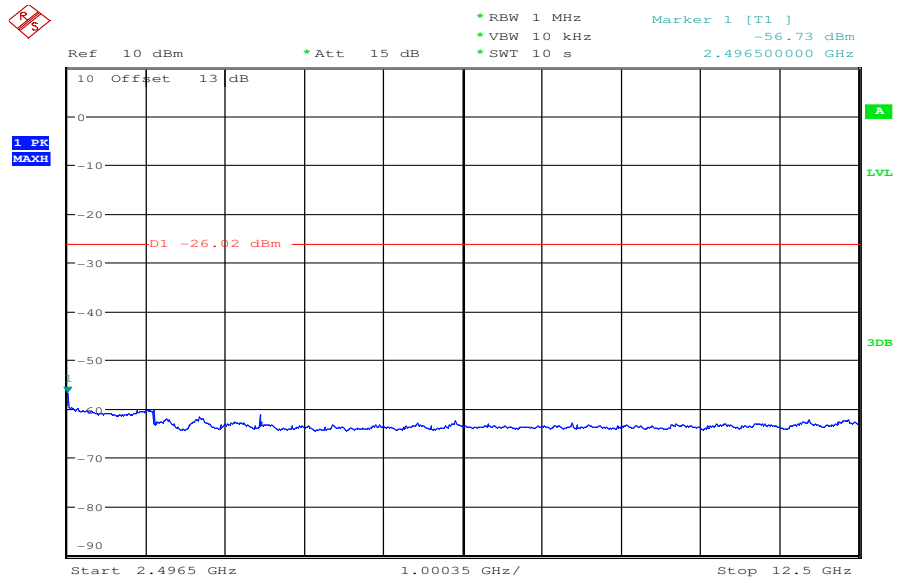

Date: 21.FEB.2011 09:27:35

Plots: OFDM / n – mode

Plot 1: TX mode, lowest channel, 30 MHz to 1 GHz

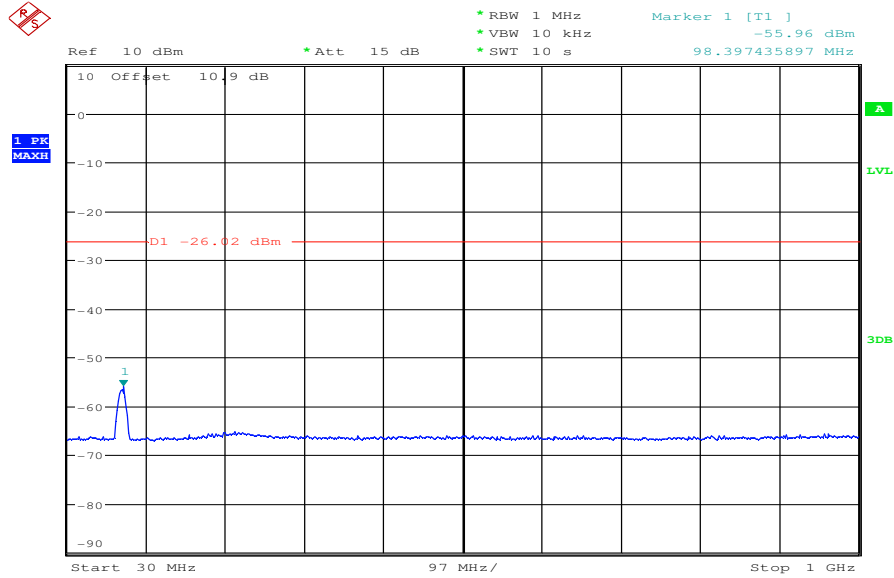

Date: 21.FEB.2011 08:13:33

Plot 2: TX mode, lowest channel, 1 GHz to 2387 MHz

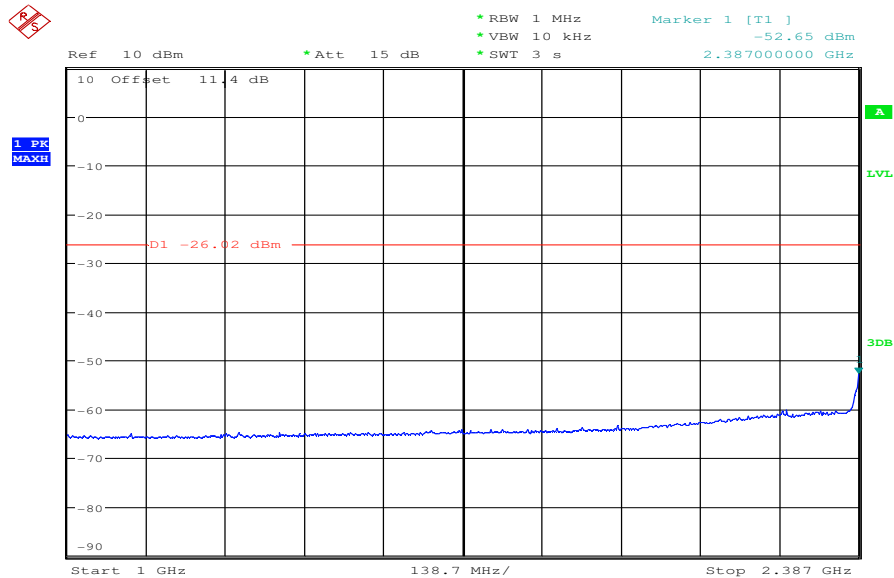

Date: 21.FEB.2011 08:40:13

Plot 3: TX mode, lowest channel, 2387 MHz to 2400 MHz

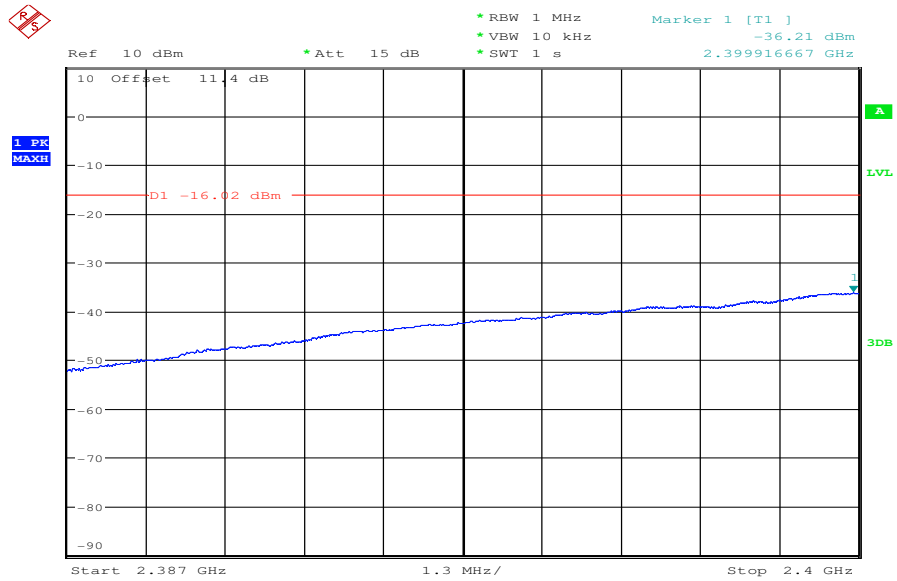

Date: 21.FEB.2011 08:50:30

Plot 4: TX mode, lowest channel, 2483.5 MHz to 2496.5 MHz

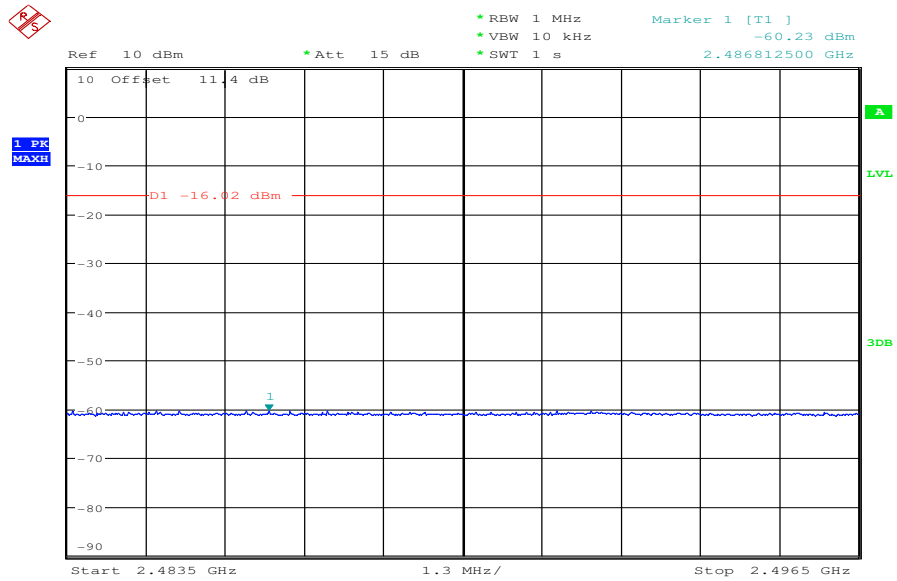

Date: 21.FEB.2011 09:20:52

Plot 5: TX mode, lowest channel, 2496.5 MHz to 12500 MHz

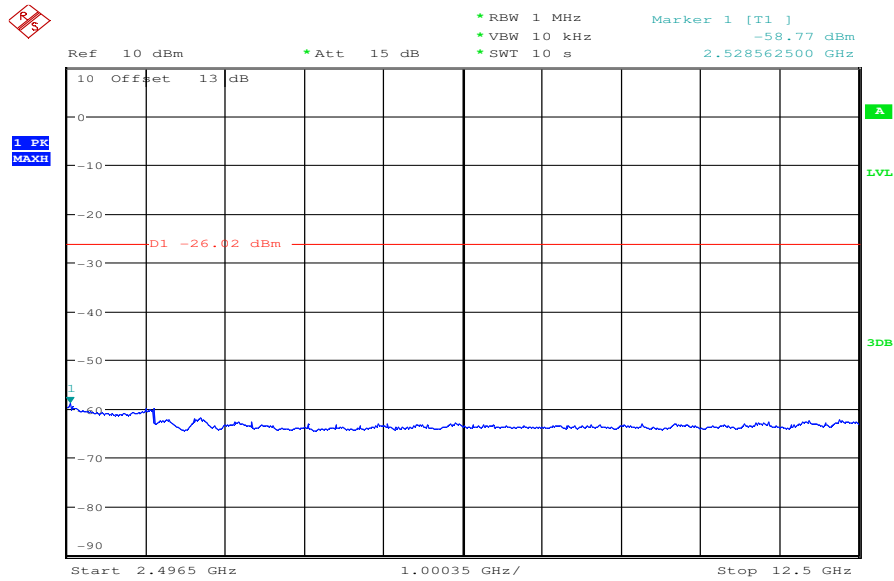

Date: 21.FEB.2011 09:28:12

Plot 6: TX mode, middle channel, 30 MHz to 1 GHz

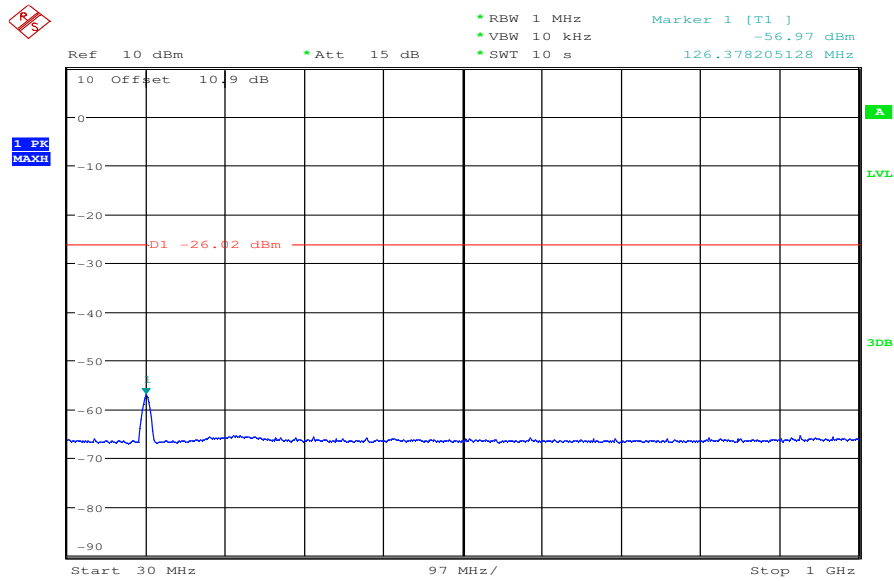

Date: 21.FEB.2011 08:14:32

Plot 7: TX mode, middle channel, 1 GHz to 2387 MHz

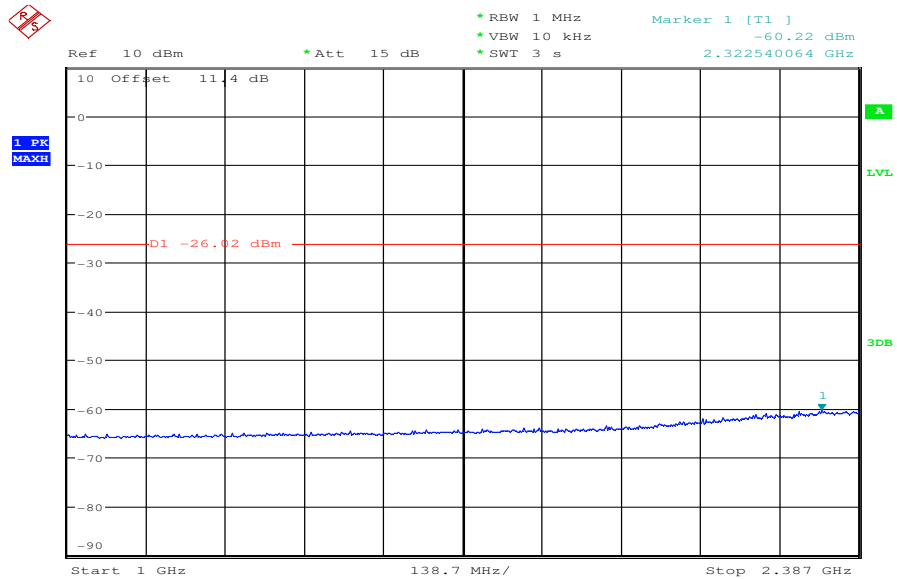

Date: 21.FEB.2011 08:41:13

Plot 8: TX mode, middle channel, 2387 MHz to 2400 MHz

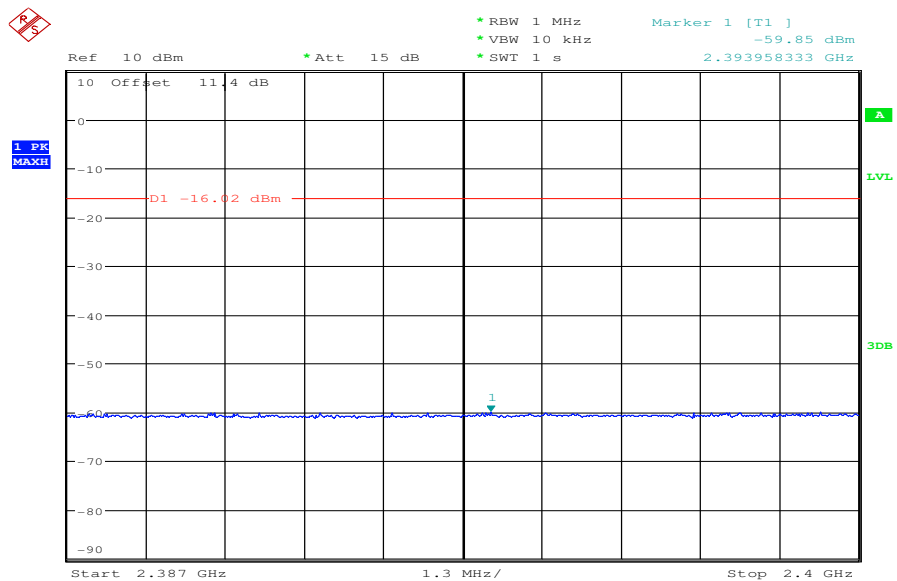

Date: 21.FEB.2011 08:51:16

Plot 9: TX mode, middle channel, 2483.5 MHz to 2496.5 MHz

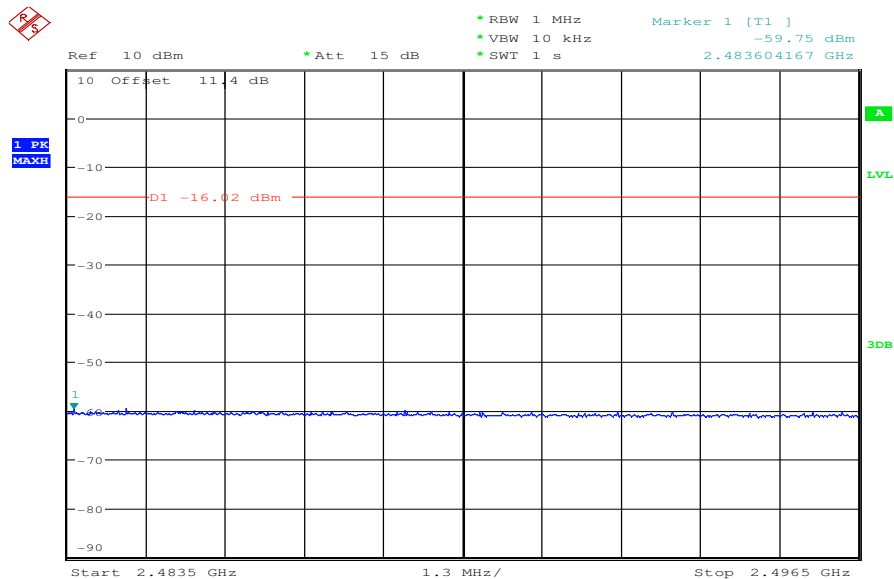

Date: 21.FEB.2011 09:21:51

Plot 10: TX mode, middle channel, 2496.5 MHz to 12500 MHz

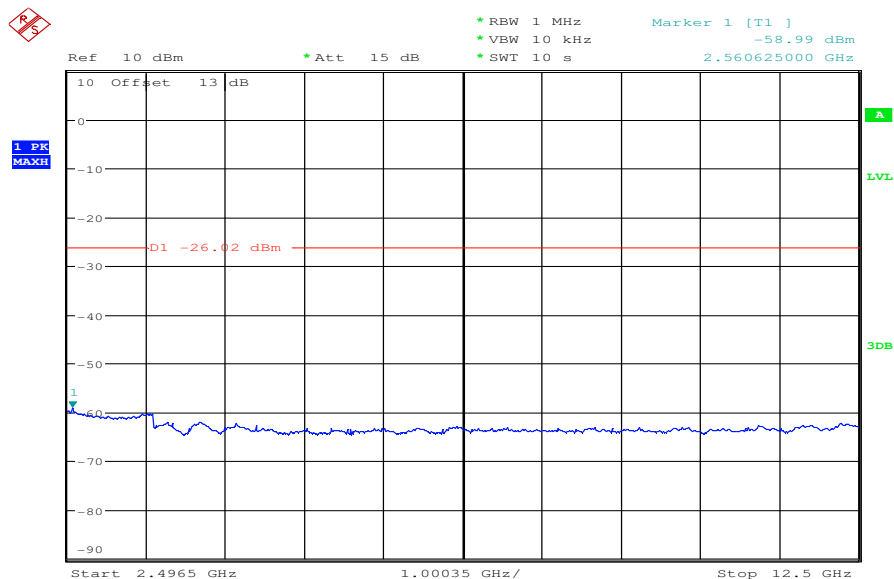

Date: 21.FEB.2011 09:28:53

Plot 11: TX mode, highest channel, 30 MHz to 1 GHz

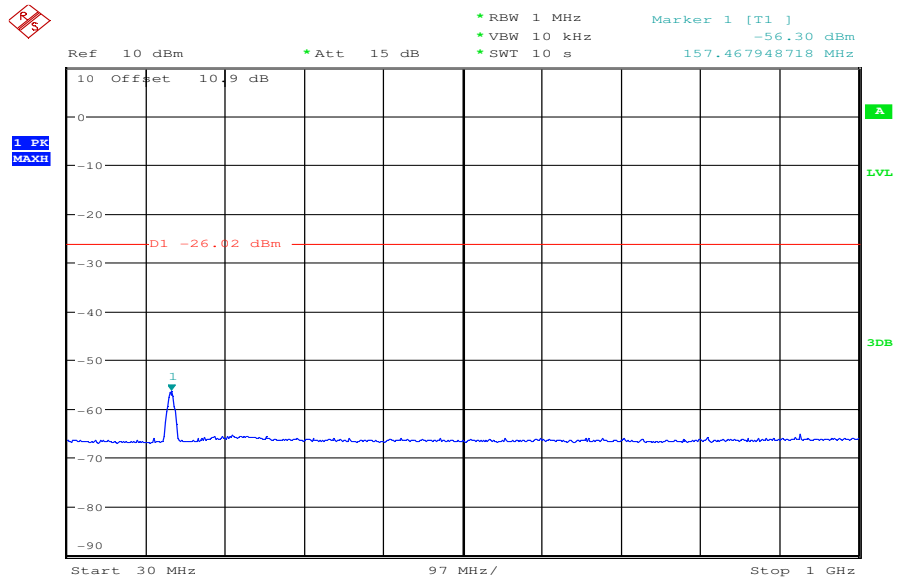

Date: 21.FEB.2011 08:15:12

Plot 12: TX mode, highest channel, 1 GHz to 2387 MHz

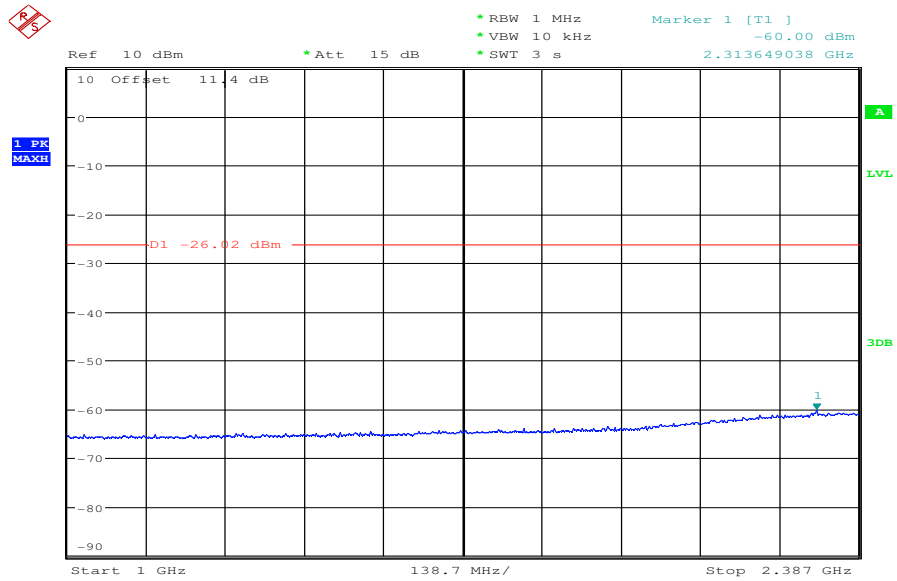

Date: 21.FEB.2011 08:42:04

Plot 13: TX mode, highest channel, 2387 MHz to 2400 MHz

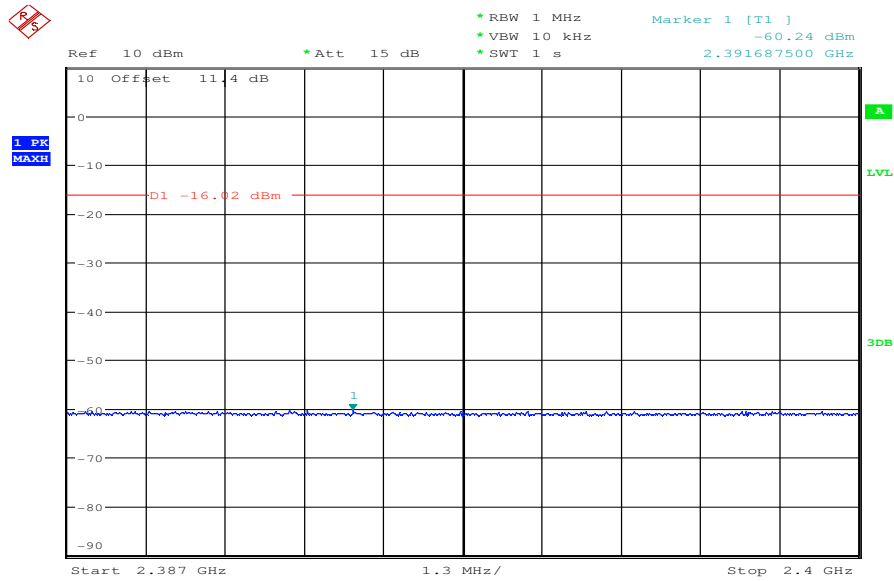

Date: 21.FEB.2011 08:51:59

Plot 14: TX mode, highest channel, 2483.5 MHz to 2496.5 MHz

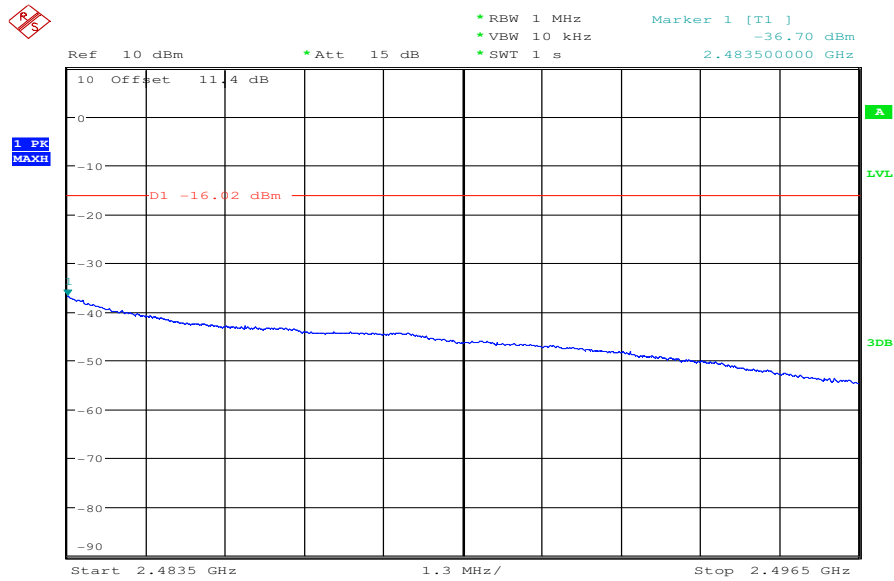

Date: 21.FEB.2011 09:22:30

Plot 15: TX mode, highest channel, 2496.5 MHz to 12500 MHz

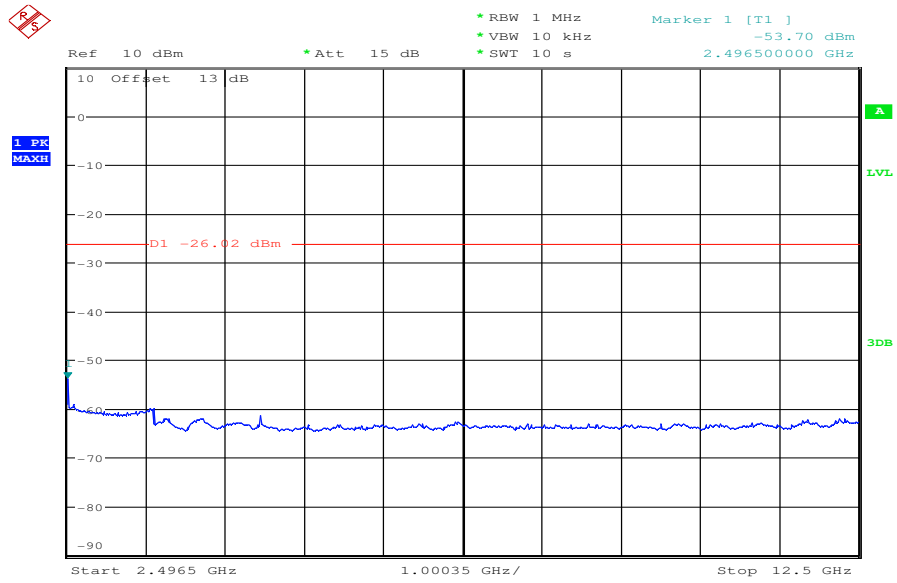

Date: 21.FEB.2011 09:29:31

8.4.5 Spurious emissions intensity - radiated

Measurement parameter:

Measurement parameter	
Detector:	Positive peak
Sweep time:	Auto
Resolution bandwidth:	f <= 1GHz : 100 kHz f > 1GHz : 1 MHz
Video bandwidth:	f <= 1GHz : 100 kHz f > 1GHz : 1 MHz
Span:	100 MHz steps
Trace-Mode:	Max Hold
Additional EUT parameters:	Test mode (modulated carrier) Modulation with highest output power used / Max power

Results:

DSSS / b – mode	lowest channel f _{TX} =2412 MHz		mid channel f _{TX} =2442 MHz		highest channel f _{TX} =2472 MHz	
	F [MHz]	Level [dBm]	F [MHz]	Level [dBm]	F [MHz]	Level [dBm]
Found peaks:	No critical peaks found (see plots). The detected emissions below 1 GHz are a part of the evaluation board and not a part of the EUT.					

OFDM / g – mode	lowest channel f _{TX} =2412 MHz		mid channel f _{TX} =2442 MHz		highest channel f _{TX} =2472 MHz	
	F [MHz]	Level [dBm]	F [MHz]	Level [dBm]	F [MHz]	Level [dBm]
Found peaks:	No critical peaks found (see plots). The detected emissions below 1 GHz are a part of the evaluation board and not a part of the EUT.					

OFDM / n – mode	lowest channel f _{TX} =2412 MHz		mid channel f _{TX} =2442 MHz		highest channel f _{TX} =2472 MHz	
	F [MHz]	Level [dBm]	F [MHz]	Level [dBm]	F [MHz]	Level [dBm]
Found peaks:	No critical peaks found (see plots). The detected emissions below 1 GHz are a part of the evaluation board and not a part of the EUT.					

Limit:

Limit	30 MHz <= f < 2387 MHz: 2.5uW (-26 dBm) 2387 MHz <= f < 2400 MHz: 25uW (-16 dBm) 2483.5 MHz < f <= 2496.5 MHz: 25uW (-16 dBm) 2496.5 MHz > f and 12500 MHz < f : 2.5uW (-26 dBm)
-------	---

Result: The result of the measurement is passed.

Plots: DSSS / b – mode, power index 45, 11 Mbit/s

Plot 1: TX mode, lowest channel, up to 1 GHz, vertical

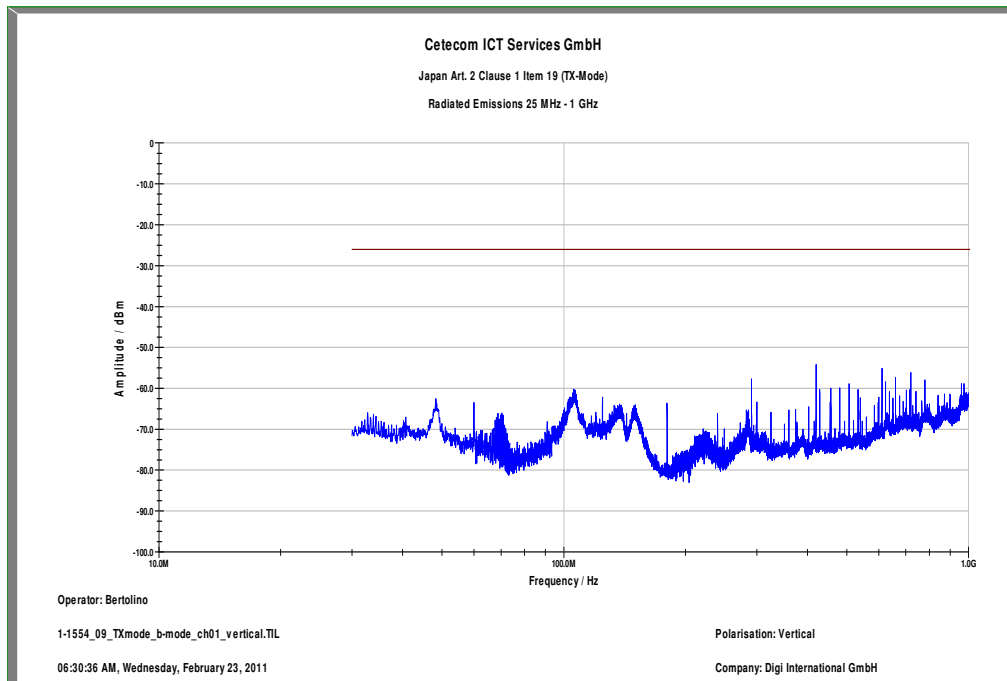

Plot 2: TX mode, lowest channel, 1 GHz to 12.75 GHz, vertical

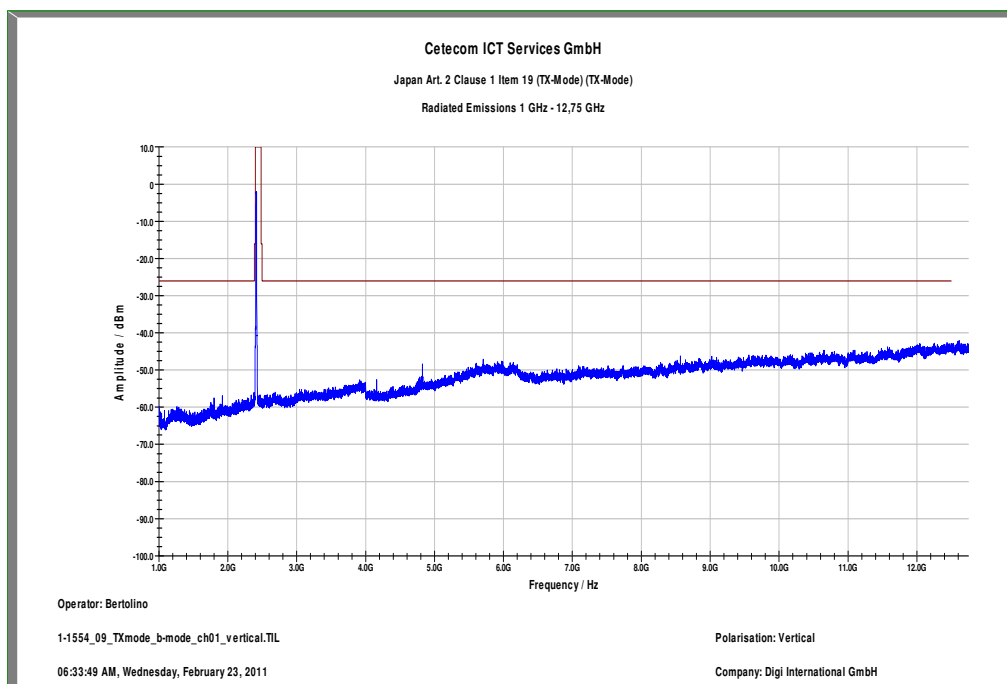

Plot 3: TX mode, lowest channel, up to 1 GHz, horizontal

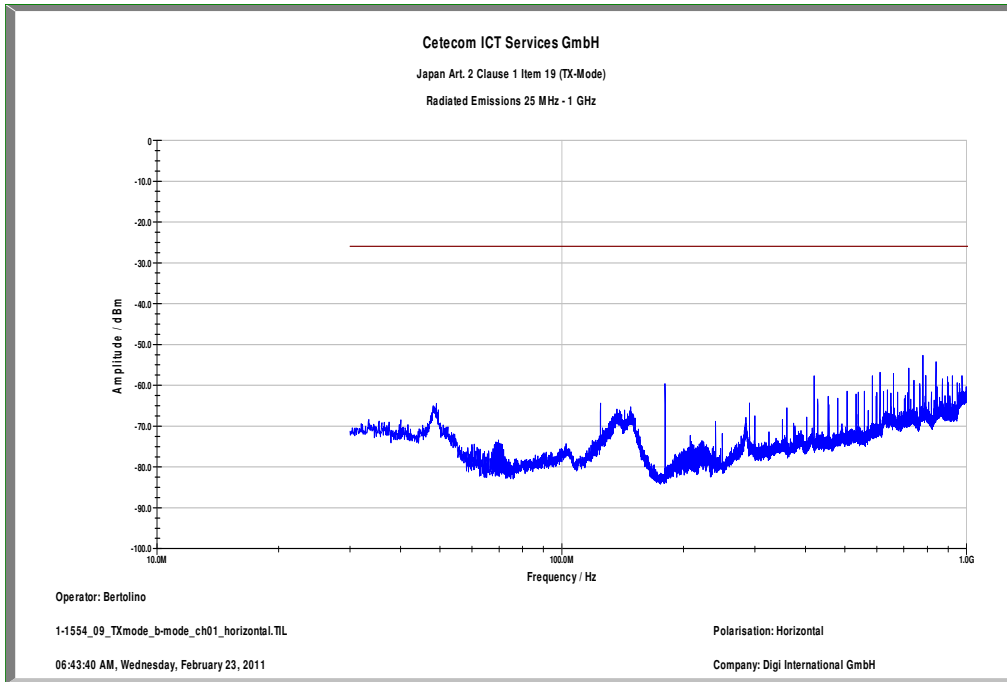

Plot 4: TX mode, lowest channel, 1 GHz to 12.75 GHz, horizontal

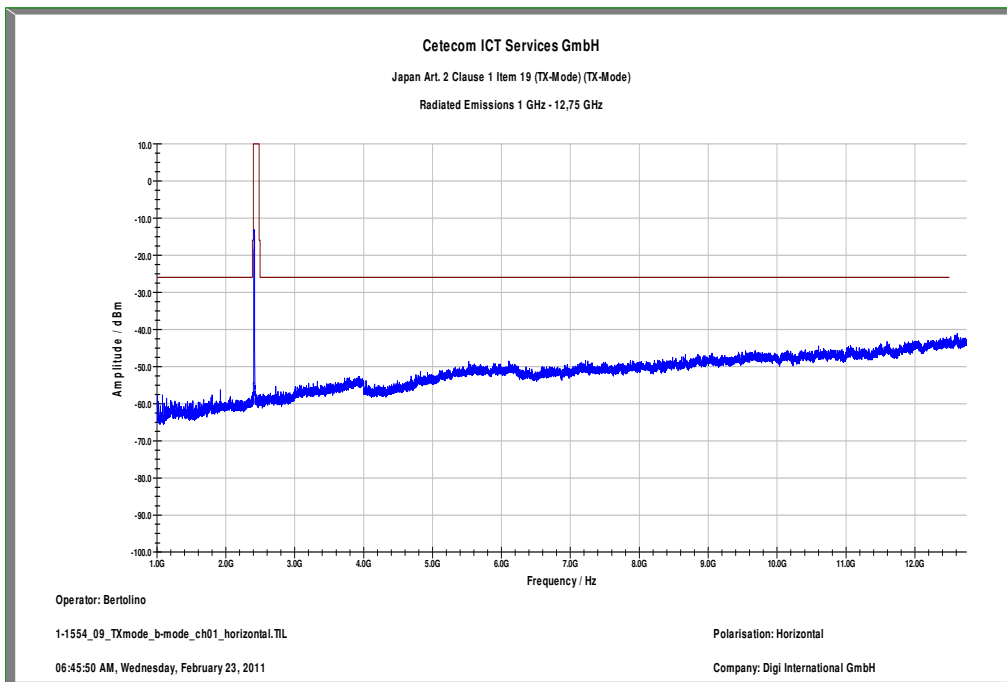

Plot 5: TX mode, middle channel, up to 1 GHz, vertical

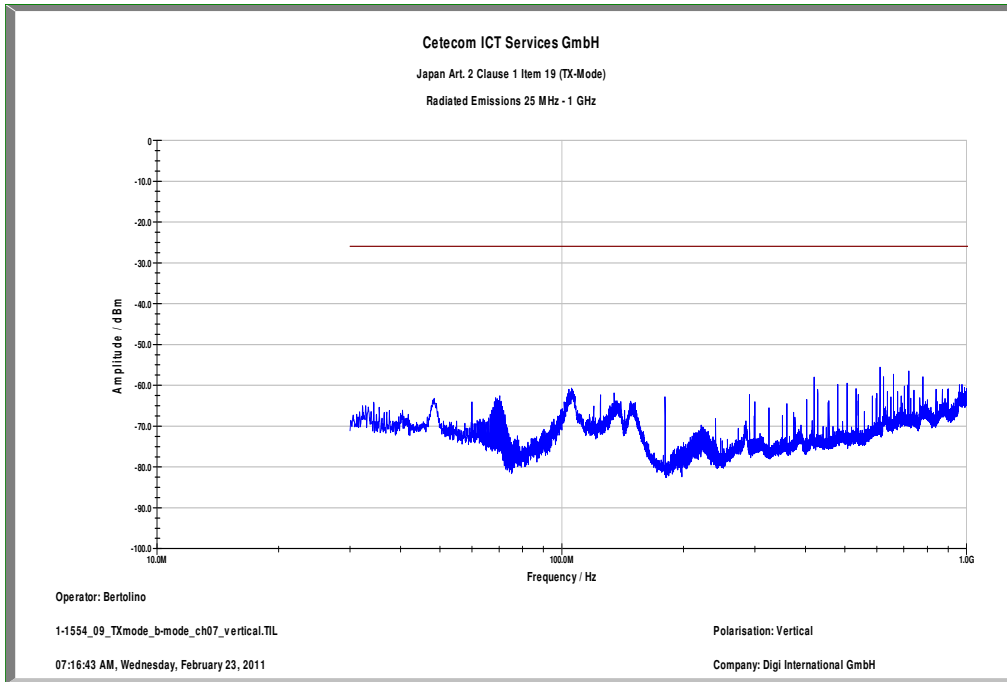

Plot 6: TX mode, middle channel, 1 GHz to 12.75 GHz, vertical

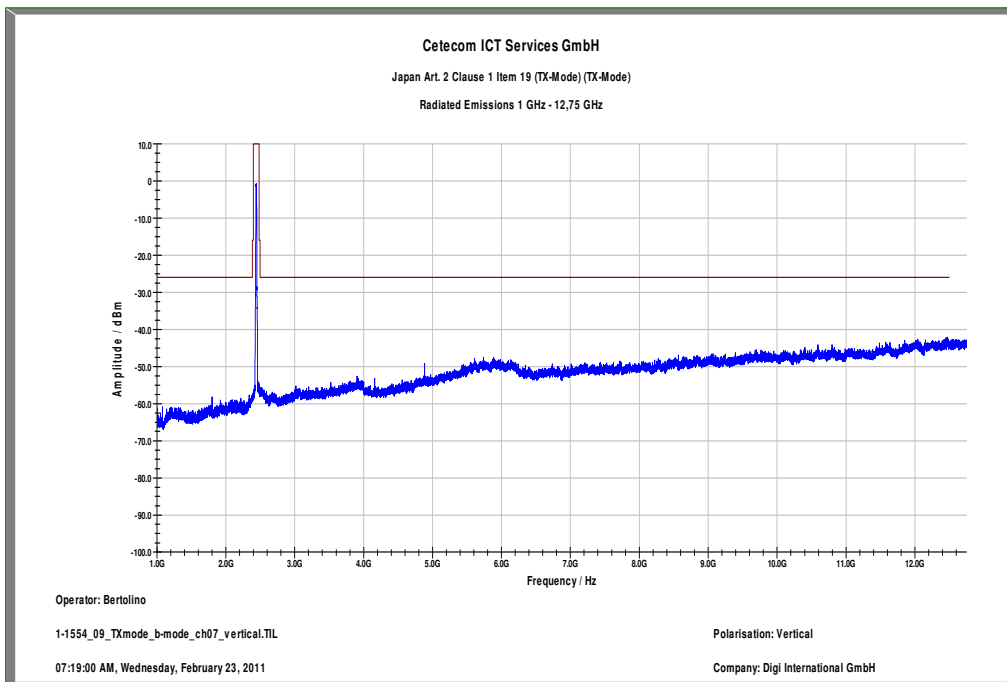

Plot 7: TX mode, middle channel, up to 1 GHz, horizontal

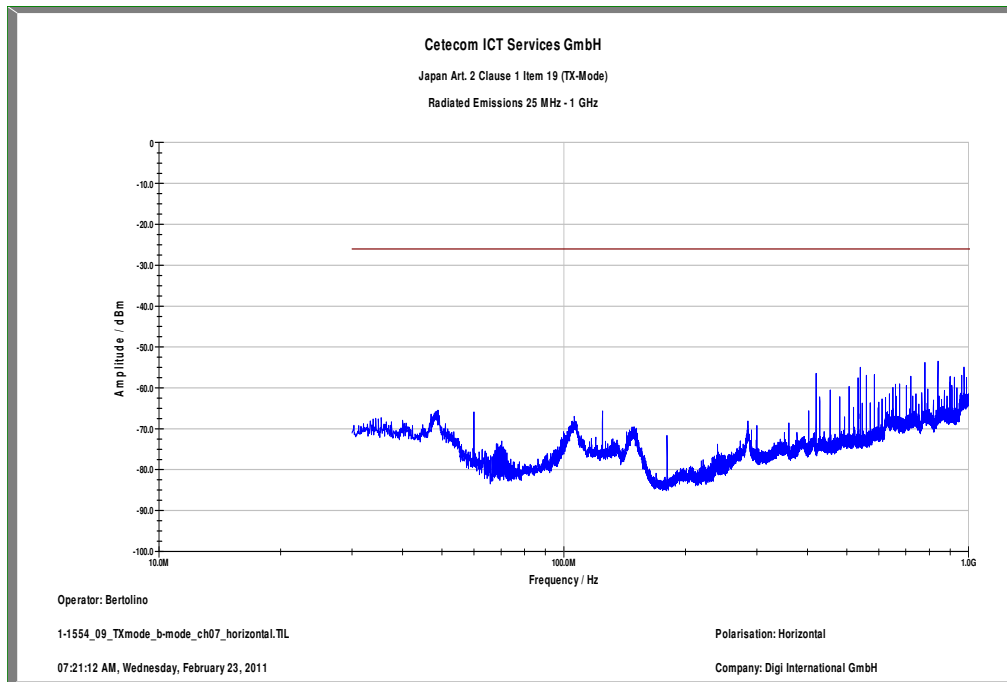

Plot 8: TX mode, middle channel, 1 GHz to 12.75 GHz, horizontal

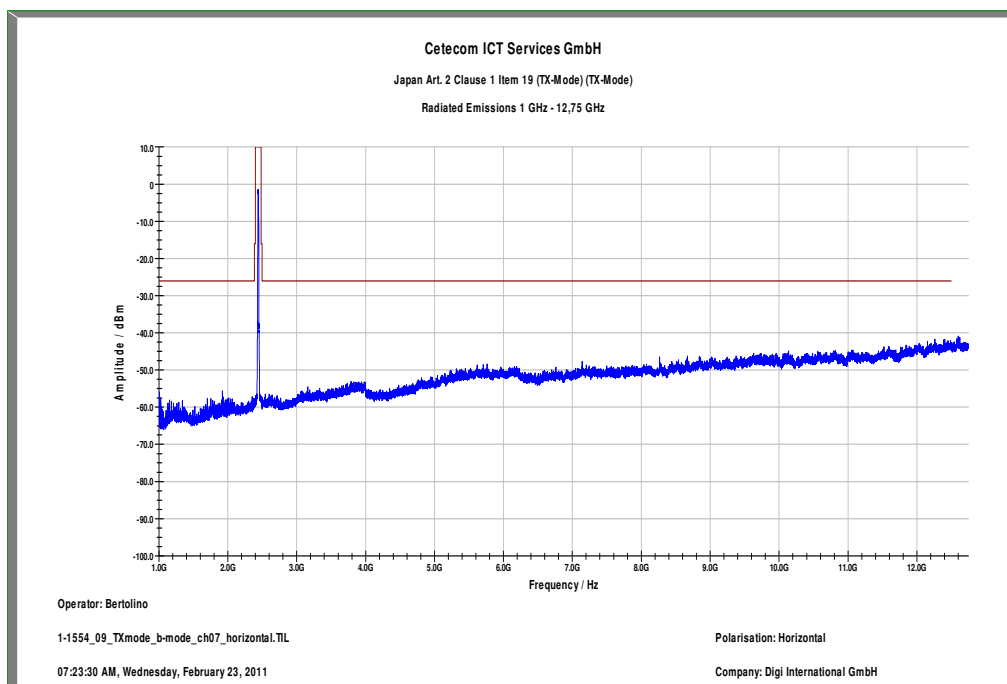

Plot 9: TX mode, highest channel, up to 1 GHz, vertical

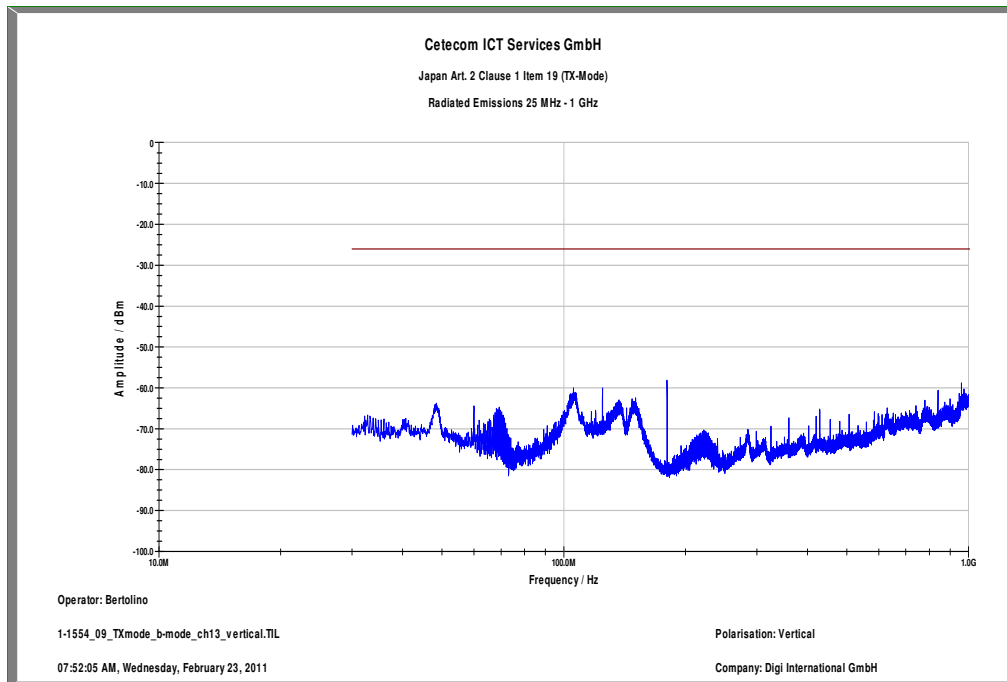

Plot 10: TX mode, highest channel, 1 GHz to 12.75 GHz, vertical

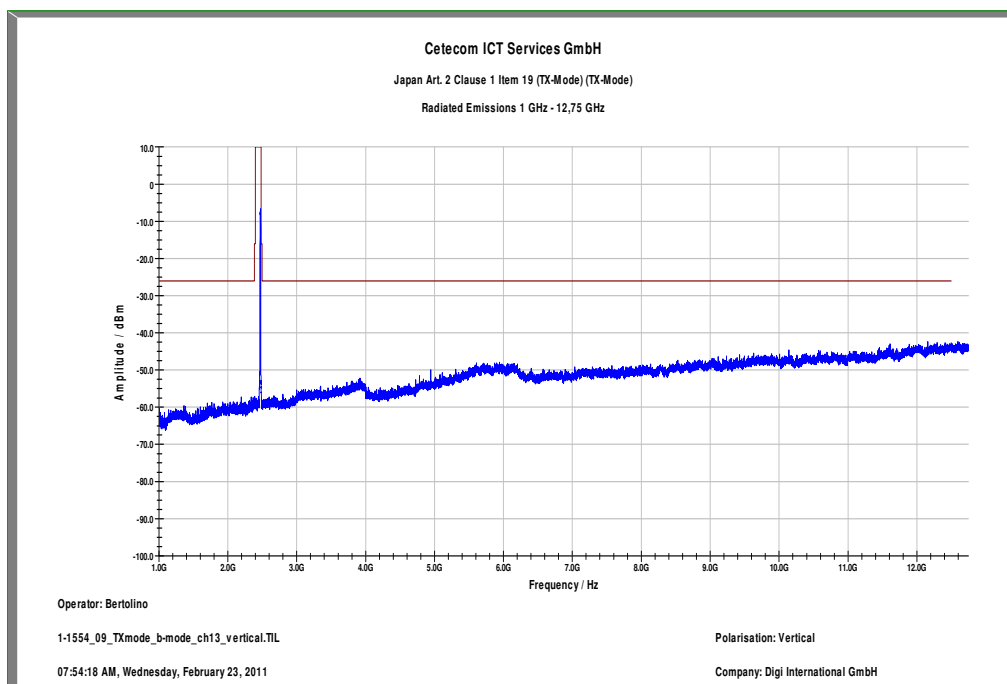

Plot 11: TX mode, highest channel, up to 1 GHz, horizontal

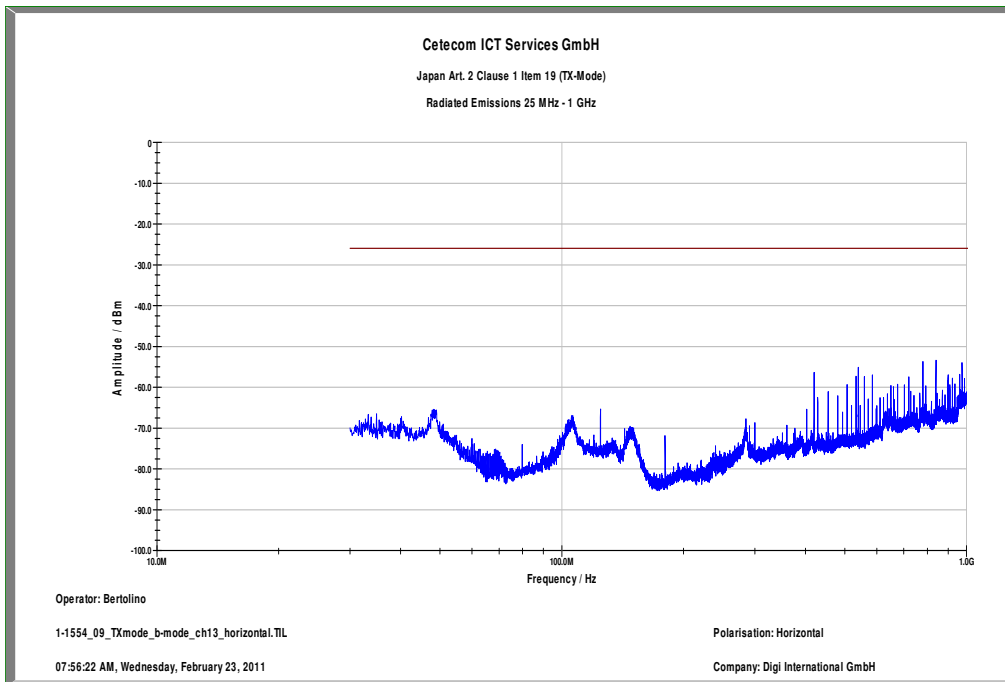

Plot 12: TX mode, highest channel, 1 GHz to 12.75 GHz, horizontal

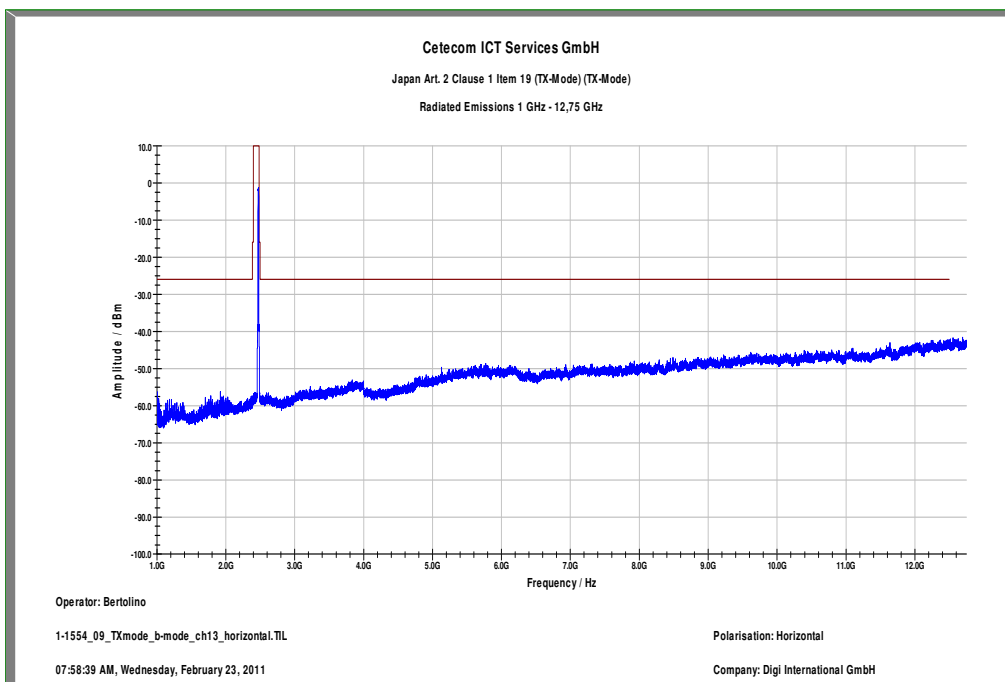

Plots: OFDM / g – mode, power index 45, 24 Mbit/s

Plot 1: TX mode, lowest channel, up to 1 GHz, vertical

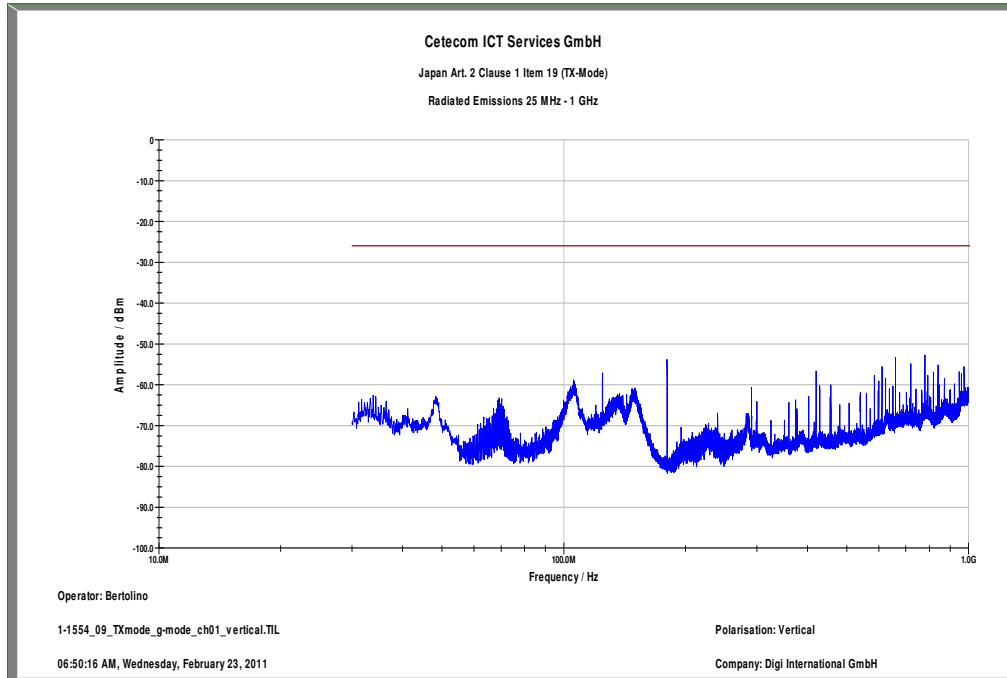

Plot 2: TX mode, lowest channel, 1 GHz to 12.75 GHz, vertical

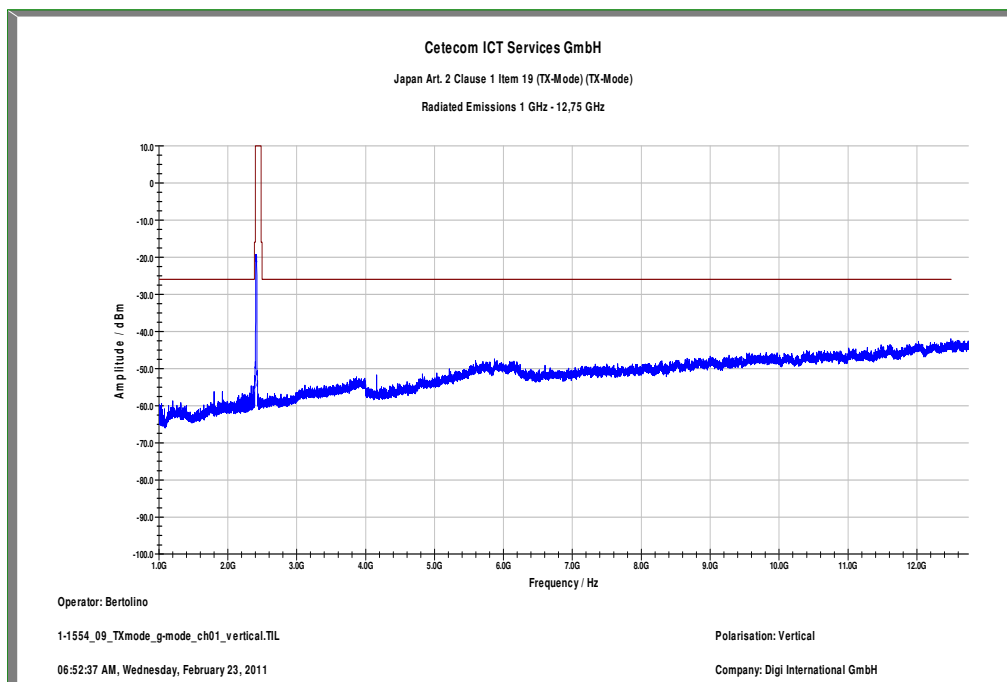

Plot 3: TX mode, lowest channel, up to 1 GHz, horizontal

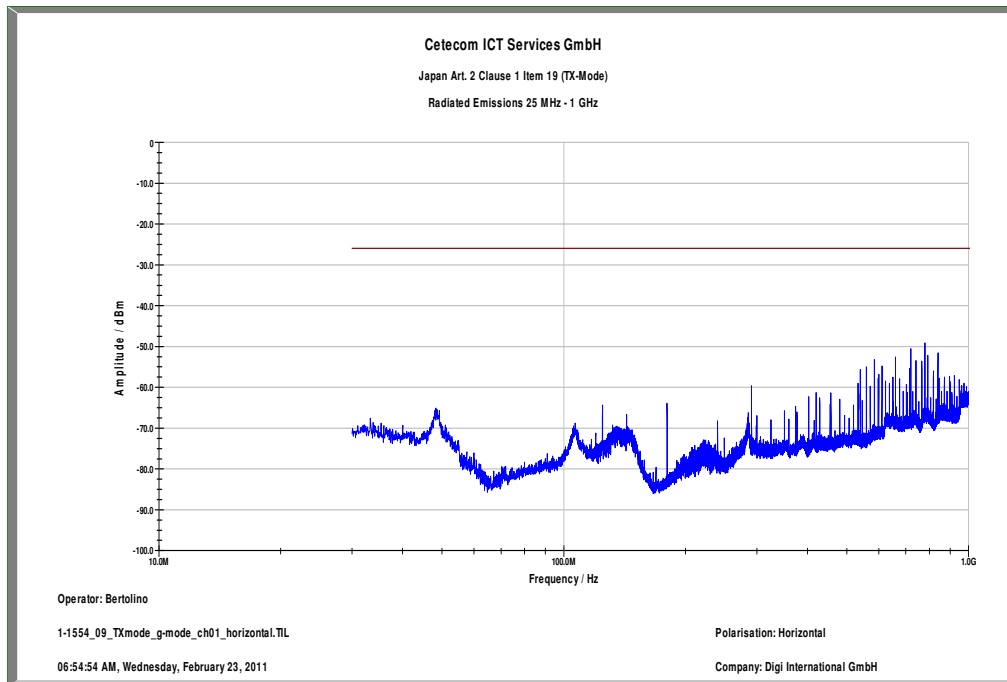

Plot 4: TX mode, lowest channel, 1 GHz to 12.75 GHz, horizontal

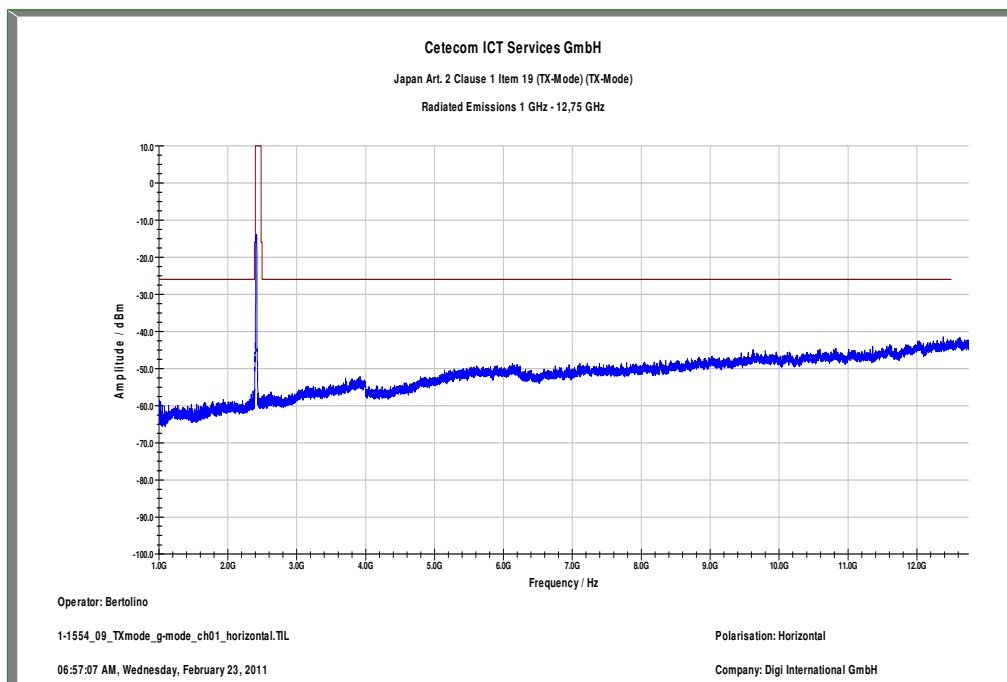

Plot 5: TX mode, middle channel, up to 1 GHz, vertical

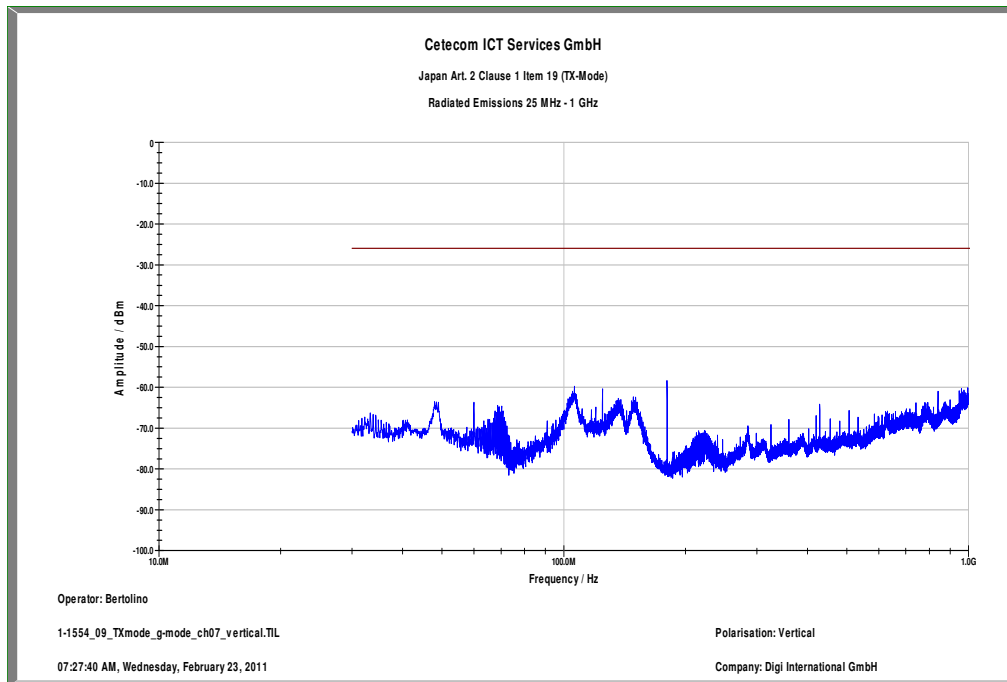

Plot 6: TX mode, middle channel, 1 GHz to 12.75 GHz, vertical

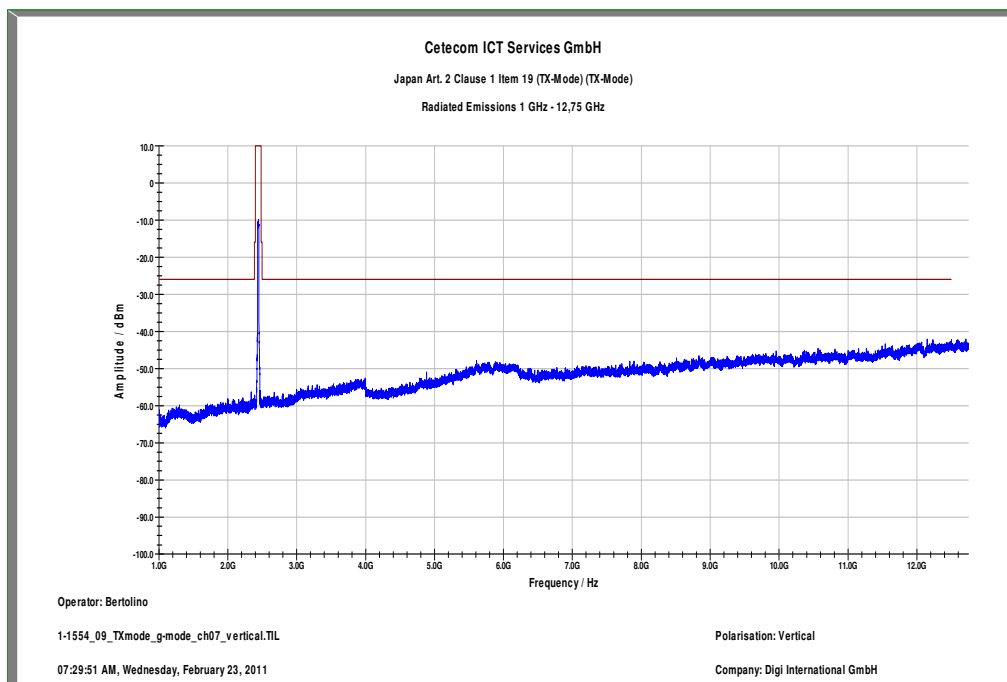

Plot 7: TX mode, middle channel, up to 1 GHz, horizontal

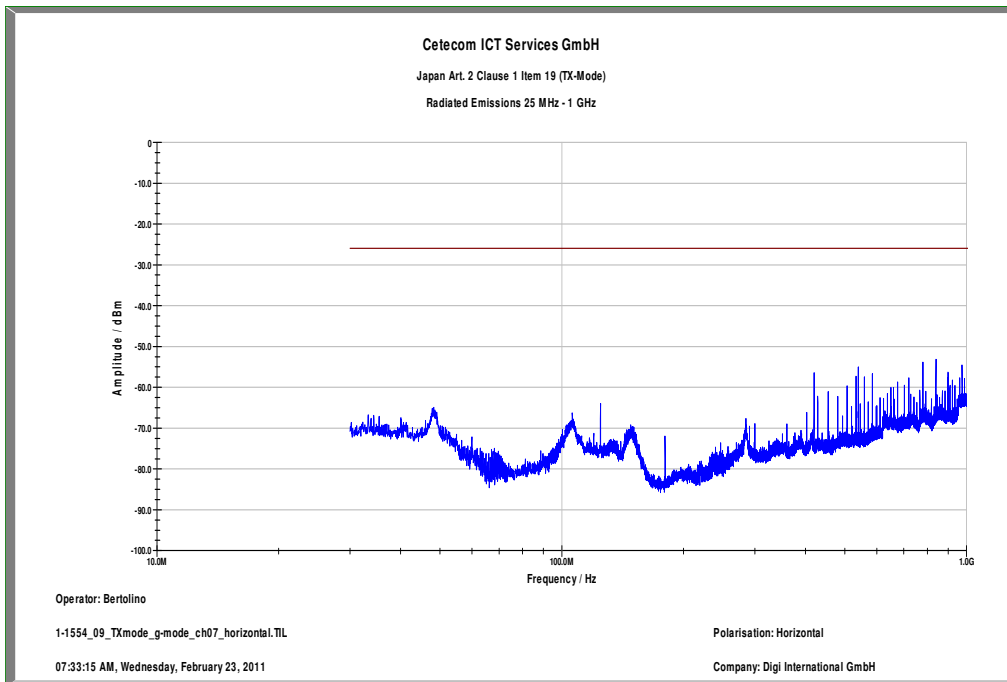

Plot 8: TX mode, middle channel, 1 GHz to 12.75 GHz, horizontal

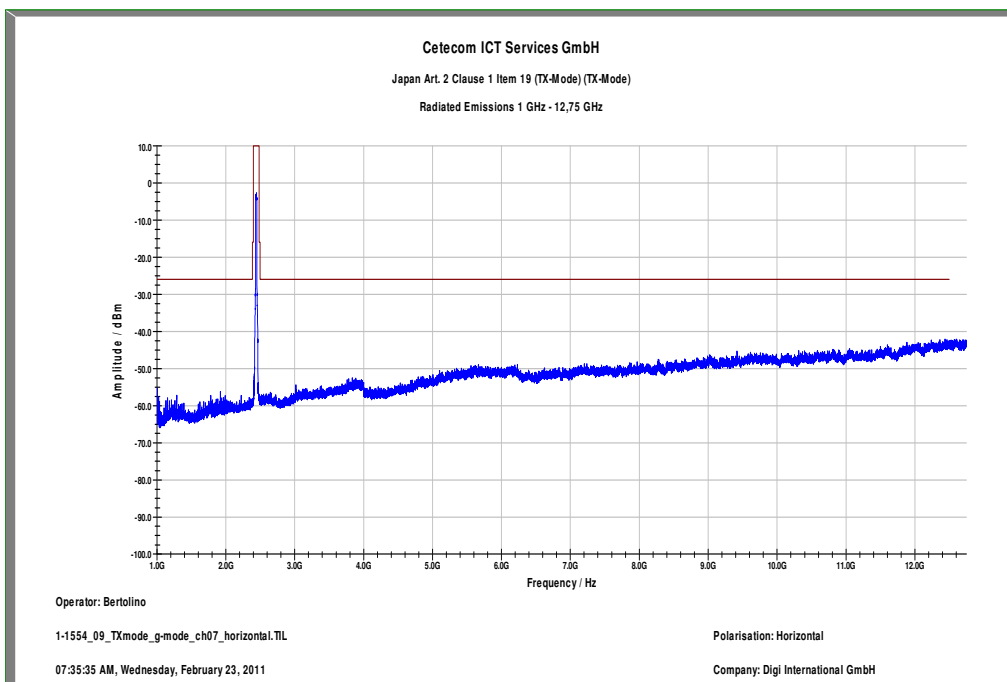

Plot 9: TX mode, highest channel, up to 1 GHz, vertical

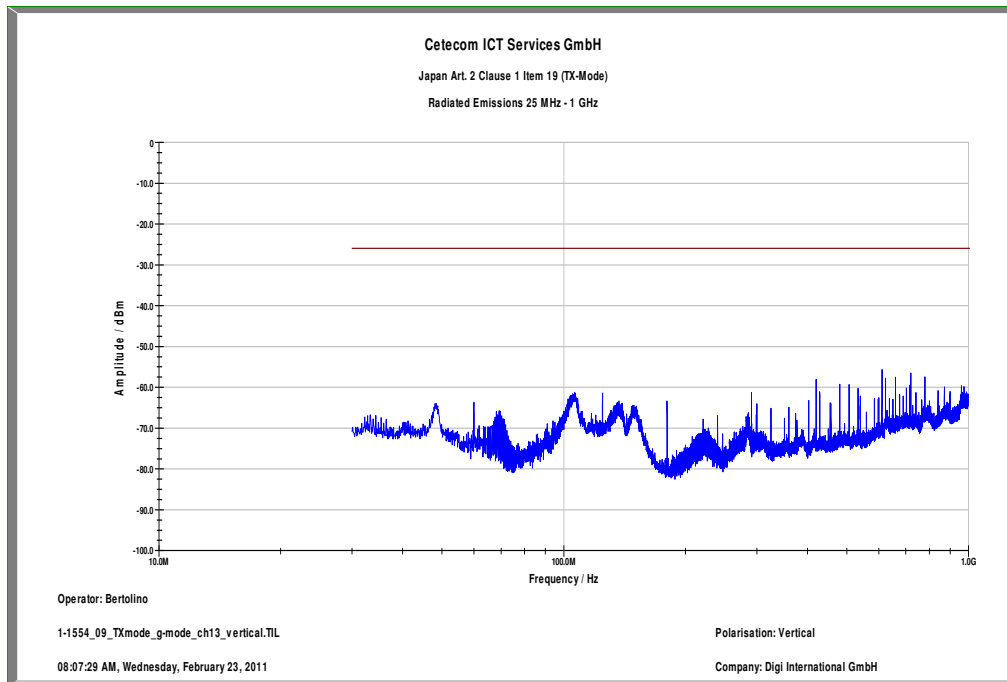

Plot 10: TX mode, highest channel, 1 GHz to 12.75 GHz, vertical

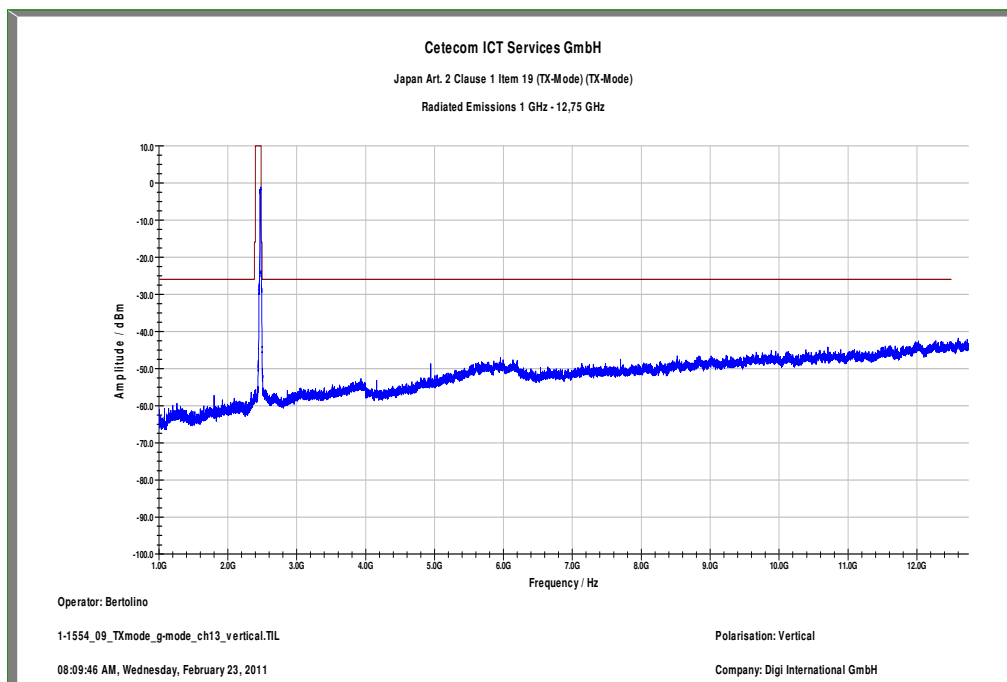

Plot 11: TX mode, highest channel, up to 1 GHz, horizontal

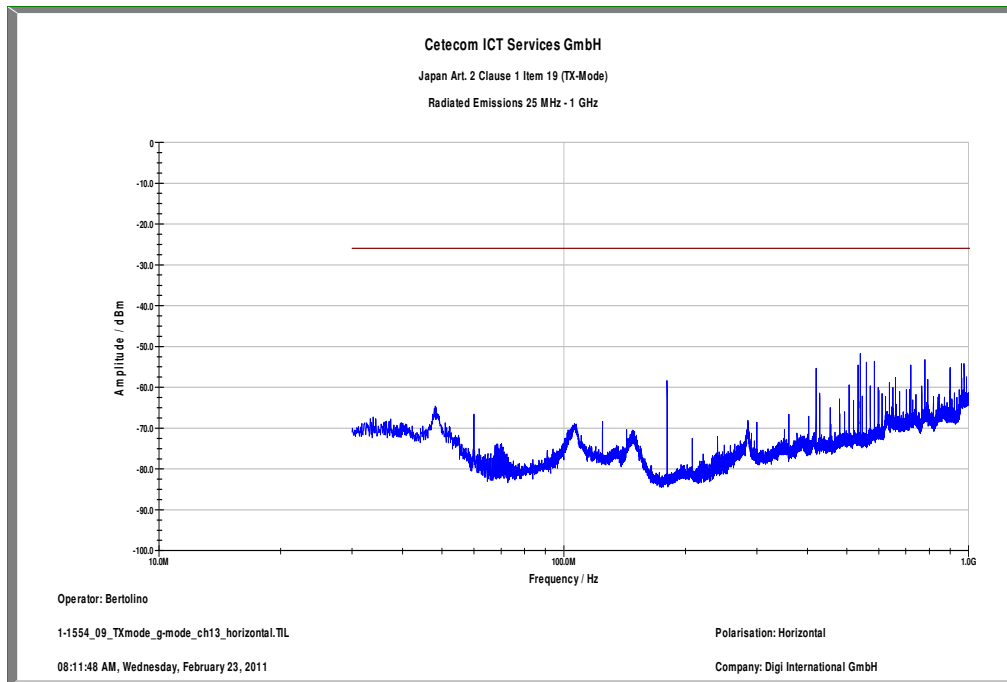

Plot 12: TX mode, highest channel, 1 GHz to 12.75 GHz, horizontal

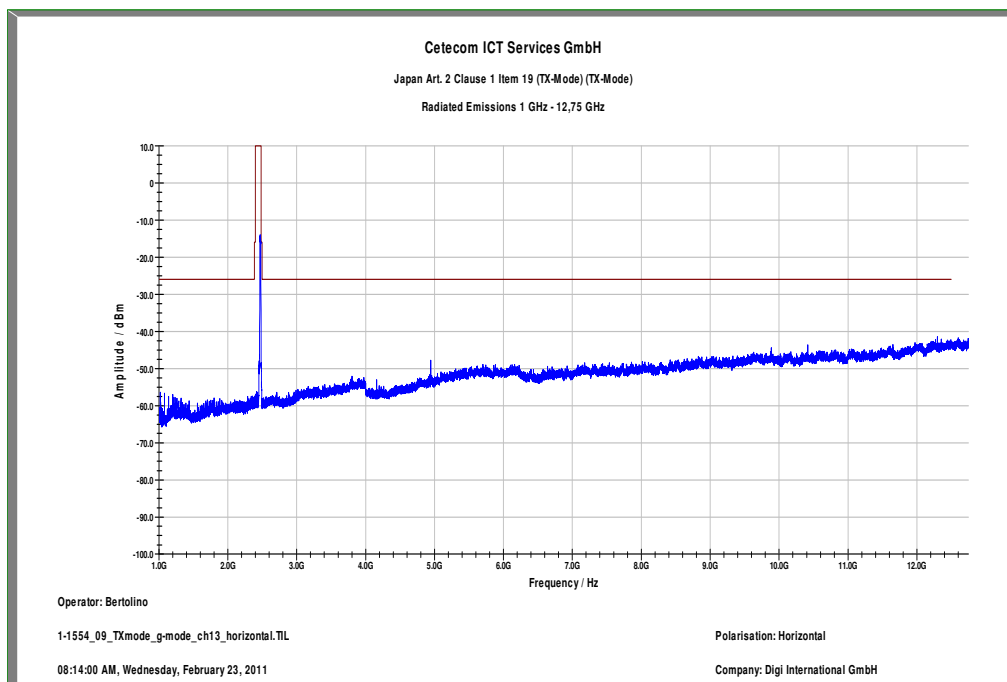

Plots: OFDM / n – mode, power index 45, MCS7

Plot 1: TX mode, lowest channel, up to 1 GHz, vertical

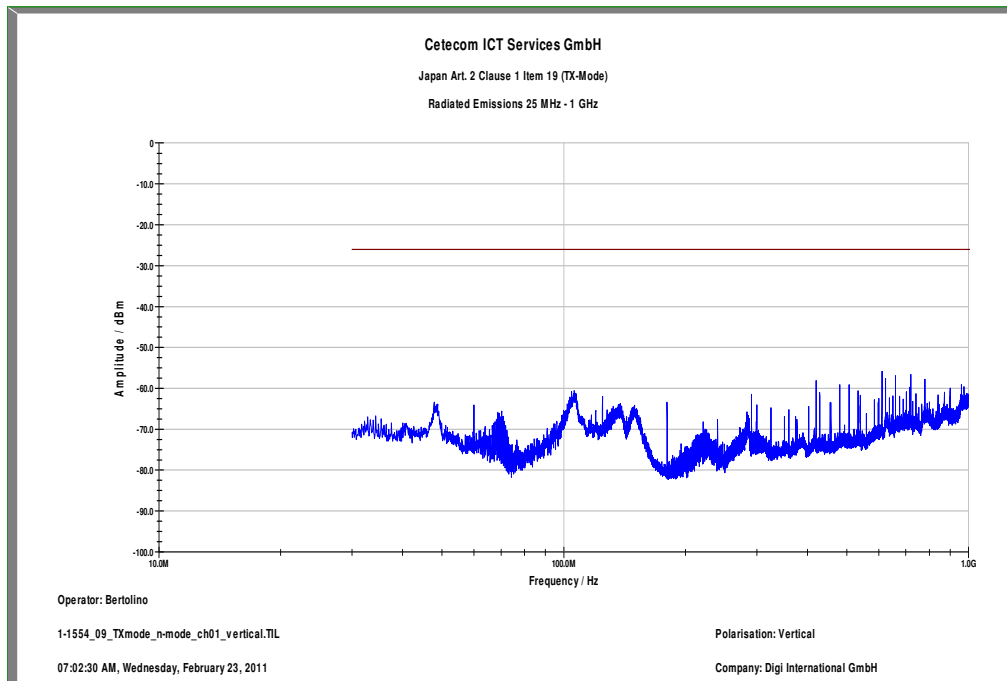

Plot 2: TX mode, lowest channel, 1 GHz to 12.75 GHz, vertical

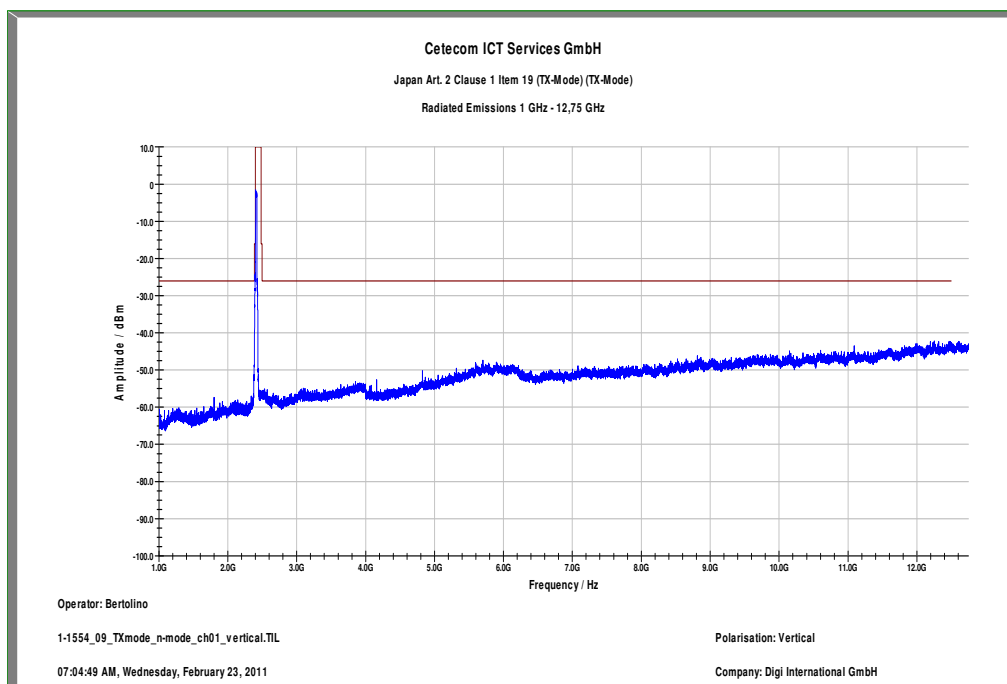

Plot 3: TX mode, lowest channel, up to 1 GHz, horizontal

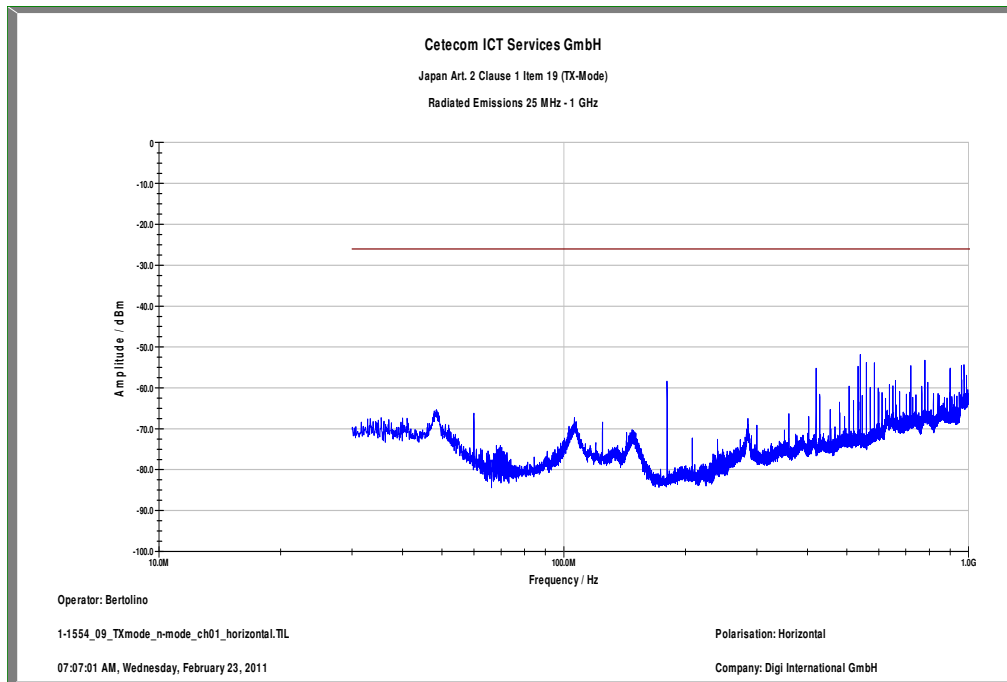

Plot 4: TX mode, lowest channel, 1 GHz to 12.75 GHz, horizontal

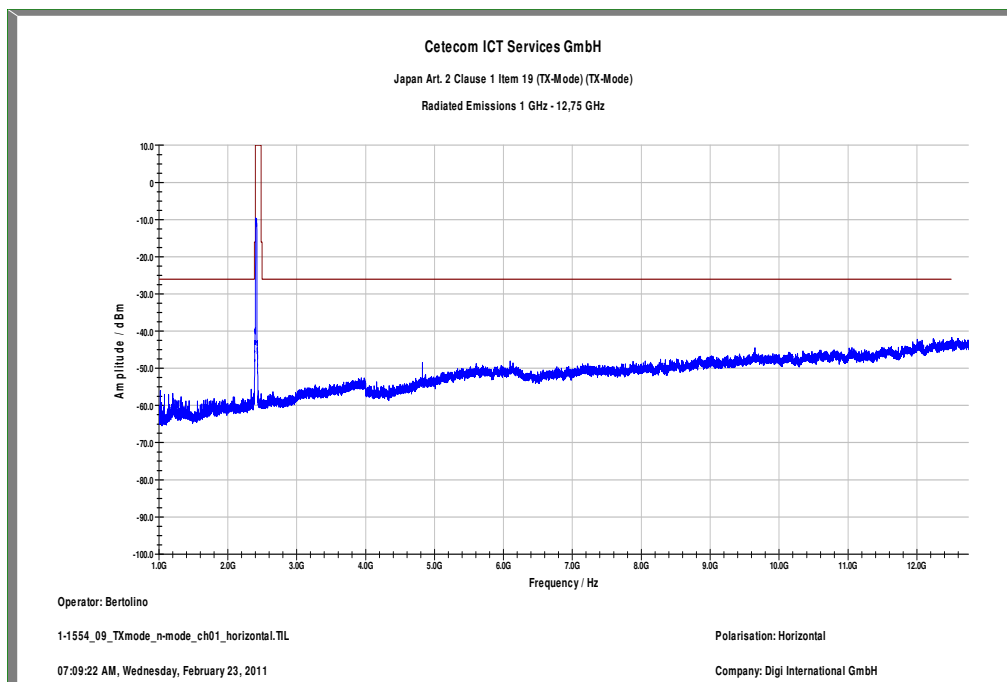

Plot 5: TX mode, middle channel, up to 1 GHz, vertical

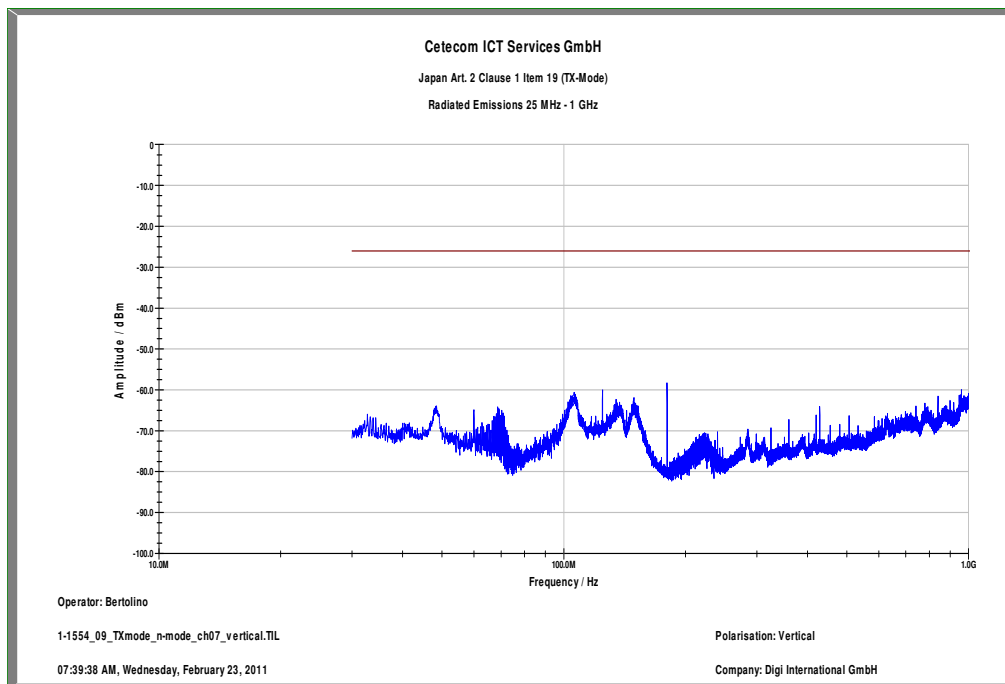

Plot 6: TX mode, middle channel, 1 GHz to 12.75 GHz, vertical

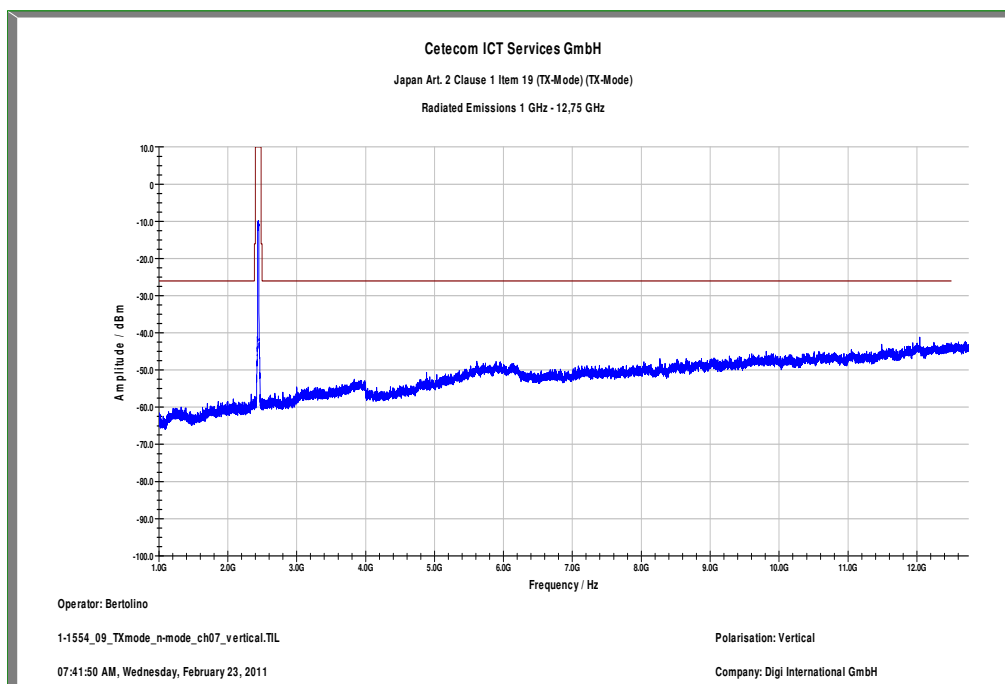

Plot 7: TX mode, middle channel, up to 1 GHz, horizontal

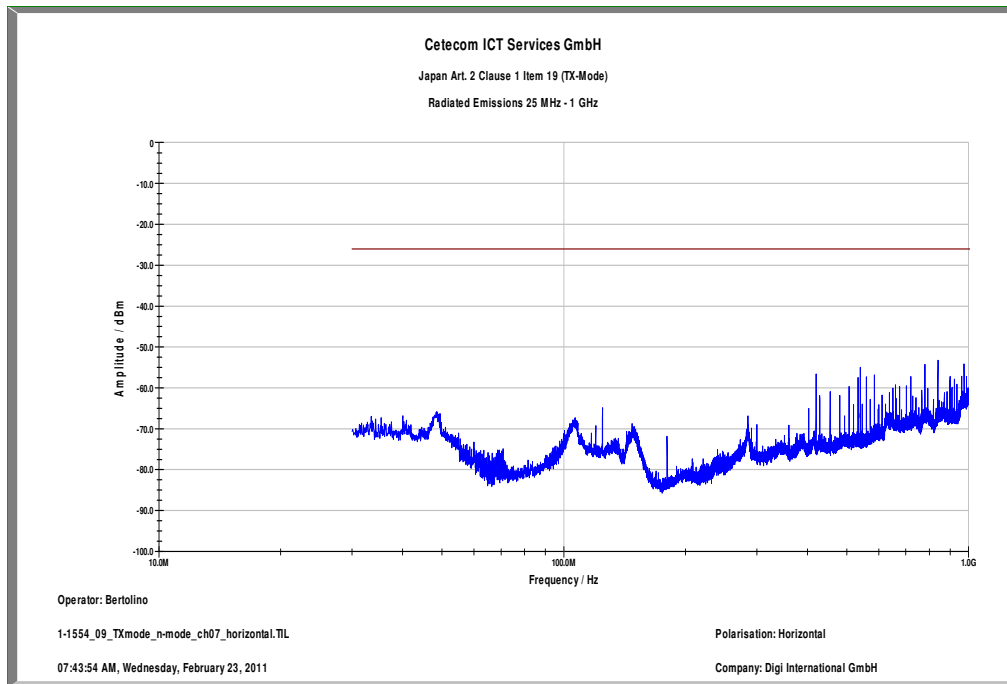

Plot 8: TX mode, middle channel, 1 GHz to 12.75 GHz, horizontal

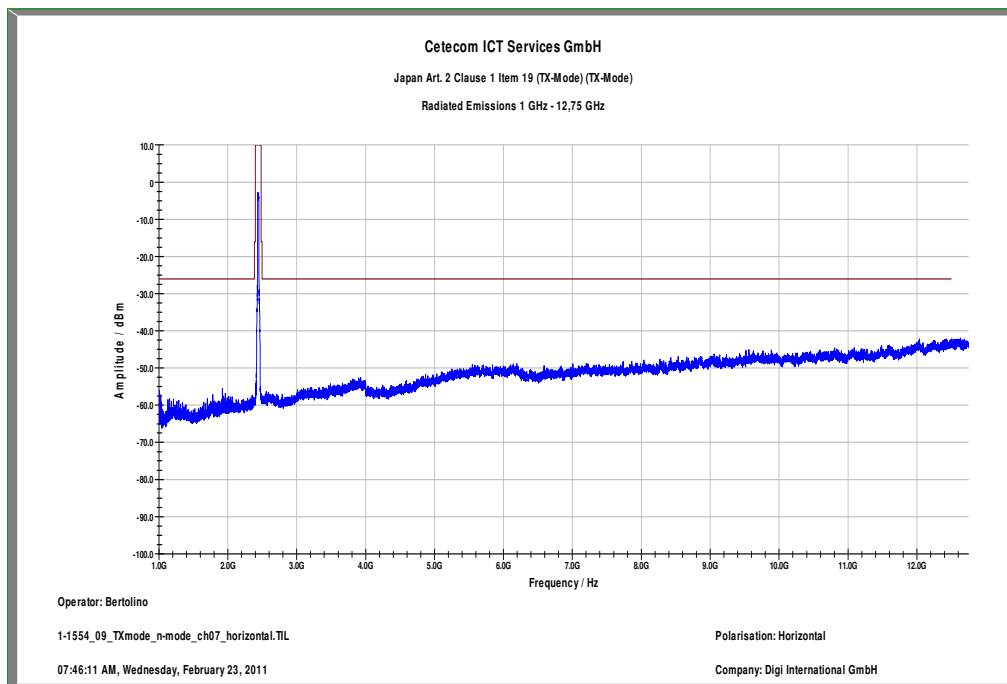

Plot 9: TX mode, highest channel, up to 1 GHz, vertical

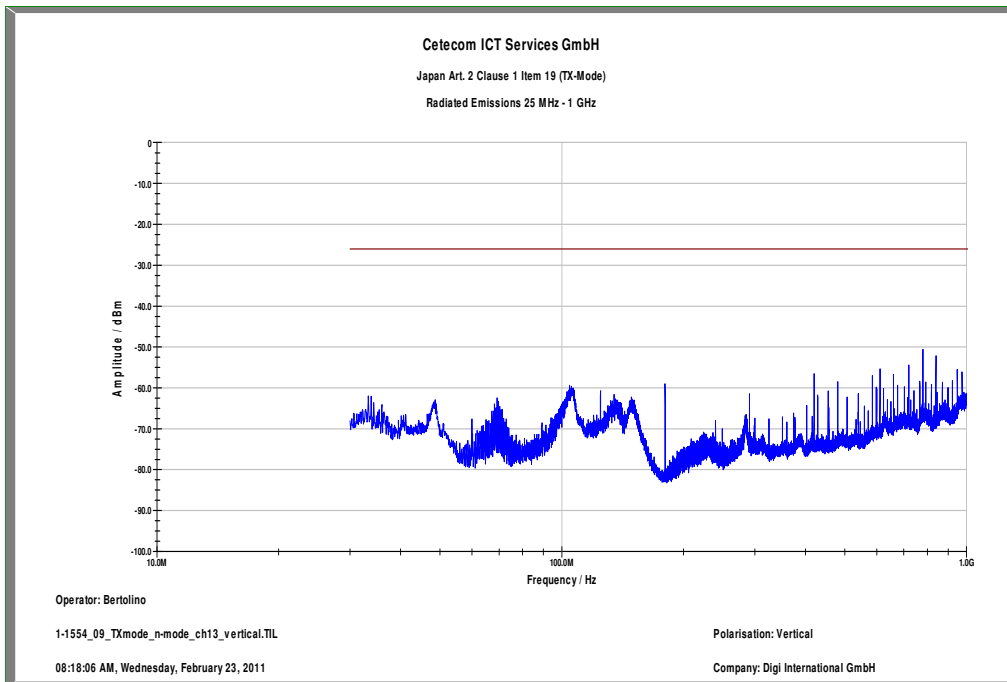

Plot 10: TX mode, highest channel, 1 GHz to 12.75 GHz, vertical

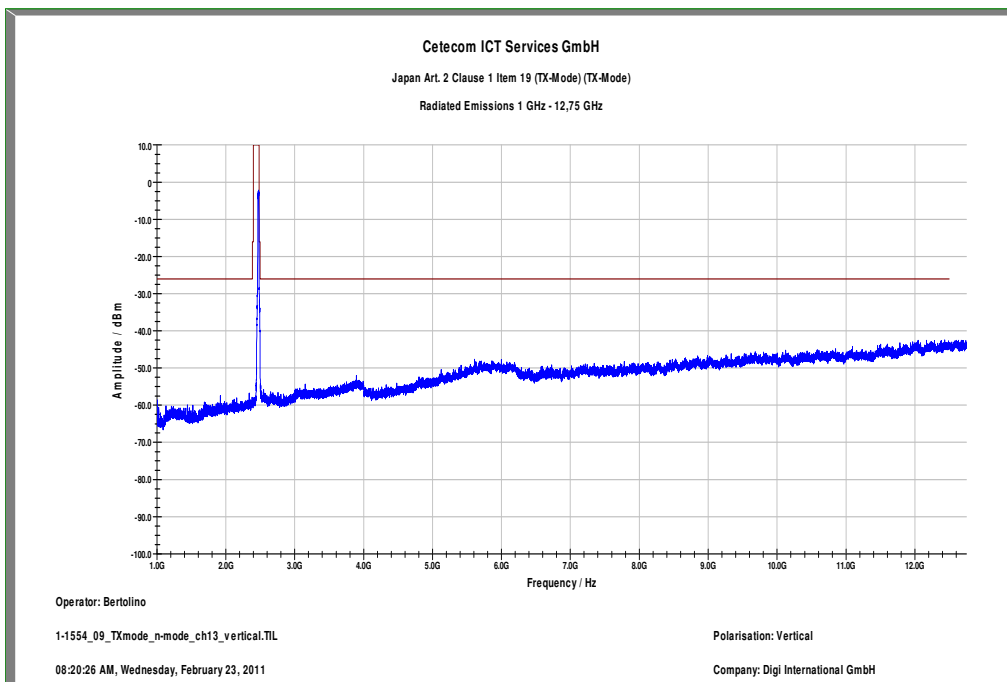

Plot 11: TX mode, highest channel, up to 1 GHz, horizontal

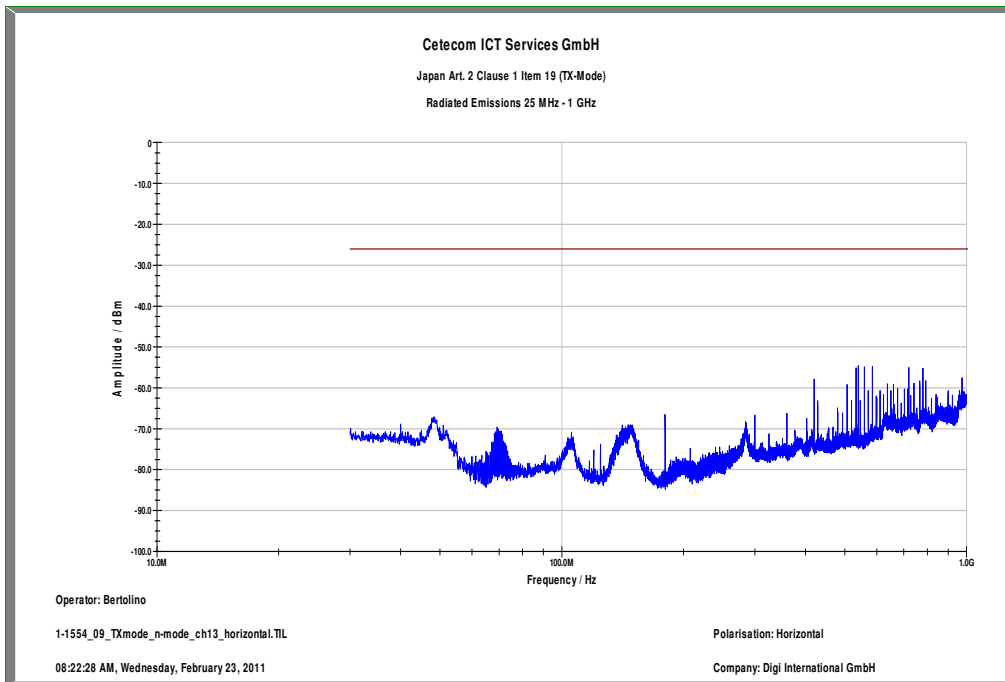

Plot 12: TX mode, highest channel, 1 GHz to 12.75 GHz, horizontal

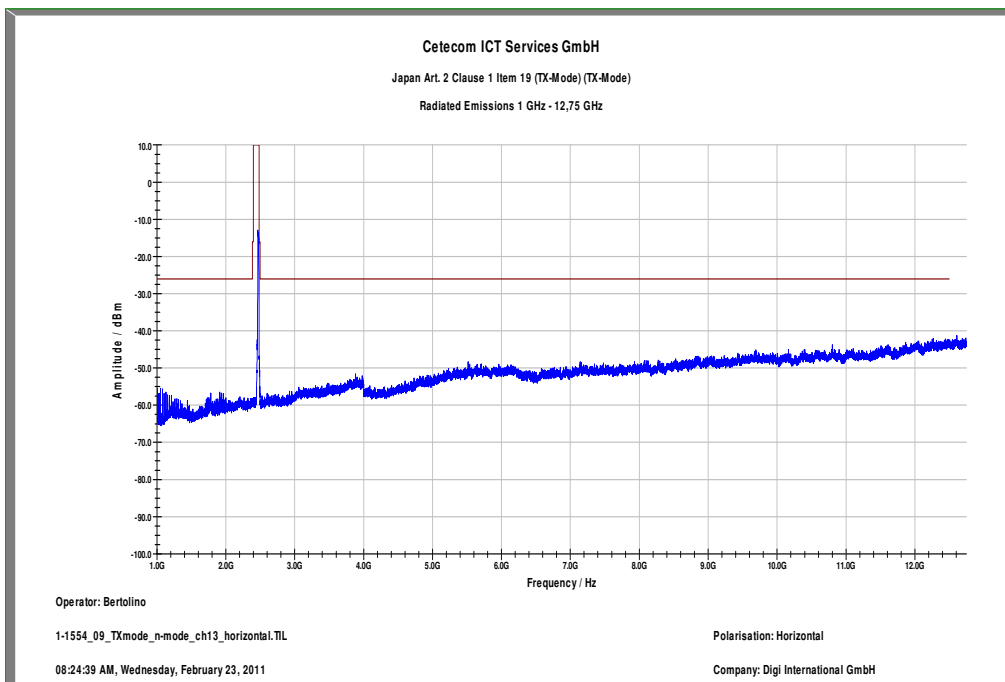

8.4.6 Occupied & spreading bandwidth

Measurement parameter:

Measurement parameter	
Detector:	Peak
Sweep time:	Auto
Resolution bandwidth:	100 kHz
Video bandwidth:	100 kHz
Span:	40 MHz
Trace-Mode:	Max Hold
Additional EUT parameters:	Max power

Results (normal Voltage): DSSS / b – mode

	lowest channel 2412 MHz	middle channel 2442 MHz	highest channel 2472 MHz
Occupied Bandwidth [MHz] (20dB Bandwidth)	13.78	13.65	13.72
Spreading Bandwidth [MHz] (10dB Bandwidth)	11.92	11.28	11.73

Results (normal Voltage): OFDM / g – mode

	lowest channel 2412 MHz	middle channel 2442 MHz	highest channel 2472 MHz
Occupied Bandwidth [MHz] (20dB Bandwidth)	18.33	18.33	18.33
Spreading Bandwidth [MHz] (10dB Bandwidth)	16.79	16.79	16.79

Results (normal Voltage): OFDM / n – mode

	lowest channel 2412 MHz	middle channel 2442 MHz	highest channel 2472 MHz
Occupied Bandwidth [MHz] (20dB Bandwidth)	19.17	19.10	19.10
Spreading Bandwidth [MHz] (10dB Bandwidth)	17.95	18.01	18.01

Limit:

Limit Occupied Bandwidth	< 26 MHz
Limit Spreading Bandwidth	> 500 kHz

Result: The result of the measurement is passed.

Plots: DSSS / b – mode, power index 45, 11 Mbit/s

Plot 1: lowest channel, 10 dB bandwidth

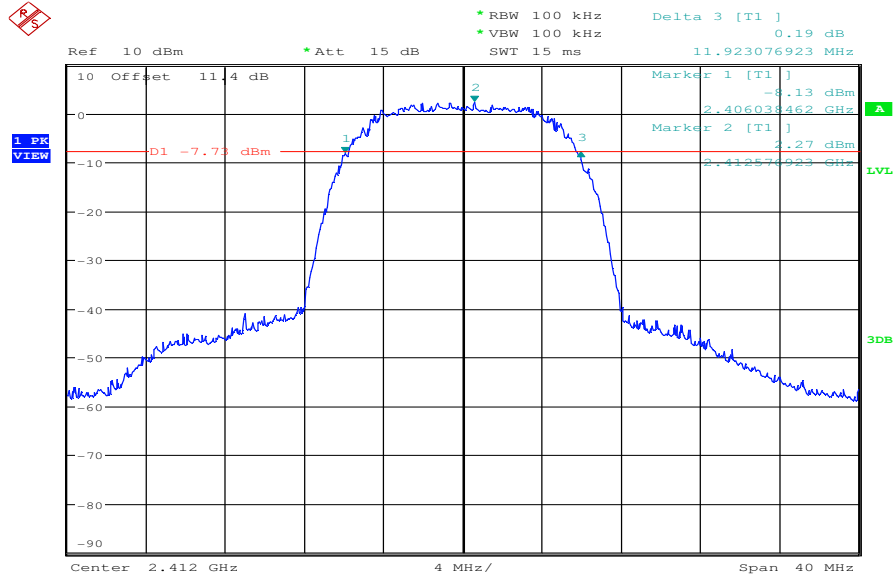

Date: 21.FEB.2011 06:54:38

Plot 2: lowest channel, 20 dB bandwidth

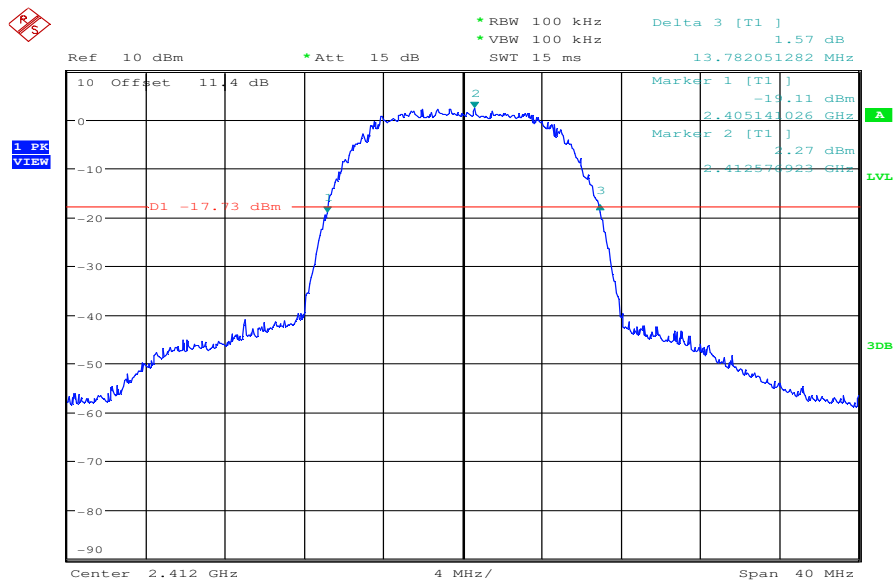

Date: 21.FEB.2011 06:55:20

Plot 3: middle channel, 10 dB bandwidth

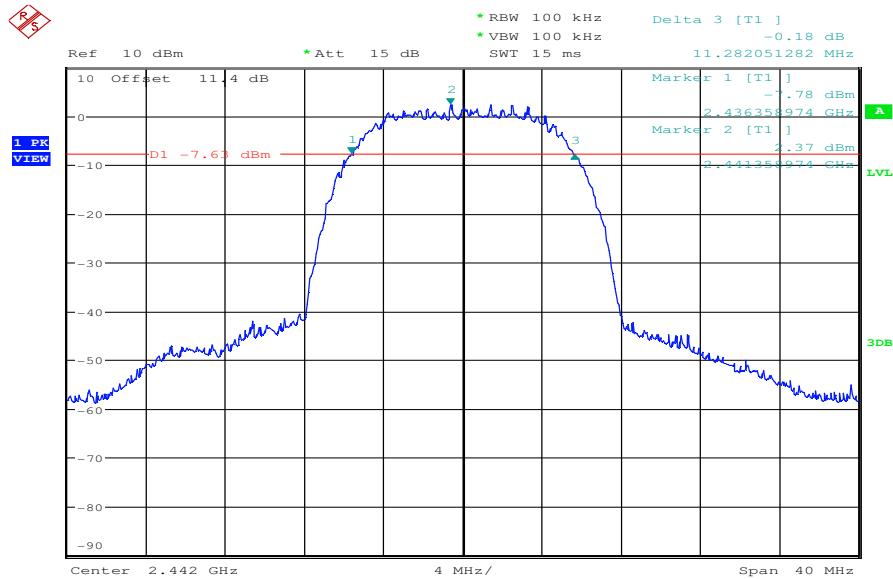

Date: 21.FEB.2011 06:57:37

Plot 4: middle channel, 20 dB bandwidth

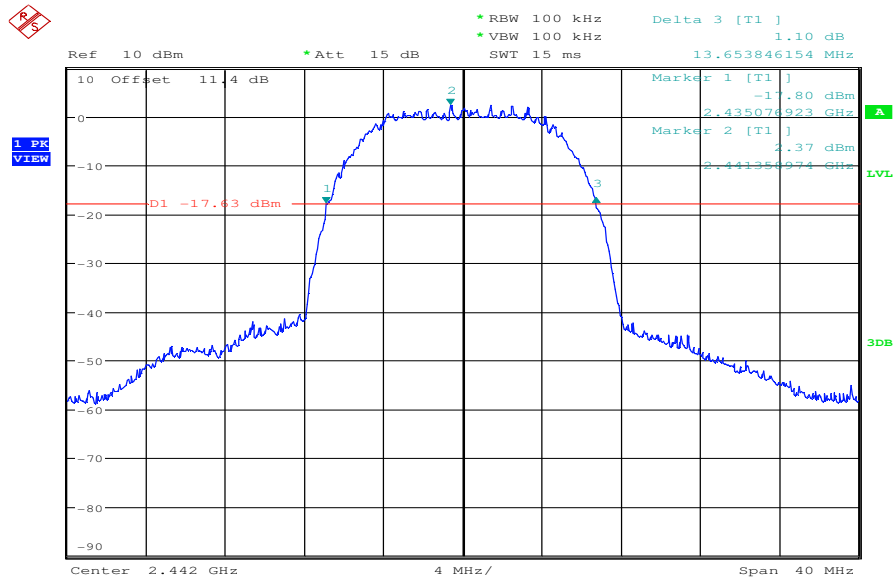

Date: 21.FEB.2011 06:58:18

Plot 5: highest channel, 10 dB bandwidth

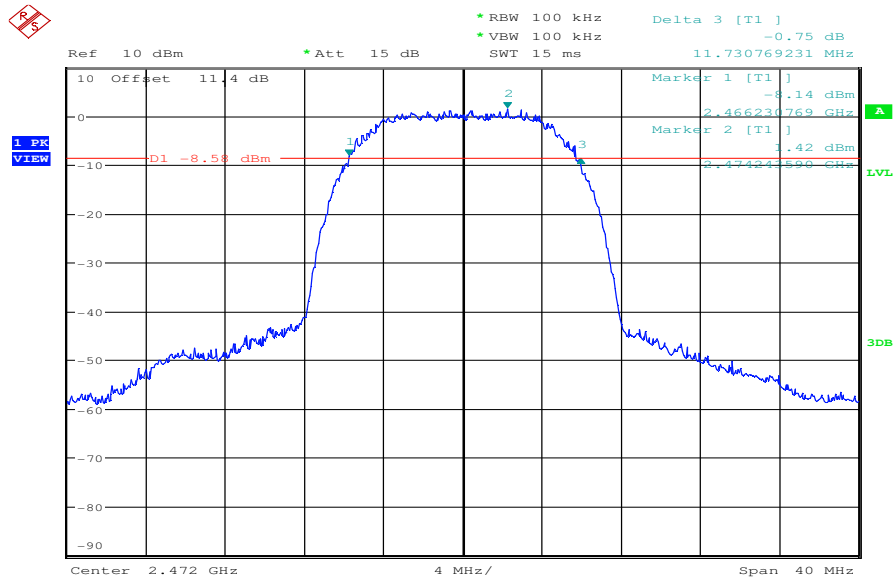

Date: 21.FEB.2011 07:00:28

Plot 6: highest channel, 20 dB bandwidth

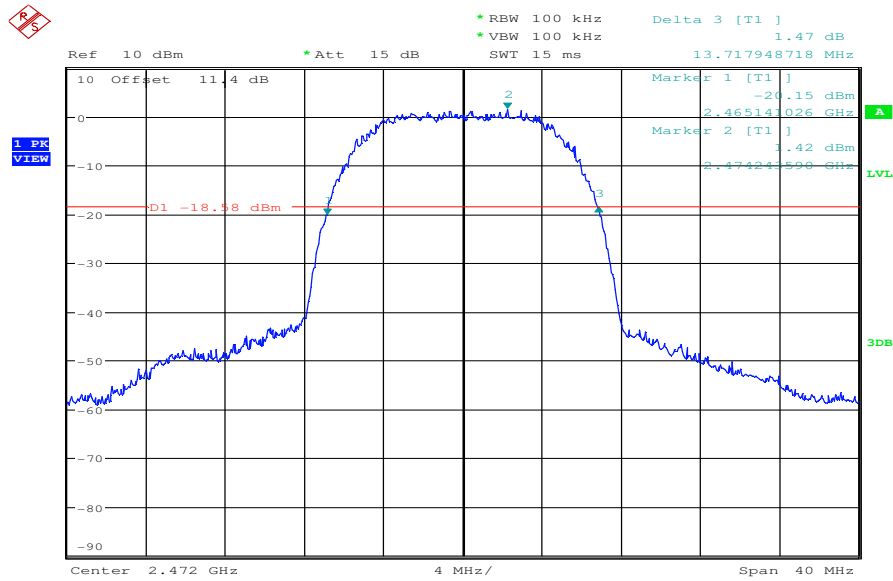

Date: 21.FEB.2011 07:01:12

Plots: OFDM / g – mode, power index 45, 24 Mbit/s

Plot 1: lowest channel, 10 dB bandwidth

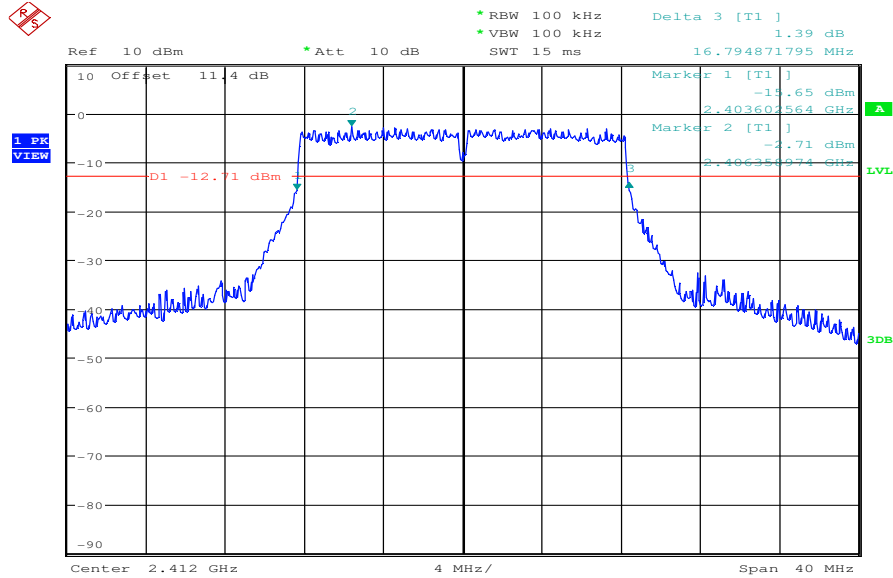

Date: 21.FEB.2011 07:07:47

Plot 2: lowest channel, 20 dB bandwidth

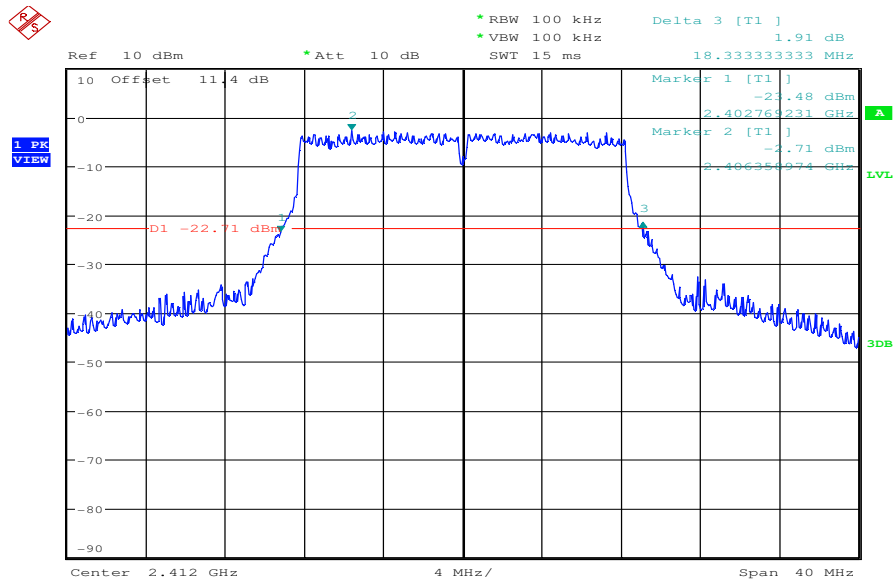

Date: 21.FEB.2011 07:08:20

Plot 3: middle channel, 10 dB bandwidth

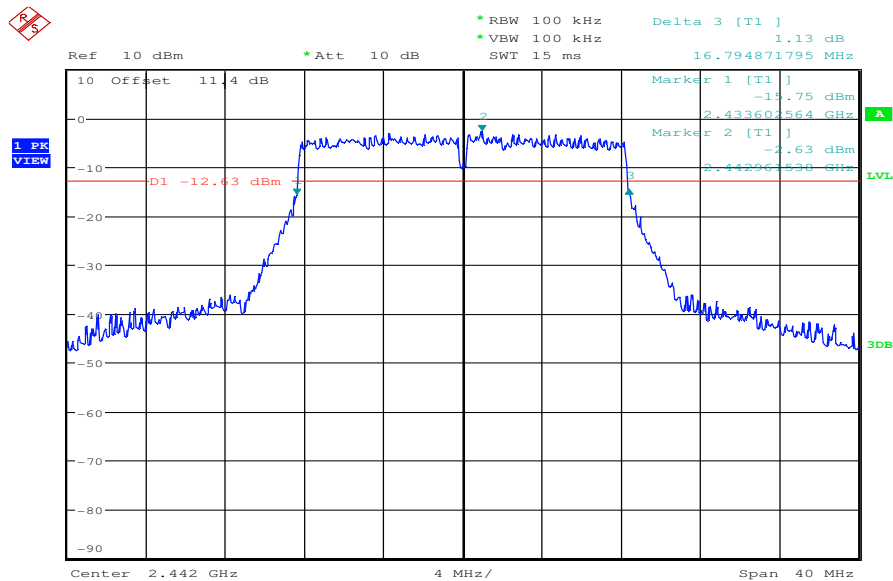

Date: 21.FEB.2011 07:10:05

Plot 4: middle channel, 20 dB bandwidth

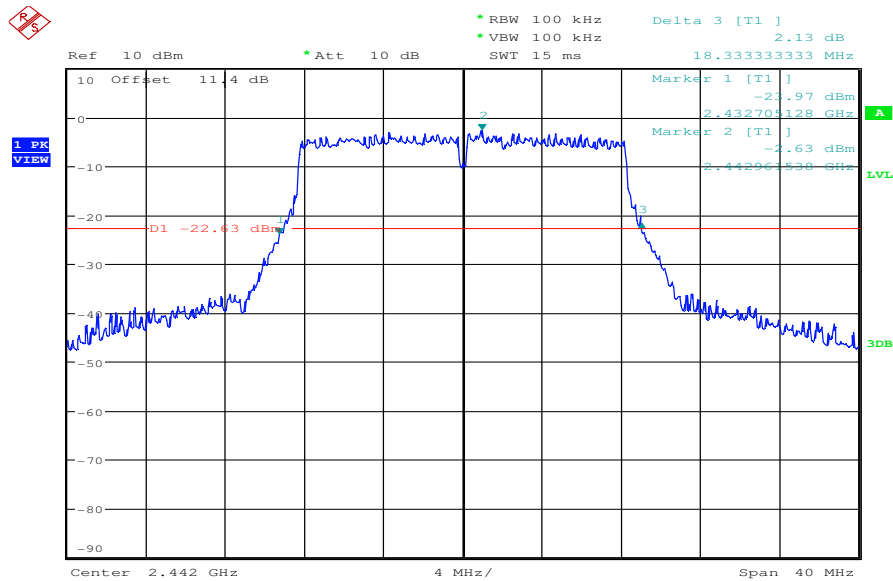

Date: 21.FEB.2011 07:10:35

Plot 5: highest channel, 10 dB bandwidth

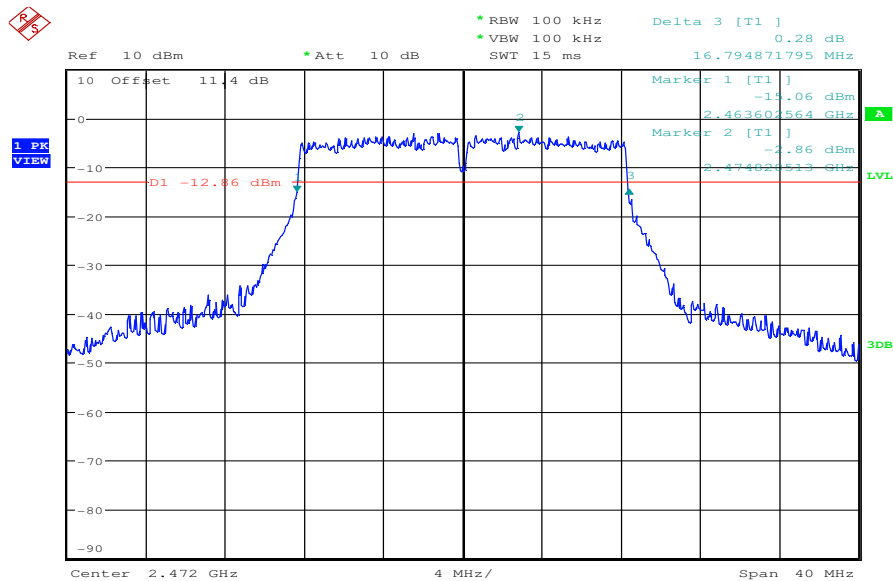

Date: 21.FEB.2011 07:19:01

Plot 6: highest channel, 20 dB bandwidth

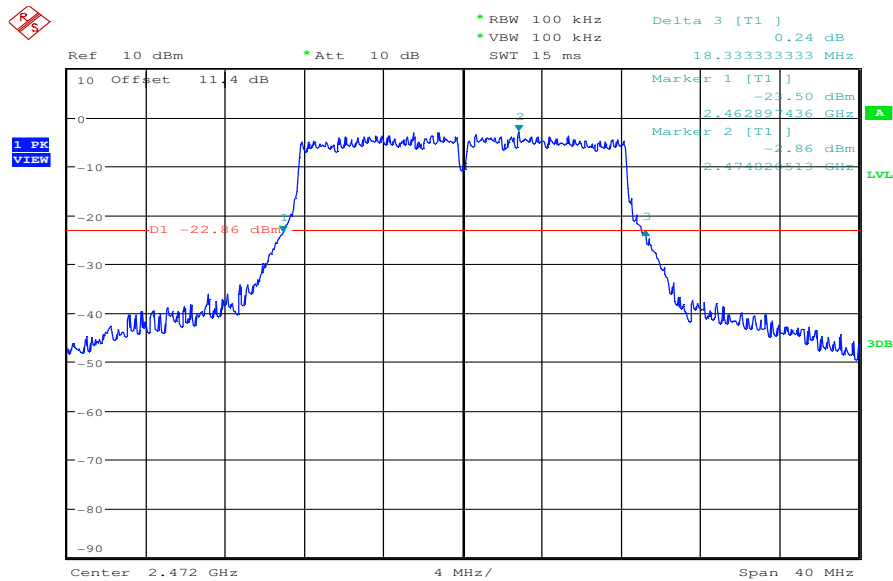

Date: 21.FEB.2011 07:19:41

Plots: OFDM / n – mode, power index 45, MCS7

Plot 1: lowest channel, 10 dB bandwidth

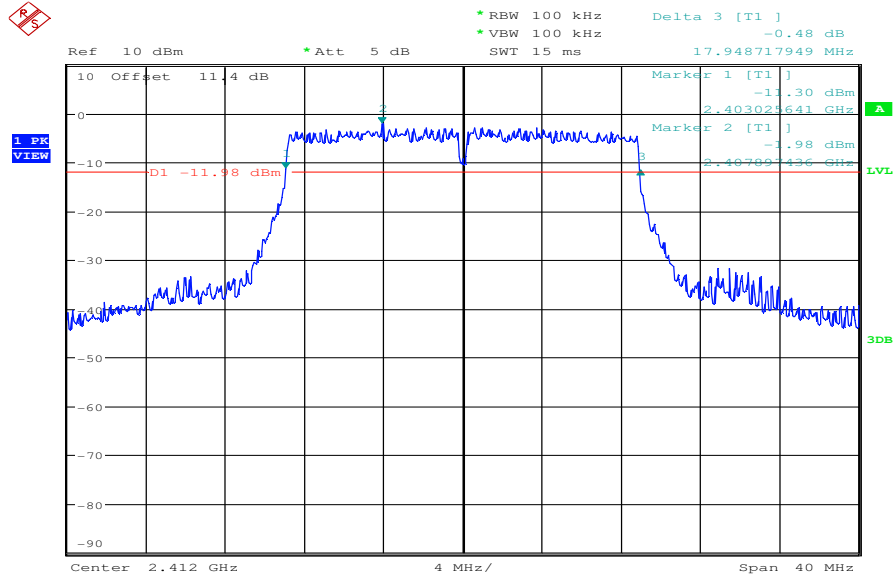

Date: 21.FEB.2011 07:26:19

Plot 2: lowest channel, 20 dB bandwidth

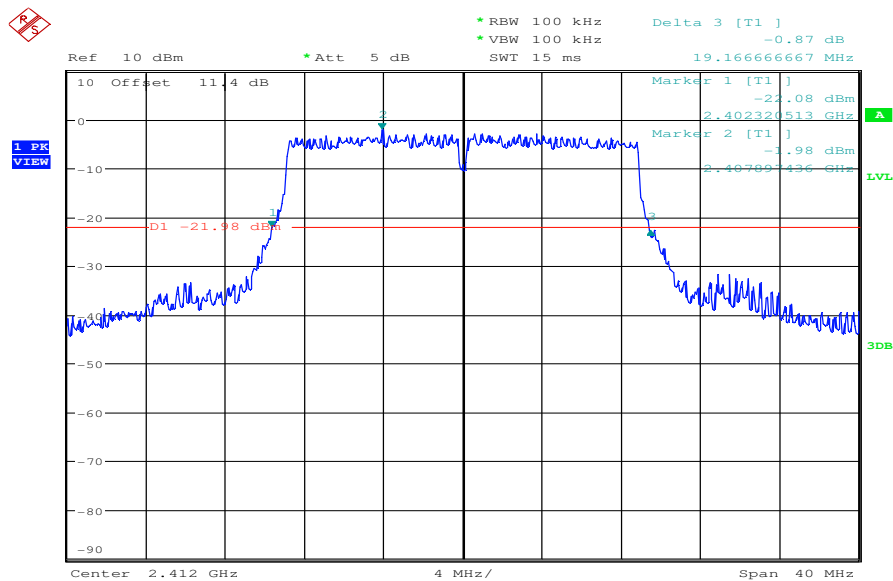

Date: 21.FEB.2011 07:26:53

Plot 3: middle channel, 10 dB bandwidth

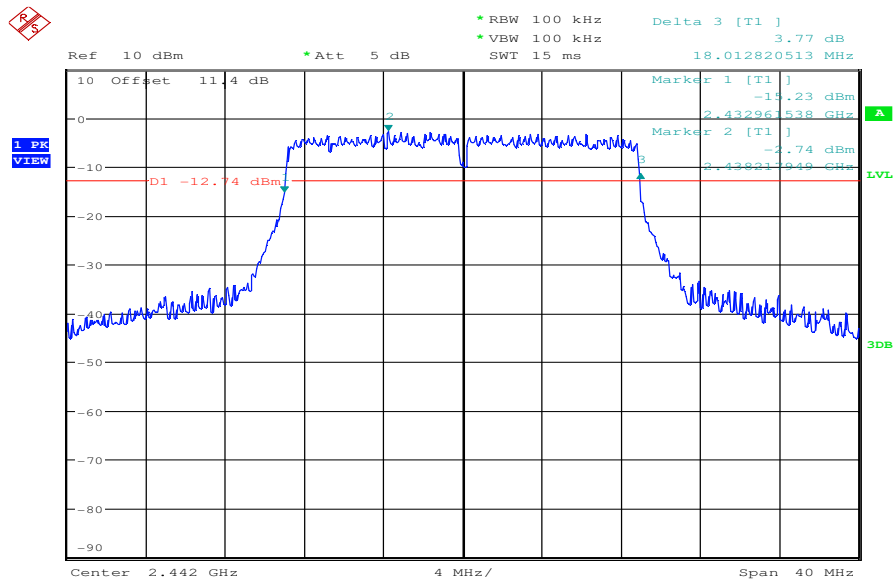

Date: 21.FEB.2011 07:30:21

Plot 4: middle channel, 20 dB bandwidth

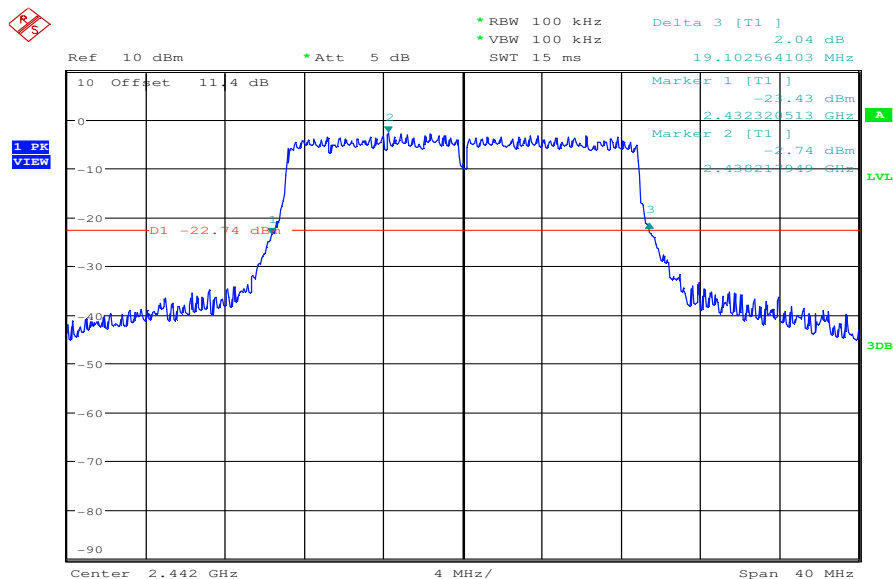

Date: 21.FEB.2011 07:30:55

Plot 5: highest channel, 10 dB bandwidth

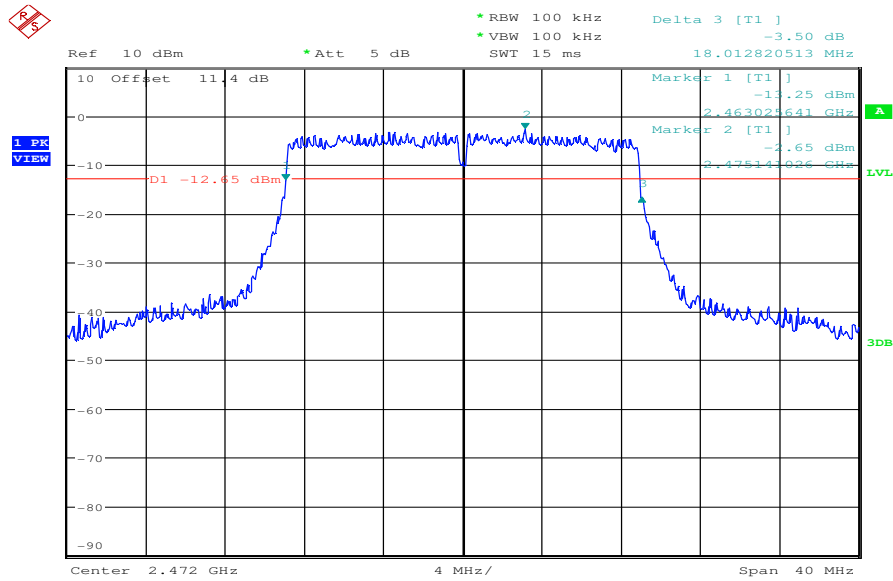

Date: 21.FEB.2011 07:32:44

Plot 6: highest channel, 20 dB bandwidth

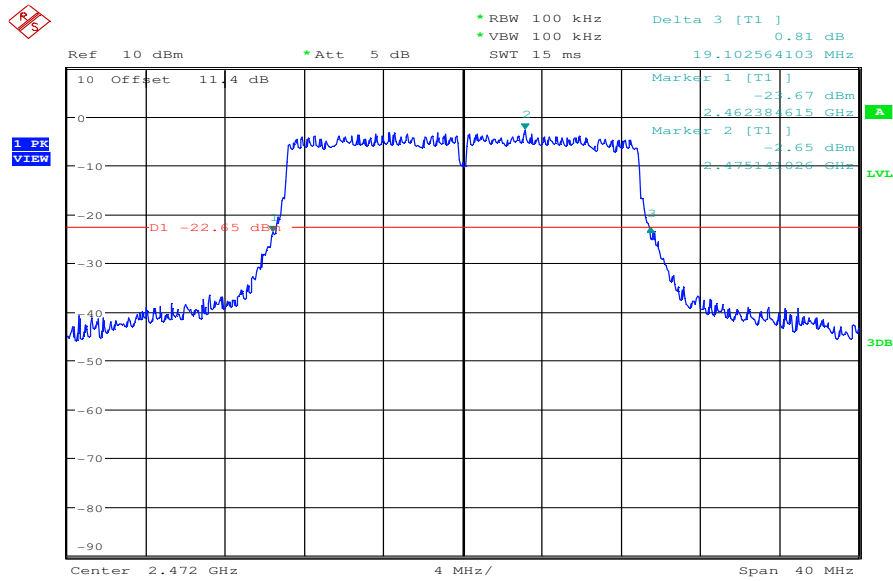

Date: 21.FEB.2011 07:33:43

8.4.7 Spreading factor

> 5 for devices using WLAN Standard

Result: [The result of the measurement is passed.](#)

8.4.8 Staying time

Not applicable – only required for hopping systems

Limit:

Limit	< 400ms
-------	---------

Result: [The result of the measurement is passed.](#)

8.4.9 Dwell time**Measurement parameter:**

Measurement parameter	
Detector:	Positive peak
Sweep time:	34 ms / 2.6 ms
Resolution bandwidth:	3 MHz
Video bandwidth:	10 MHz
Span:	Zero span
Trace-Mode:	View

Limit:

<i>Limit</i>	< 400ms
--------------	---------

Result: [The result of the measurement is passed.](#)

DC correction factor: DSSS / b – mode

Plot 1: Timing

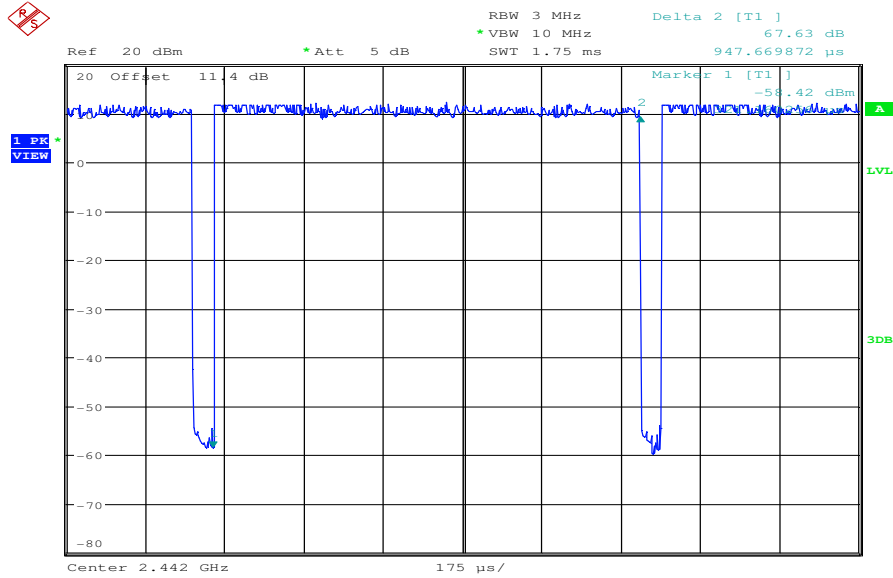

Date: 21.FEB.2011 07:41:05

Plot 2: Timing

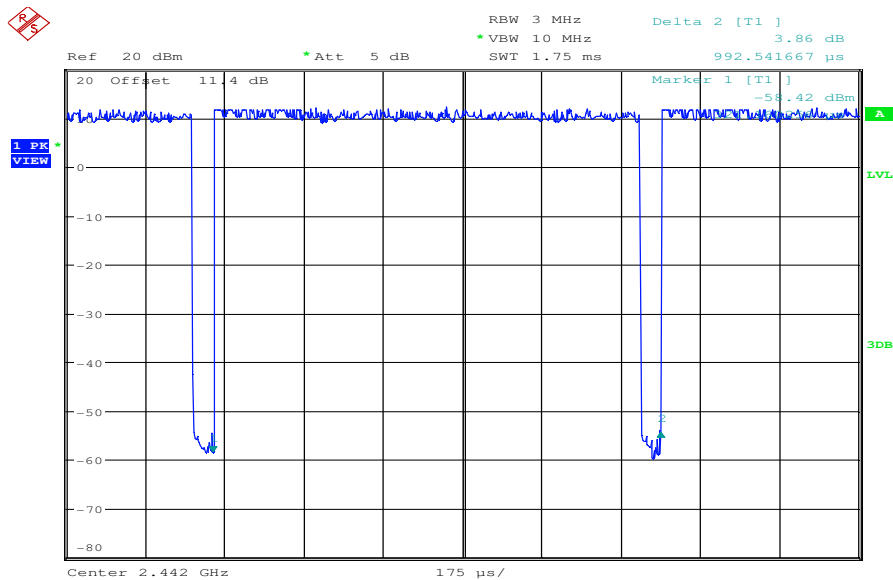

Date: 21.FEB.2011 07:41:26

DC: 95.5 %

DC correction factor: OFDM / g – mode

Plot 1: Timing

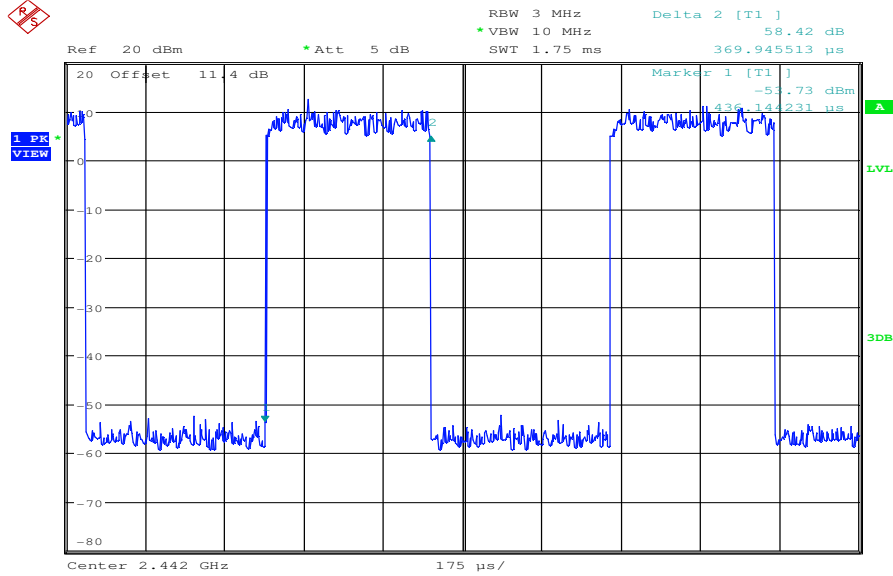

Date: 21.FEB.2011 07:42:47

Plot 2: Timing

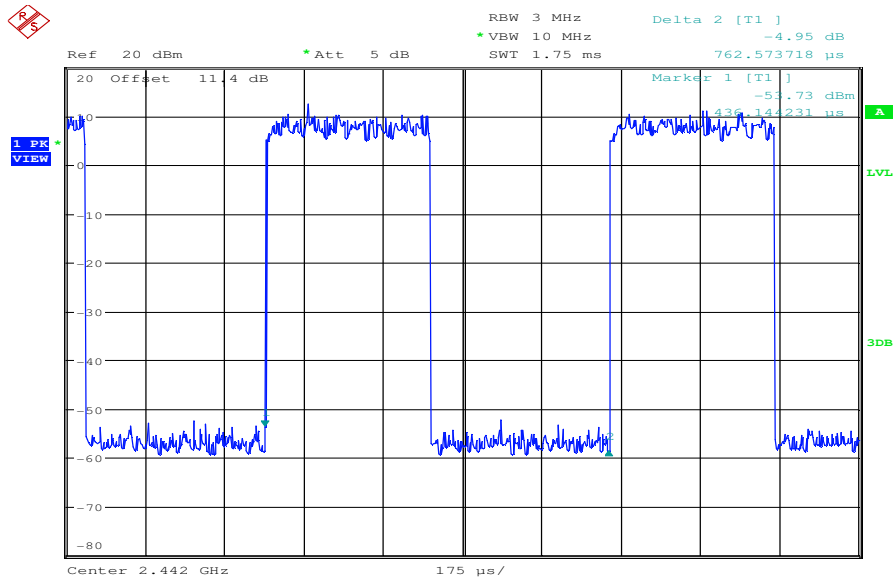

Date: 21.FEB.2011 07:43:08

DC: 48.5 %

DC correction factor: OFDM / n – mode

Plot 1: Timing

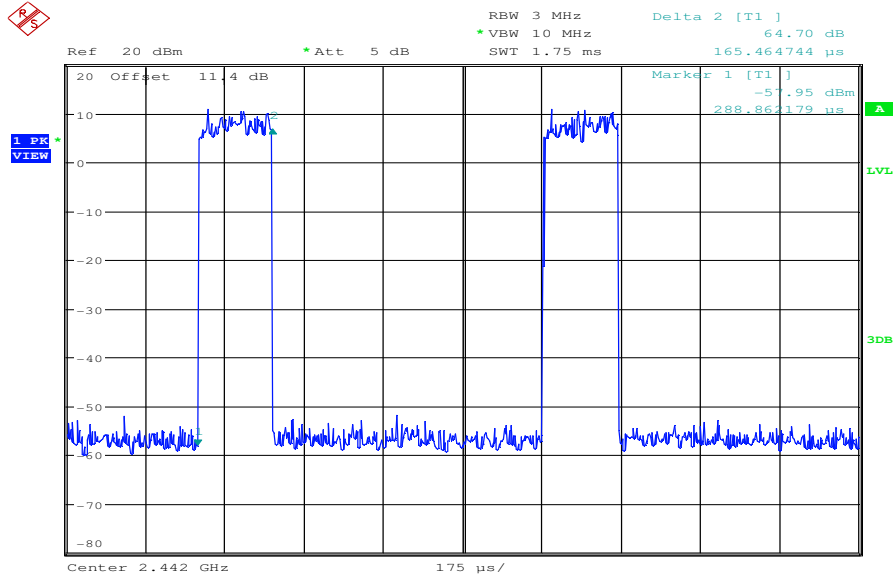

Date: 21.FEB.2011 07:44:27

Plot 2: Timing

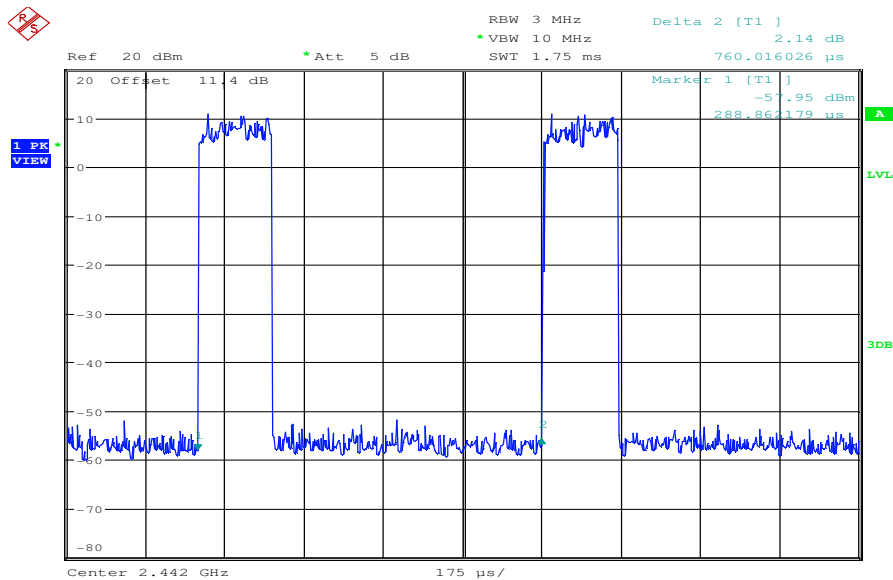

Date: 21.FEB.2011 07:44:45

DC: 21.8 %

8.4.10 Receiver – limit of secondarily emitted radio wave strength - conducted

Measurement parameter:

Measurement parameter	
Detector:	Positive peak
Sweep time:	1s / 12s
Resolution bandwidth:	f <= 1GHz : 1 MHz f > 1GHz : 1 MHz
Video bandwidth:	f <= 1GHz : 10 kHz f > 1GHz : 10 kHz
Span:	See limit!
Trace-Mode:	Max Hold
Additional EUT parameters:	Idle mode

Results:

Receiver mode	
F [MHz]	Level [dBm]
No critical peaks found (see plot).	
Found peaks:	

Limit & Verdict:

Limit	1000 MHz ≥ f : 4 nW 1000 MHz < f : 20 nW
-------	---

Result: The result of the measurement is passed.

Plots:

Plot 1: Idle mode 30 MHz – 1 GHz

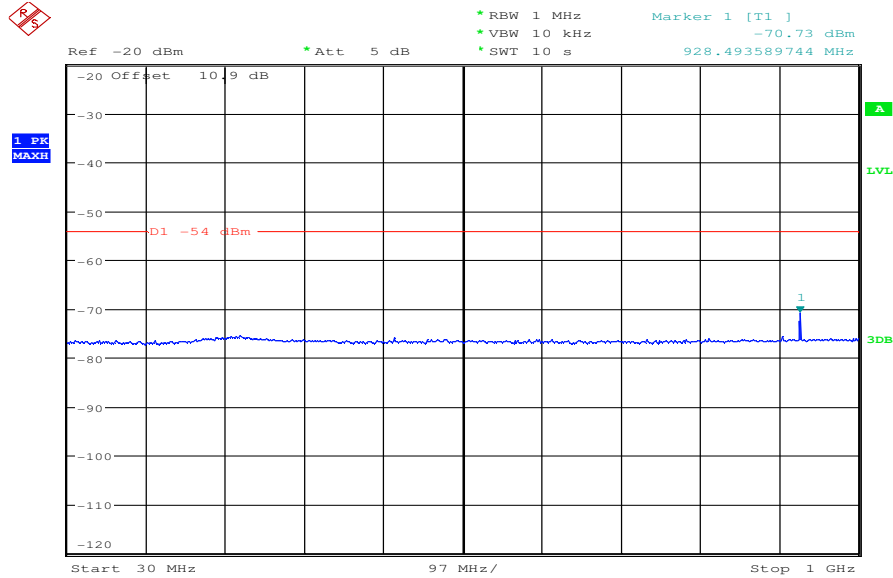

Date: 21.FEB.2011 09:31:51

Plot 2: Idle mode 1 GHz – 12.5 GHz

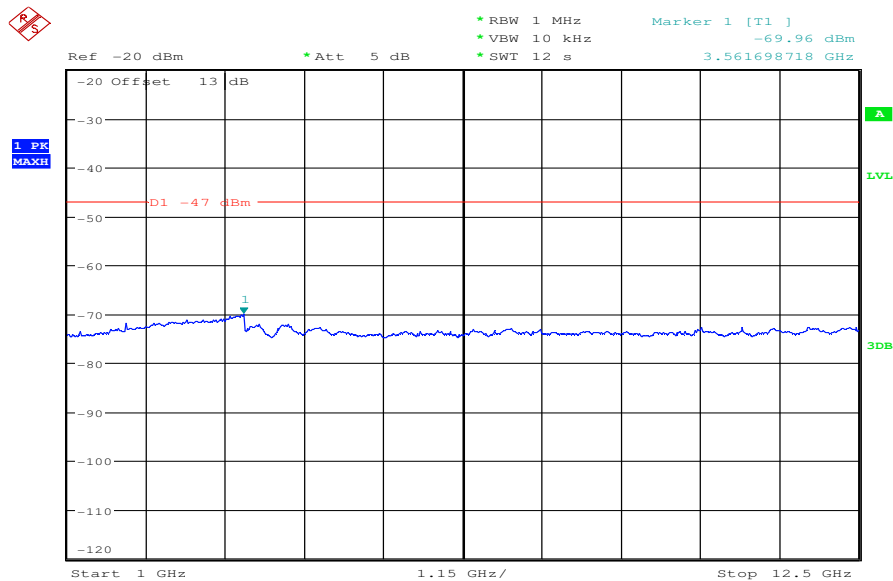

Date: 21.FEB.2011 09:33:34

8.4.11 Receiver – limit of secondarily emitted radio wave strength - radiated

Measurement parameter:

Measurement parameter	
Detector:	Positive peak
Sweep time:	Auto
Resolution bandwidth:	f <= 1GHz : 100 kHz f > 1GHz : 1 MHz
Video bandwidth:	f <= 1GHz : 100 kHz f > 1GHz : 1 MHz
Span:	100 MHz steps
Trace-Mode:	Max Hold
Additional EUT parameters:	Idle mode

Results:

Receiver mode	
F [MHz]	Level [dBm]
No critical peaks found (see plot).	
Found peaks:	

Limit & Verdict:

Limit	1000 MHz ≥ f : 4 nW 1000 MHz < f : 20 nW
-------	---

Result: The result of the measurement is passed.

Plots: Idle / RX – mode

Plot 1: Idle / RX – mode, up to 1 GHz, vertical

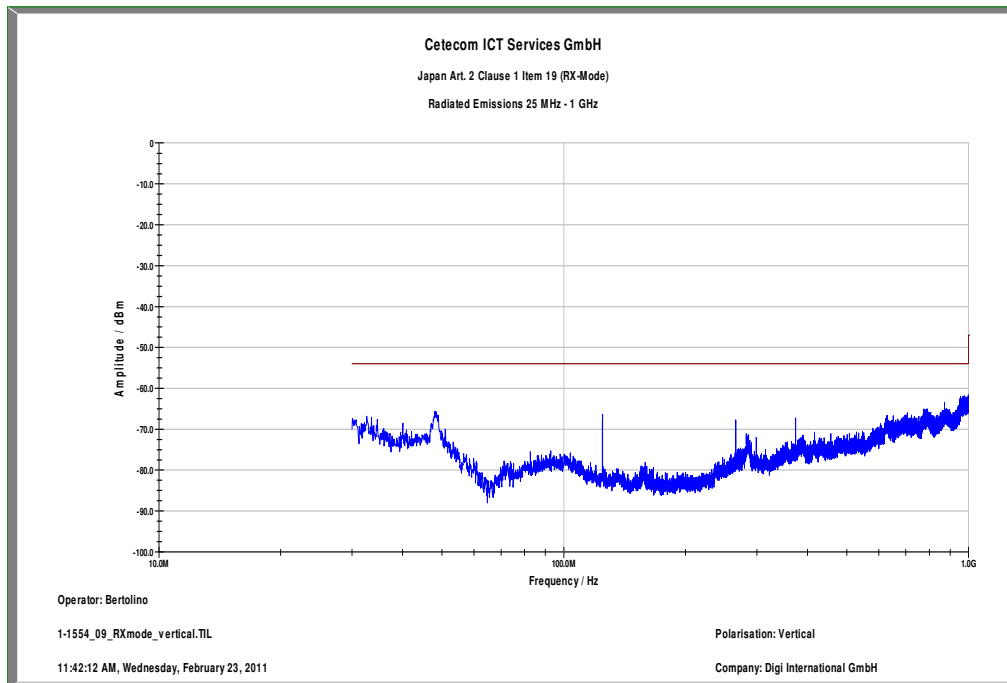

Plot 2: Idle / RX – mode, 1 GHz to 12.75, vertical

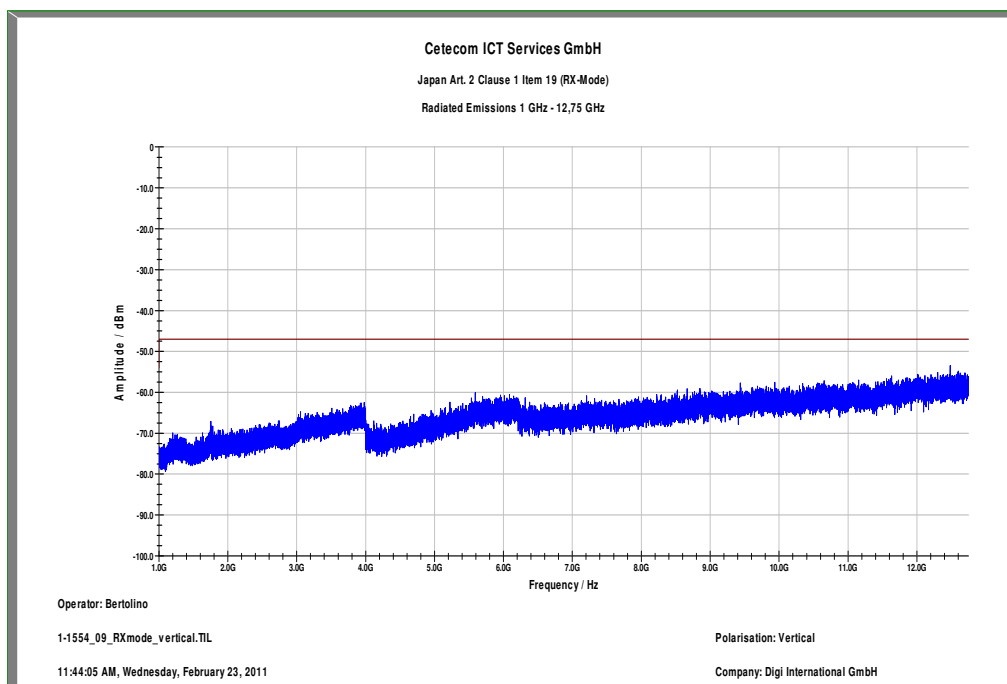

Plot 3: Idle / RX – mode, up to 1 GHz, horizontal

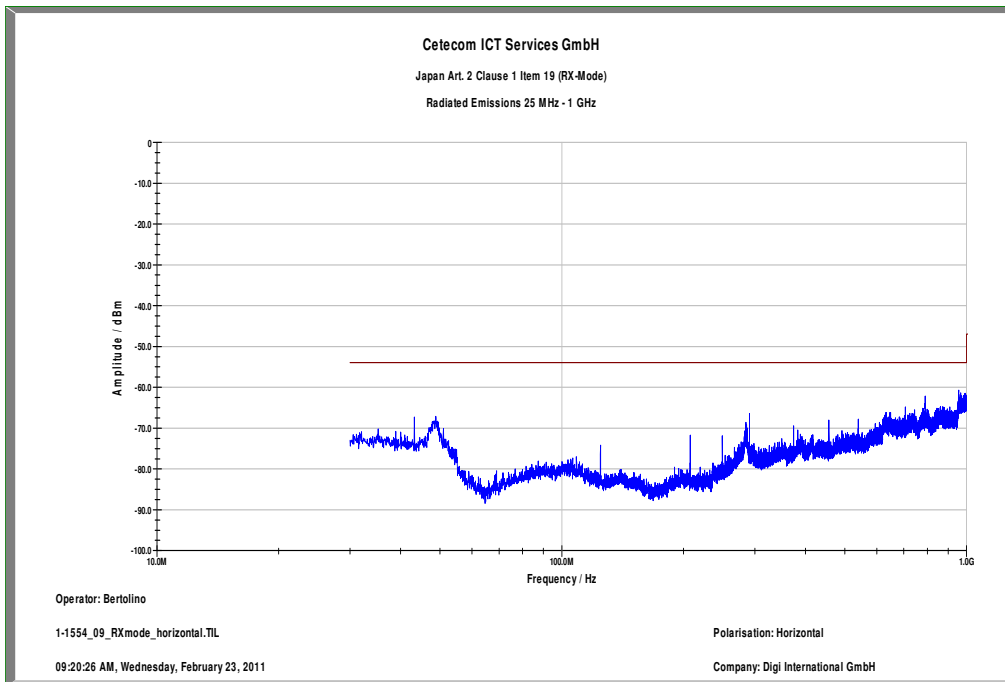

Plot 4: Idle / RX – mode, 1 GHz to 12.75, horizontal

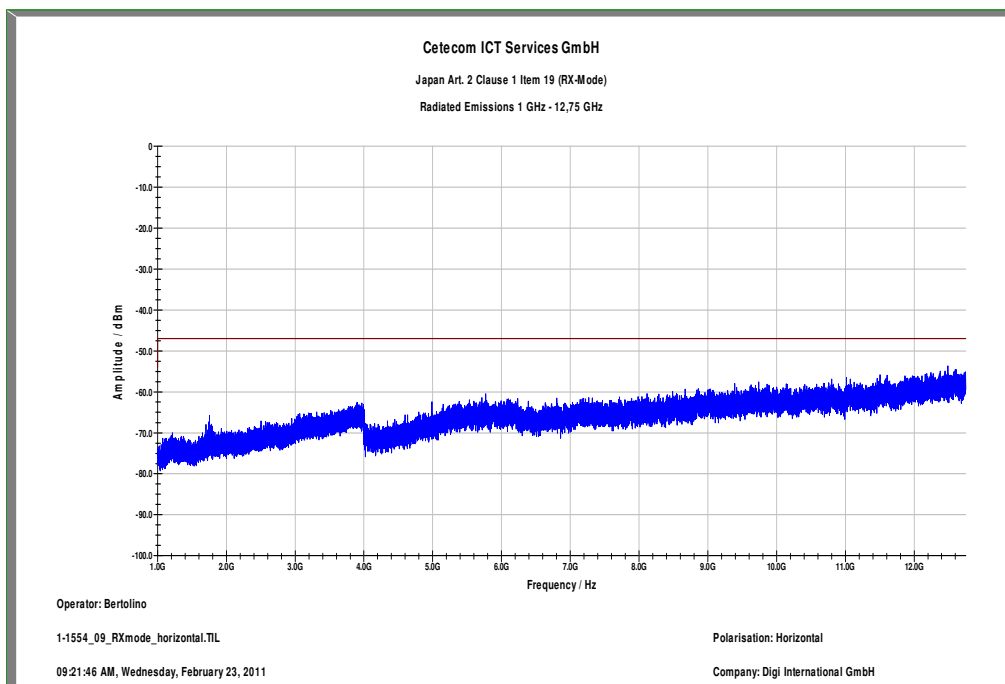

8.4.12 Interference prevention function

Interference Prevention Function:

(Article 9.4): Via Identification Code unexpected login incidences to extraneous receivers are avoided

Result: The result of the measurement is passed.

8.4.13 Carrier sensing function

Carrier sensing function:

The sample does not transmit or stop transmission when detecting an interferer in the same transmitting channel.

Result: The result of the measurement is passed.

8.4.14 Enclosure requirements

Not applicable! The EUT is a WLAN module without housing!

Result: -/-

9 Test equipment and ancillaries used for tests

Typically, the calibrations of the test apparatus are commissioned to and performed by an accredited calibration laboratory. The calibration intervals are determined in accordance with the DIN EN ISO/IEC 17025. In addition to the external calibrations, the laboratory executes comparison measurements with other calibrated test systems or effective verifications. Weekly chamber inspections and range calibrations are performed. Where possible, rf-generating and signalling equipment as well as measuring receivers and analyzers are connected to an external high-precision 10 MHz reference (GPS-based or rubidium frequency standard).

In order to simplify the identification of the equipment used at some special tests, some items of test equipment and ancillaries can be provided with an identifier or number in the equipment list below (Labor/Item).

No.	Lab / Item	Equipment	Type	Manufact.	Serial No.	INV. No Cetecom	Kind of Calibration	Last Calibration	Next Calibration
1	n. a.	Anechoic chamber	FAC 3/5m	MWB / TDK	87400/02	300000996		23.03.2009	
2	n. a.	Relais Matrix	PSU	R&S	890167/024	300001168	ne		
3	n. a.	Amplifier	js42-00502650-28-5a	Parzich GMBH	928979	300003143	ne		
4	n. a.	Band Reject filter	WRCG2400/2483-2375/2505-50/10SS	Wainwright	11	300003351	ev		
5	n. a.	TILE-Software Emission	Quantum Change, Modell TILE-ICS/FULL	EMCO	none	300003451	ne		
6	n. a.	PSA Spectrum Analyzer 3 Hz - 26.5 GHz	E4440A	Agilent Technologies	MY48250080	300003812	k	08.09.2010	08.09.2012
7	n. a.	RF Filter Section 9kHz - 1GHz	N9039A	Agilent Technologies	MY48260003	300003825	viKI!	08.09.2010	08.09.2012
8	n. a.	TRILOG Broadband Test-Antenna 30 MHz - 3 GHz	VULB9163	Schwarzbeck	371	300003854	viKI!	17.12.2008	17.12.2011
9	n. a.	Splitter	15542	Mini Circuits	15542	400000086	ev		
10	n. a.	Splinter	42000	Anaren	4730	400000085	ev		
11	n. a.	Switch Unit	TS-RSP	R&S	100155	300003281	ev		
12	n. a.	Mount kit für Laptop		EMCO/2		300003295	ne		
13	n. a.	Hygro-Thermometer	-/, 5-45°C, 20-100%rF	Thies Klima	-/	400000089	k	04.05.2010	04.05.2011
14	n. a.	CTIA-Chamber	AMS 8500	ETS-Lindgren Finland		300003327-0000	ne		
15	n. a.	CTIA-Chamber - Positioning Equipment	CTIA-Chamber - Positioning Equipment	EMCO/2		300003328-0000	ne		
16	n. a.	Limiting Amplifier (Microwave Amplifier)	LA 02-801	JCA Technology	101	300003341	ne		
17	n. a.	Spectrum Analyzer 9kHz - 30 GHz	FSP30	R&S	100623	300003464	Ve	25.06.2010	25.06.2012
18	n. a.	Relaisplatte TS-ENGP	TS-ENGP, 6 Stk 18 GHz als Erweiterung g zu TS-RSP	R&S	-/	300003591	ne		
19	n. a.	Conical Log-Spiral Antenna Software	3102	ETS-LINDGREN	00091823	300003849	NK!	30.10.2008	
20	n. a.	Lizenz Paket AMS-32 + Option für OTA Messsoftw	AMS32-VUS + AMS32-K28	R&S	101425 + 101424	300003959	ne		
21	n. a.	Offene Schalt- und Steuerplattform für Testsystem Autom	OSP120	R&S	100083	300003957	ne		
22	n. a.	Spectrum Analyzer 20 Hz - 50 GHz	FSU50	R&S	200012	300003443	ve	01.07.2010	01.07.2012
23	n. a.	Spectrum Analyzer 9kHz to 30GHz - 140..+30dBm	FSP30	R&S	100886	300003575	k	07.09.2010	07.09.2012

Agenda: Kind of Calibration

k	calibration / calibrated	EK	limited calibration
ne	not required (k, ev, izw, zw not required)	zw	cyclical maintenance (external cyclical maintenance)
ev	periodic self verification	izw	internal cyclical maintenance
Ve	long-term stability recognized	g	blocked for accredited testing
vkI!	Attention: extended calibration interval		
NK!	Attention: not calibrated	*)	next calibration ordered / currently in progress

Annex A Photographs of the test setup

Photo documentation:

Photo 1: chamber C

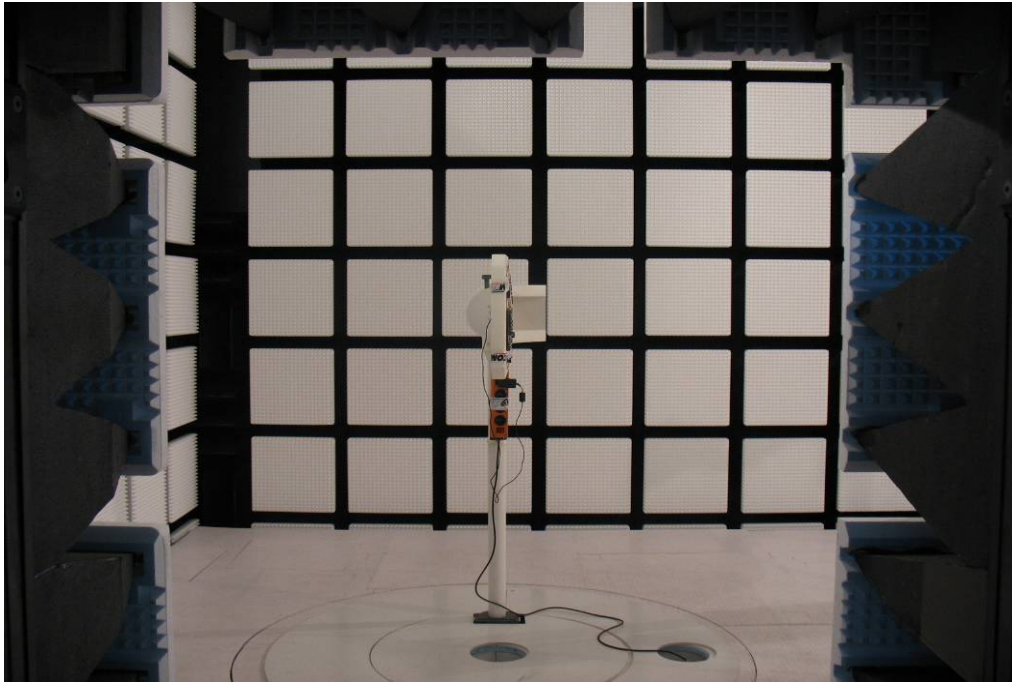

Photo 2: chamber C

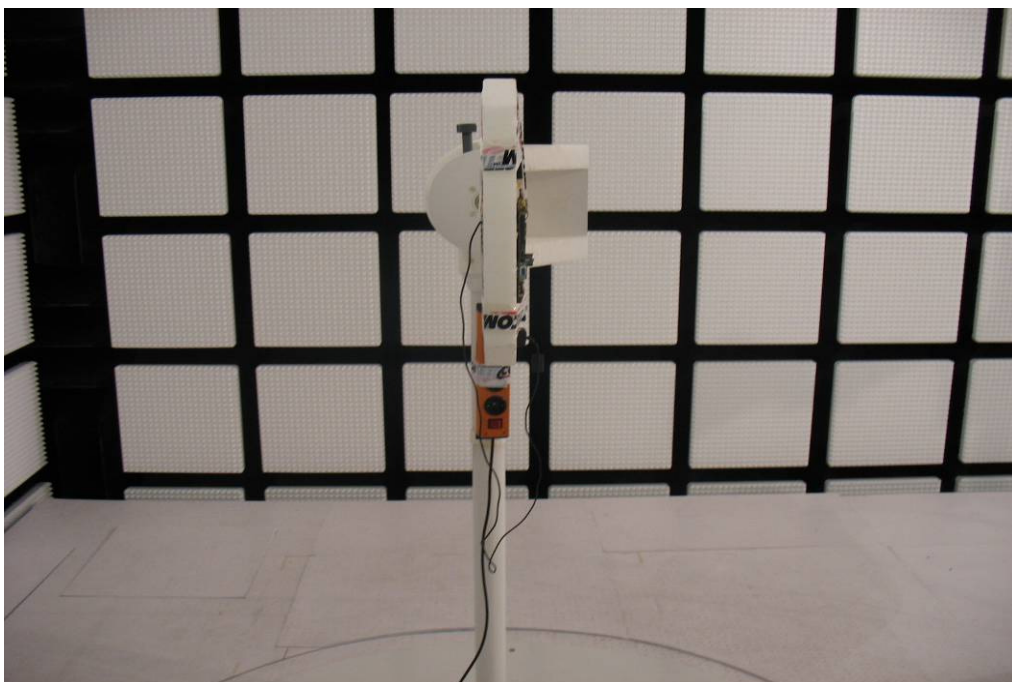

Photo 3: chamber C

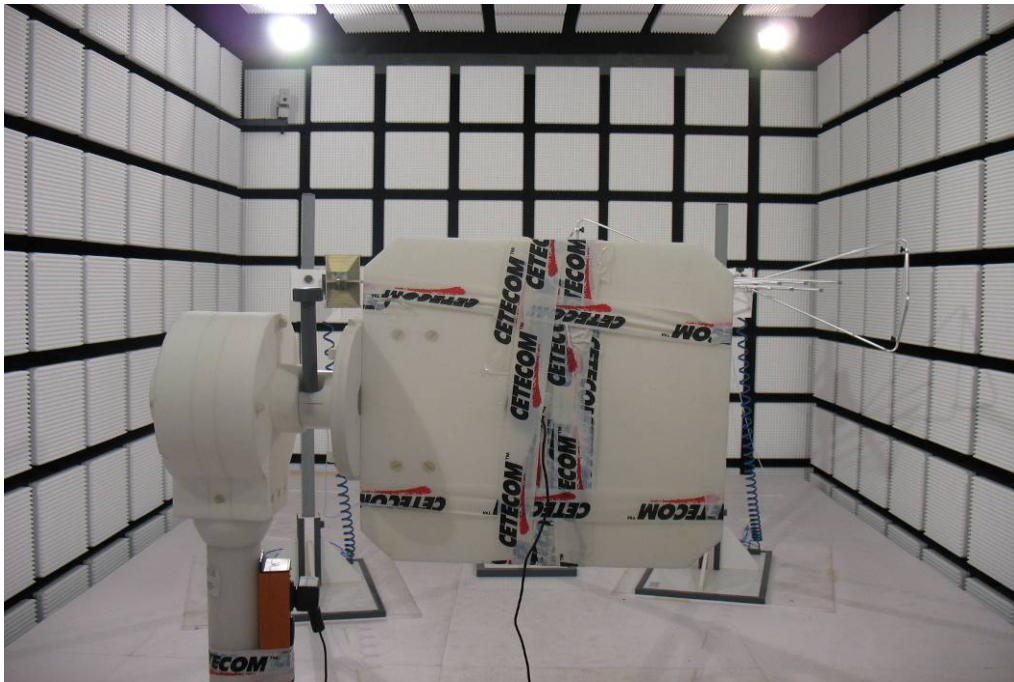

Photo 4: chamber C



Photo 5: chamber C

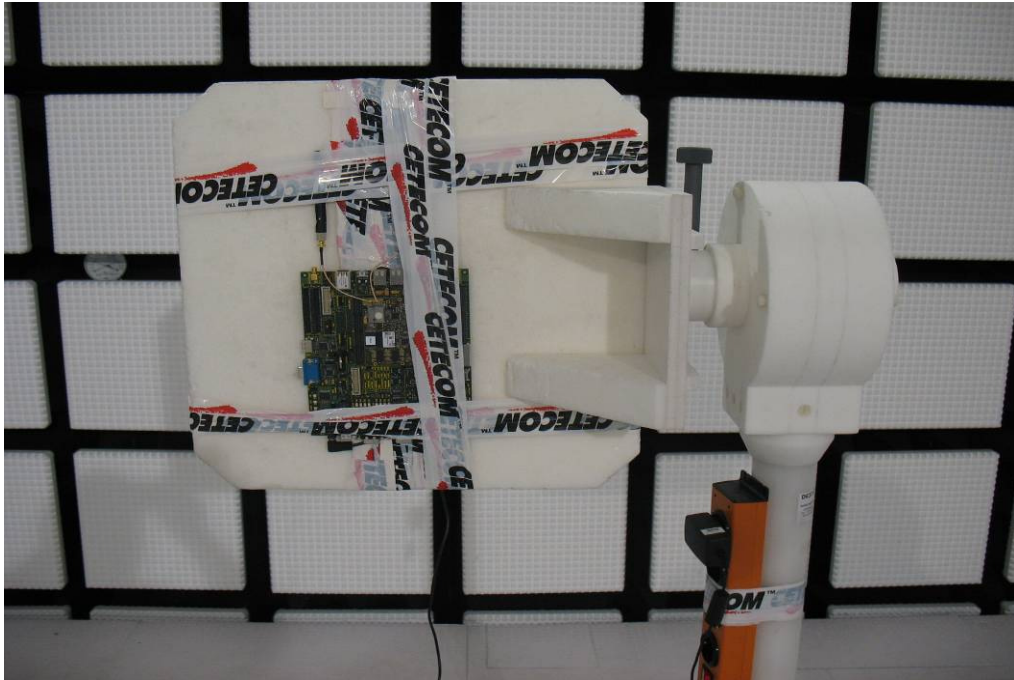

Photo 6: chamber C



Photo 7: chamber C

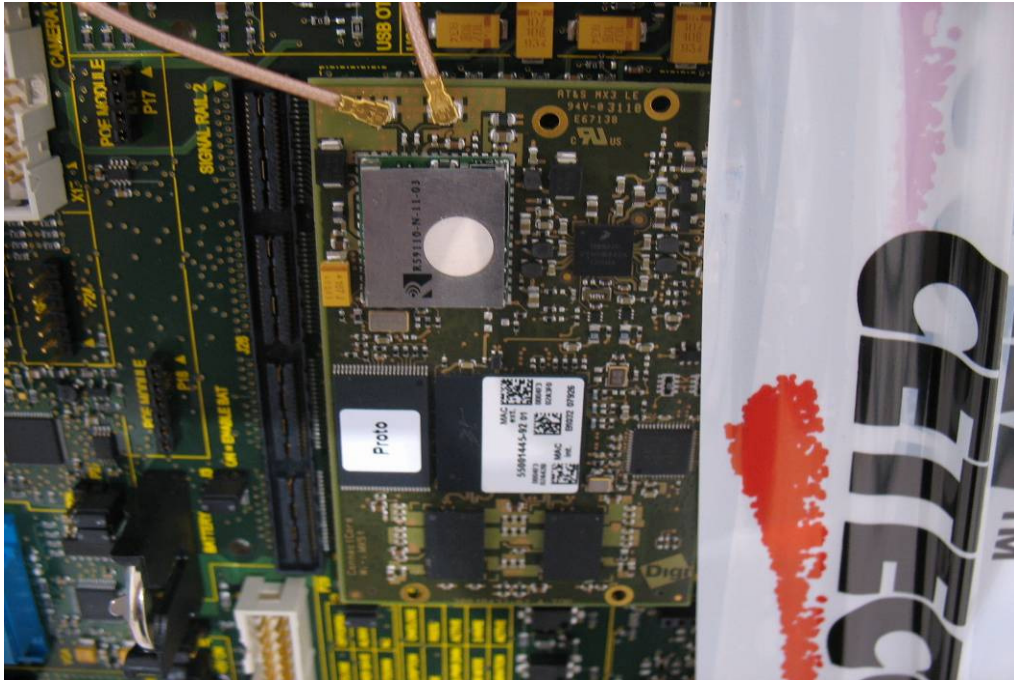

Photo 8: OTA chamber

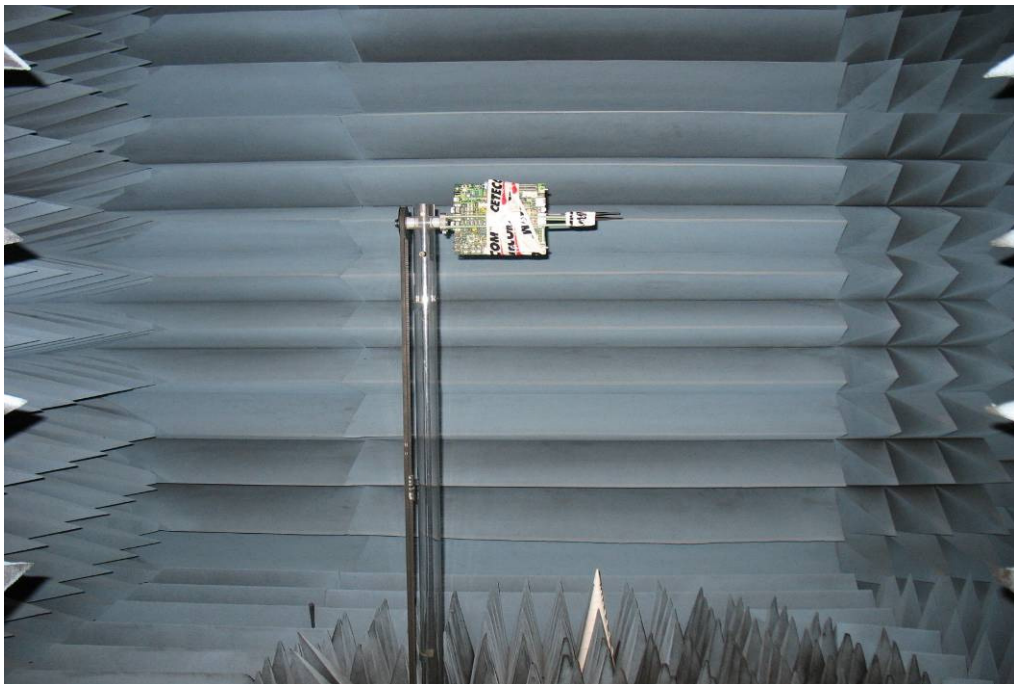
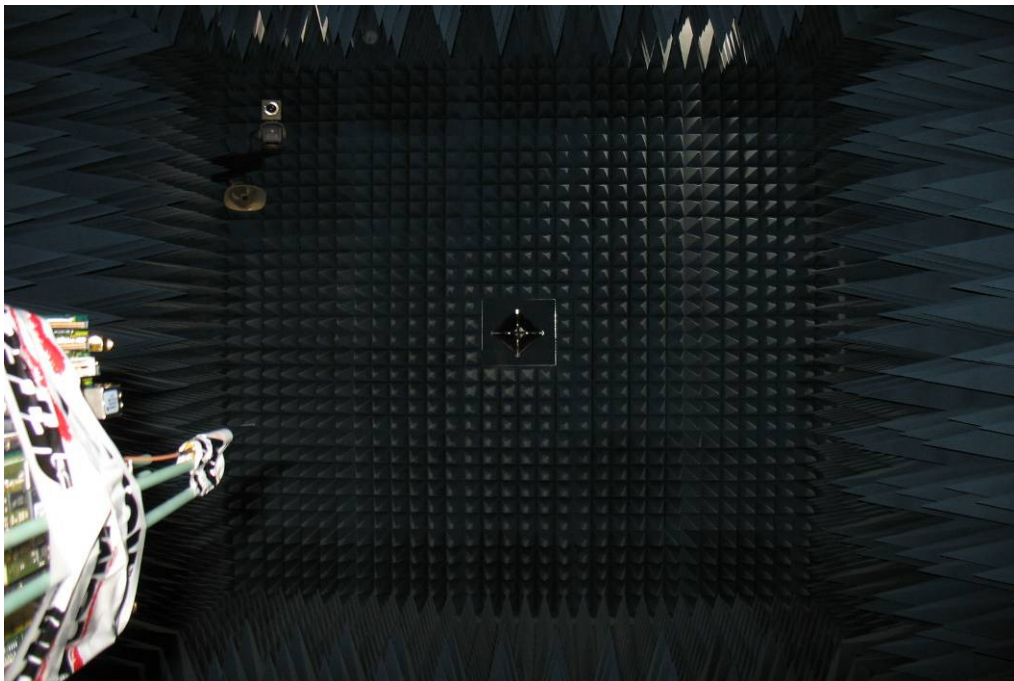

Photo 9: OTA chamber



Photo 10: OTA chamber



Annex B External photographs of the EUT

Photo documentation:

Photo 1: evaluation board with WLAN module

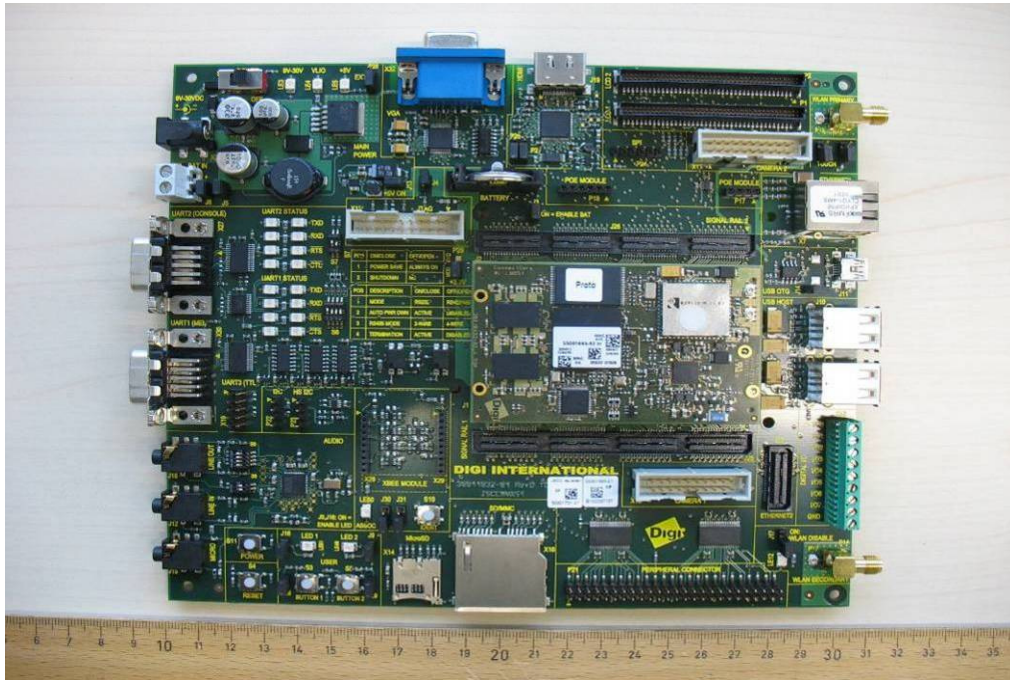

Photo 2: evaluation board with WLAN module

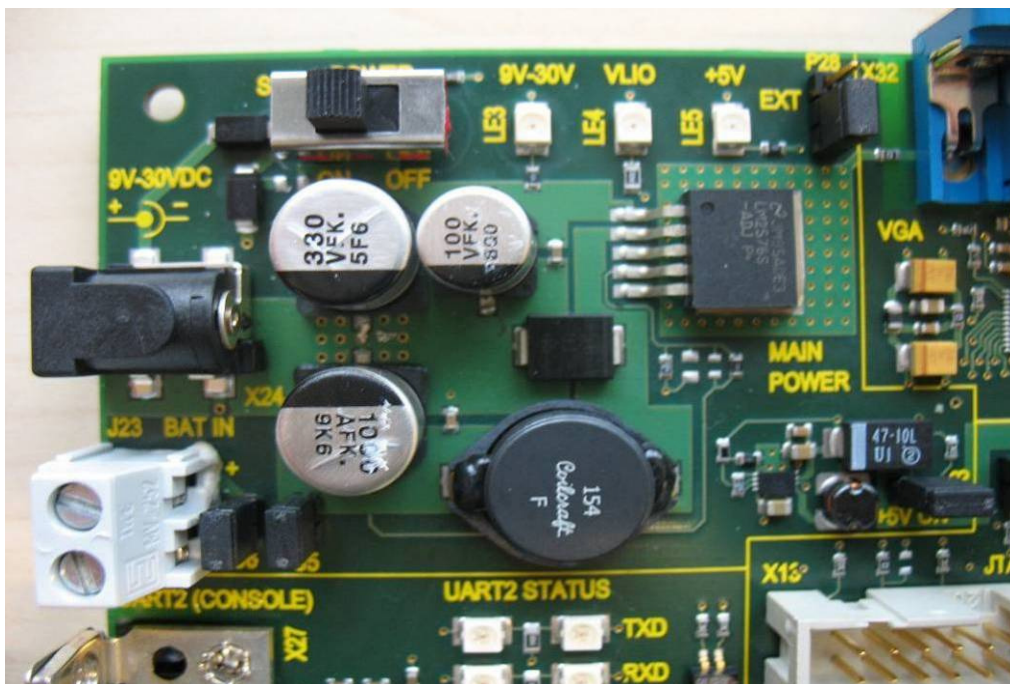

Photo 3: evaluation board with WLAN module

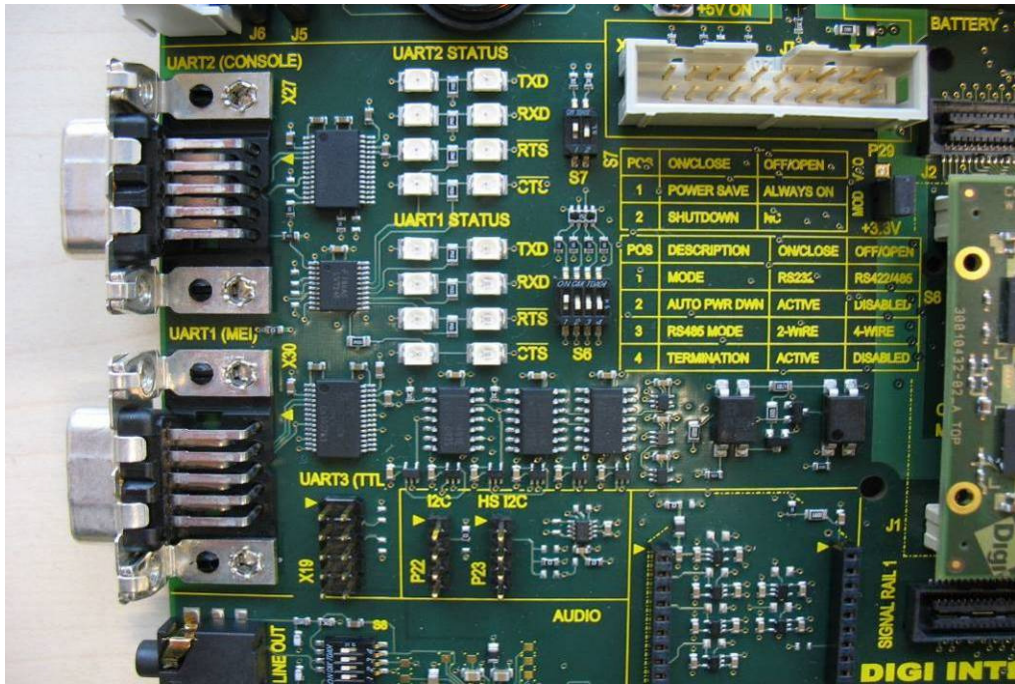

Photo 4: evaluation board with WLAN module

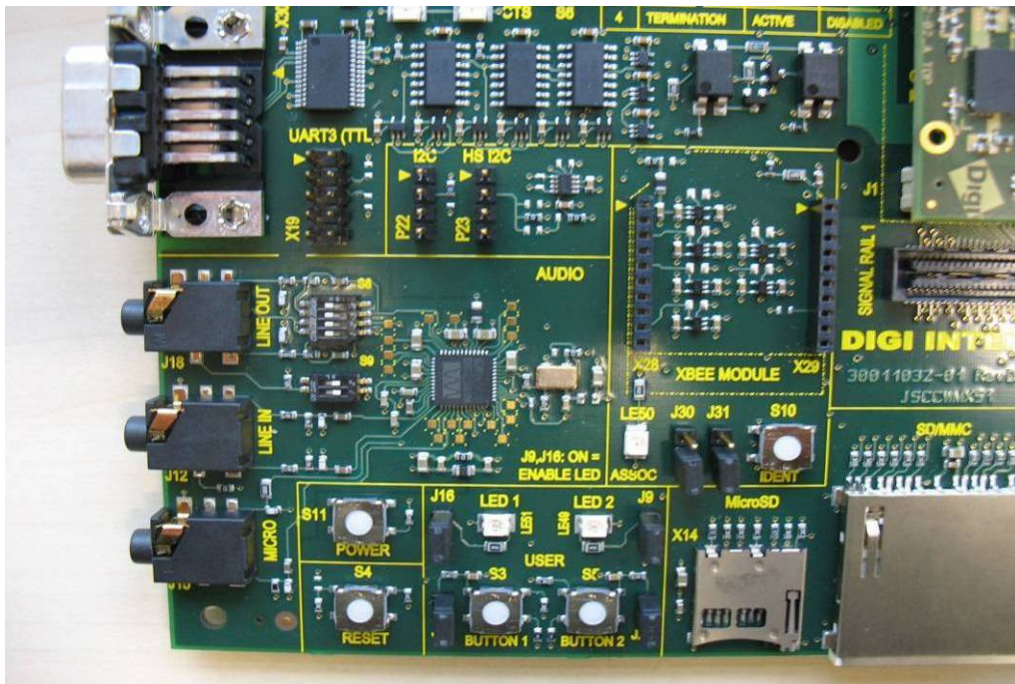

Photo 5: evaluation board with WLAN module



Photo 6: evaluation board with WLAN module

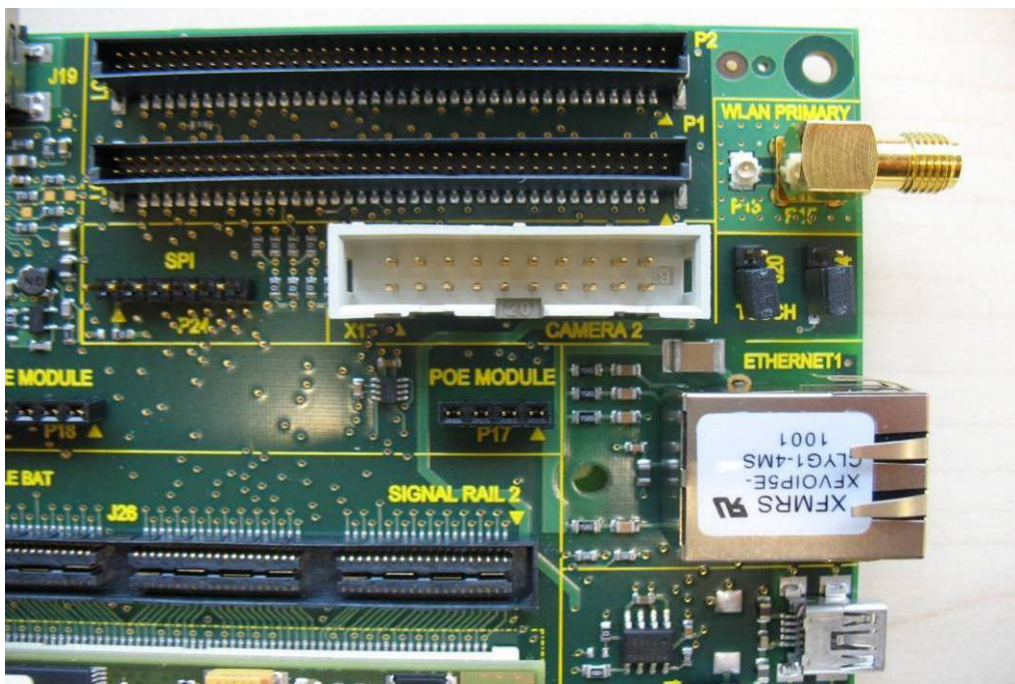

Photo 7: evaluation board with WLAN module

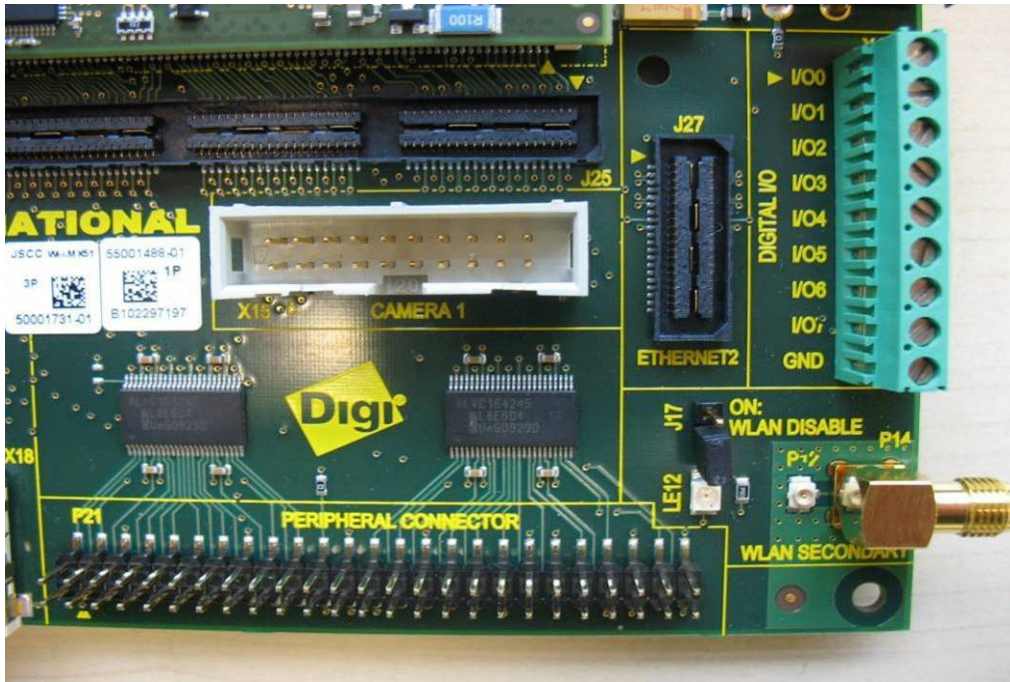

Photo 8: evaluation board with WLAN module



Photo 9: evaluation board with WLAN module



Photo 10: WLAN module

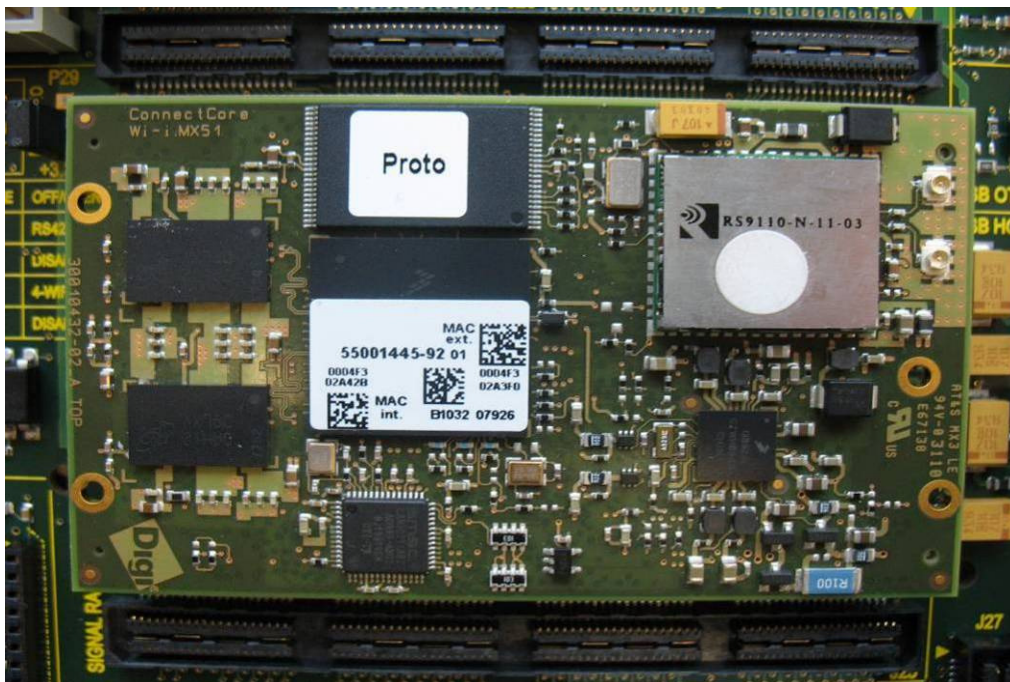

Photo 11: WLAN module



Photo 12: WLAN module



Photo 13: WLAN module, antenna ports RX and TX

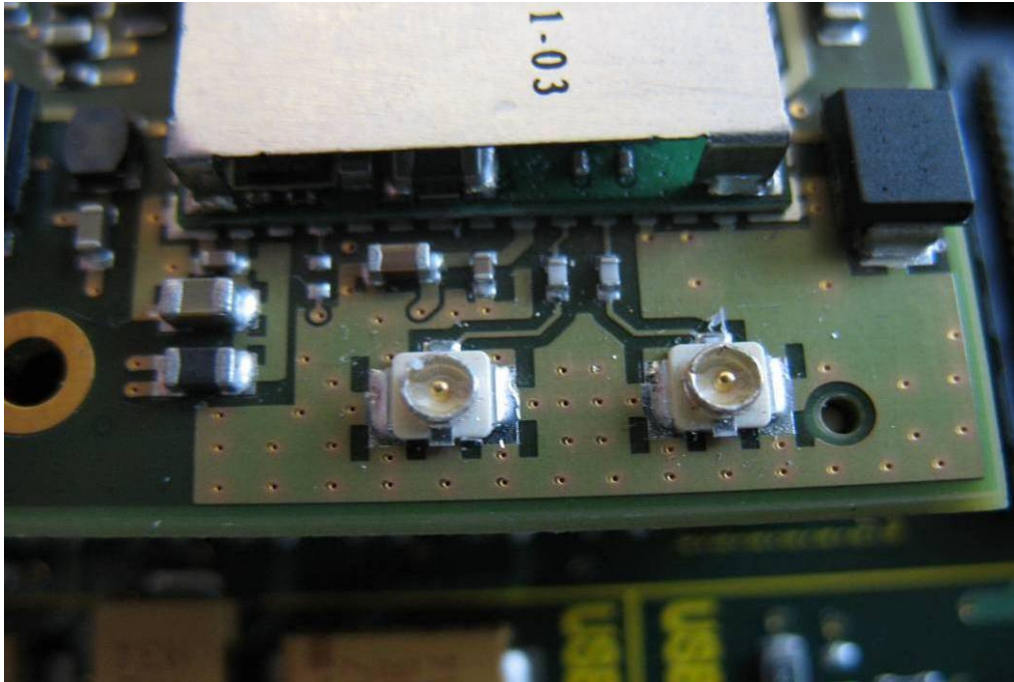

Photo 14: WLAN module



Photo 15: antenna

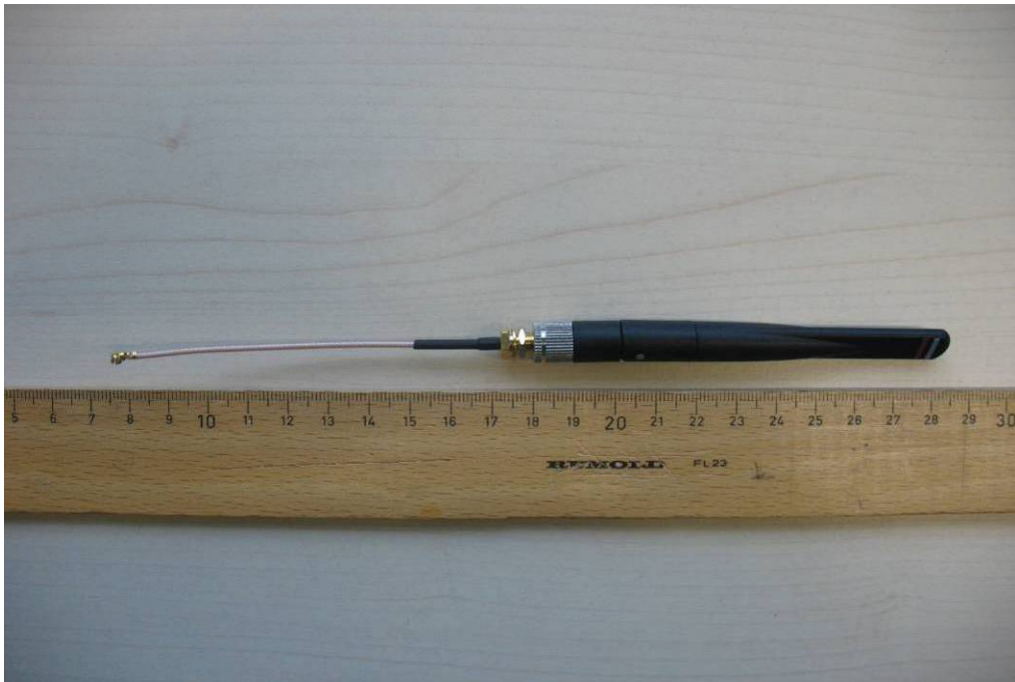

Photo 16: power supply



Photo 17: power supply



Photo 18: power supply



Photo 19: power supply



Photo 20: power supply



Photo 21: power supply



Annex C Internal photographs of the EUT

Photo documentation:

Photo 1: evaluation board

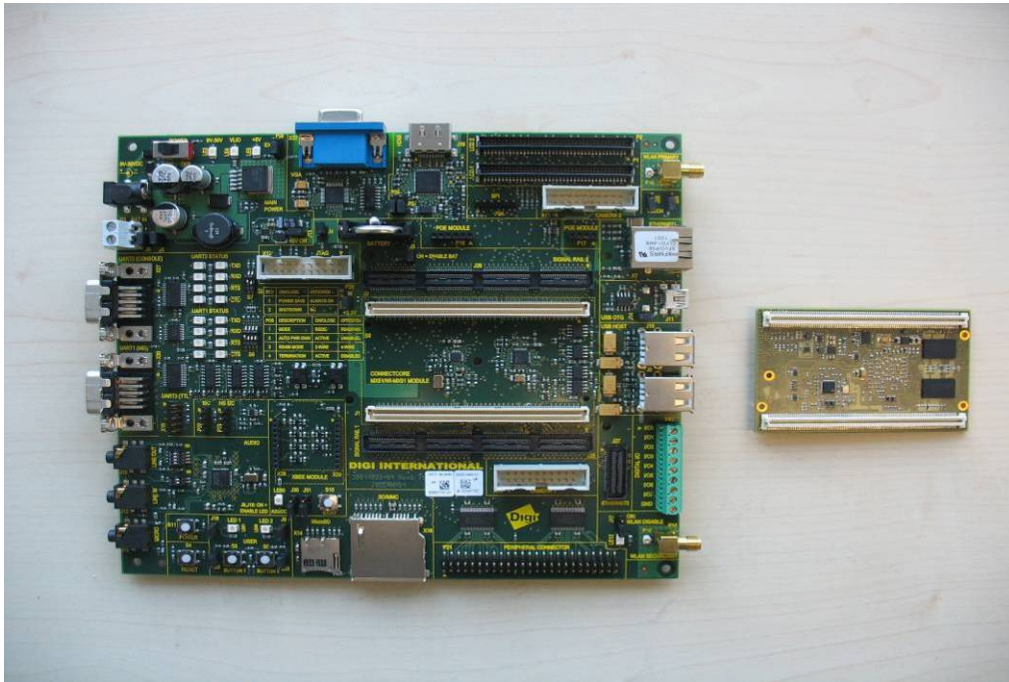

Photo 2: evaluation board

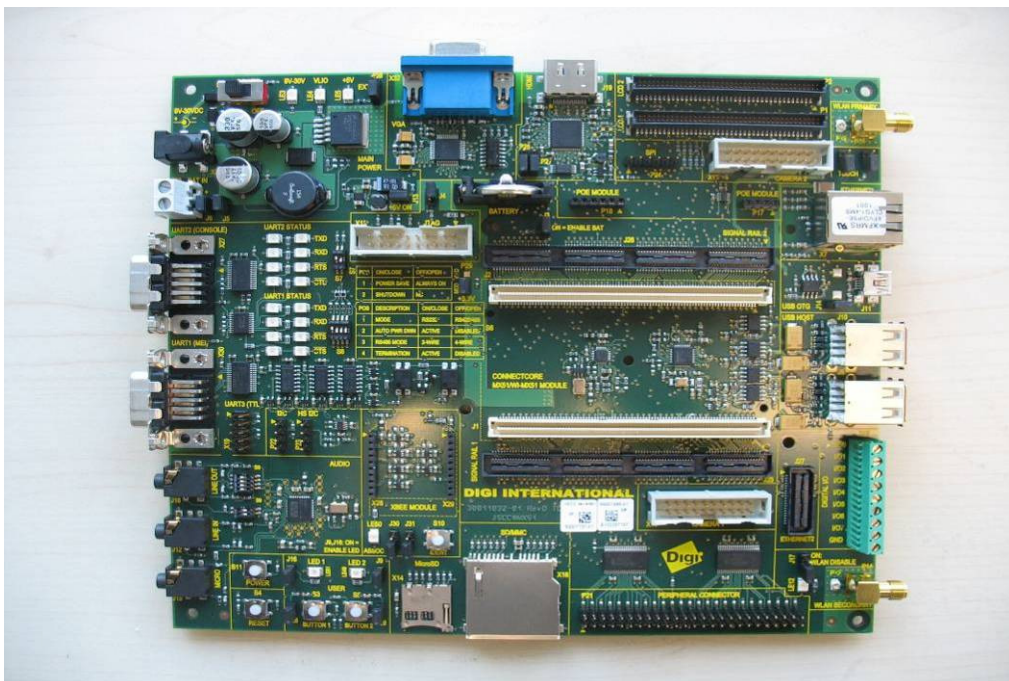

Photo 3: evaluation board

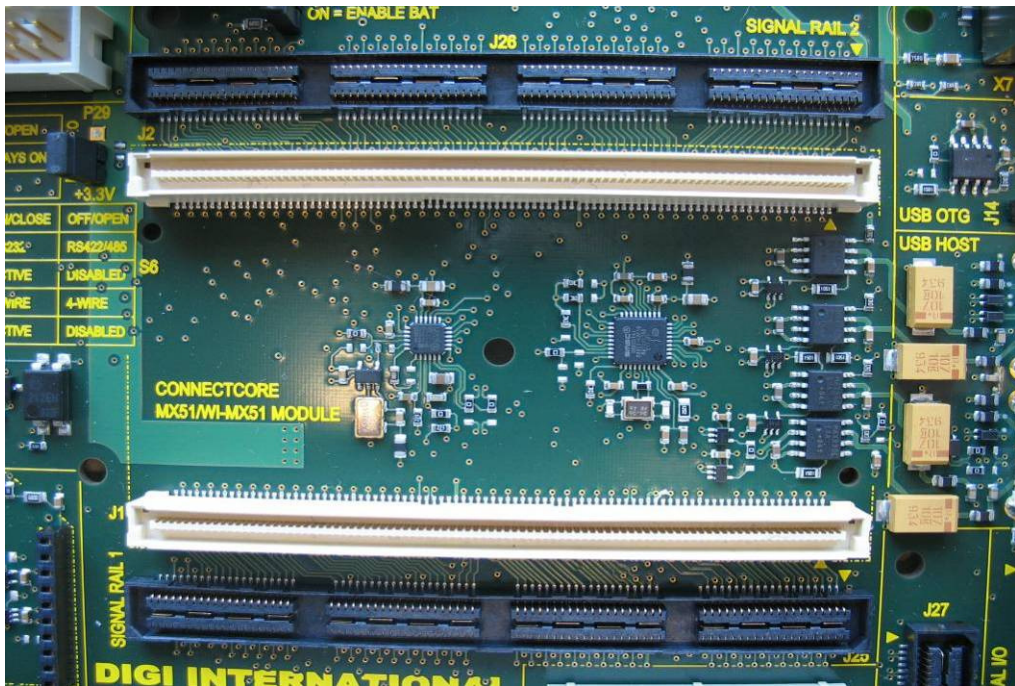

Photo 4: WLAN module / back side

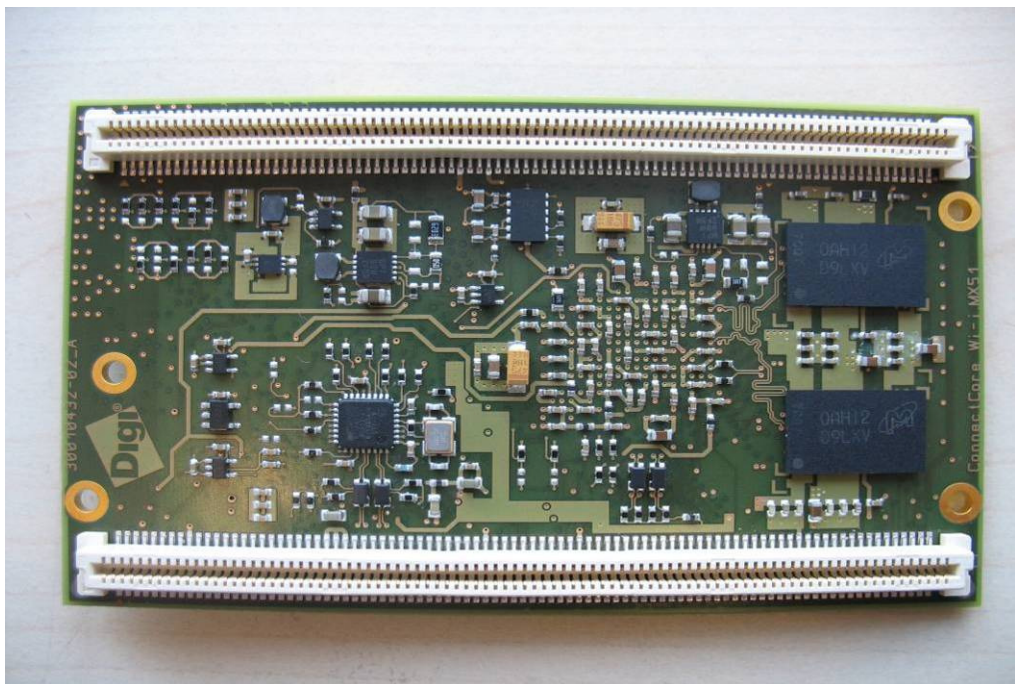

Photo 5: WLAN module / front side

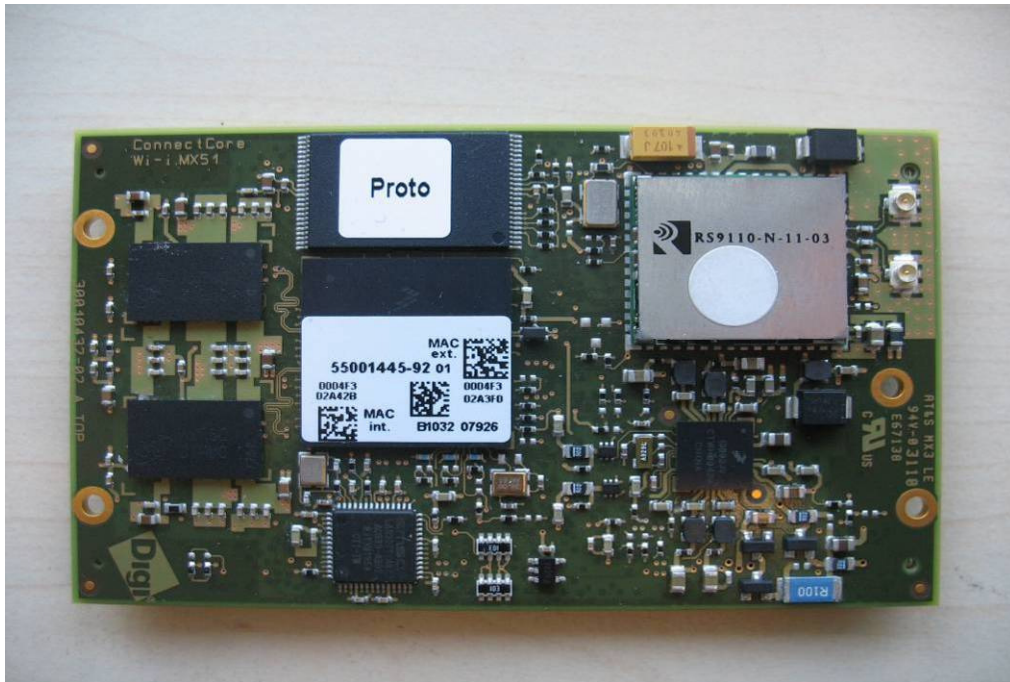

Photo 6: WLAN module / front side without shielding

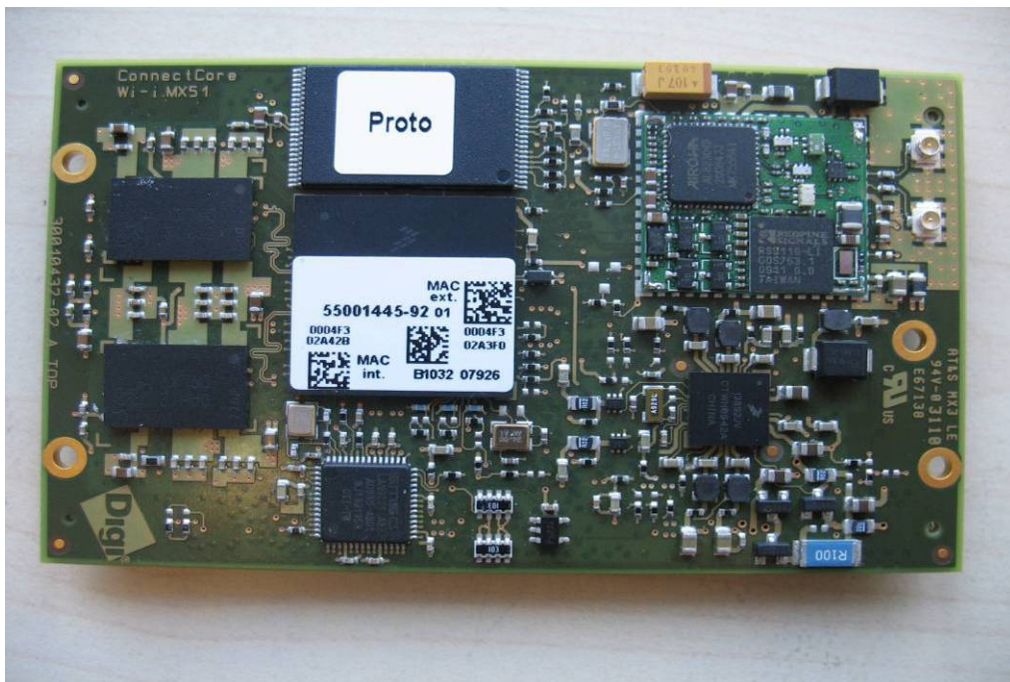
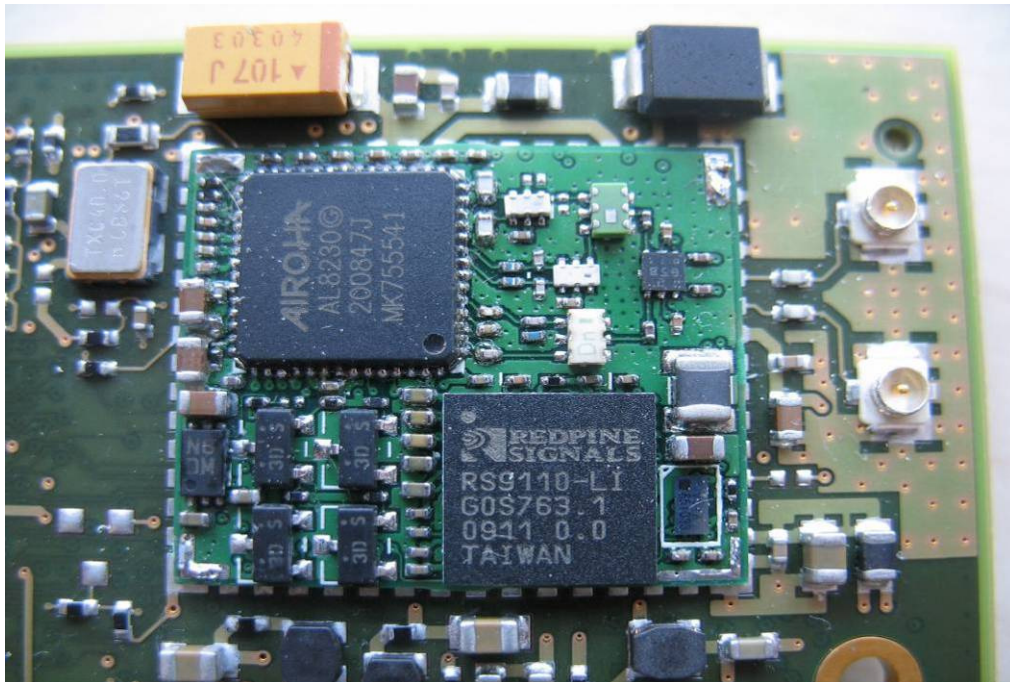

Photo 7: WLAN module / front side without shielding



Annex D Document history

Version	Applied changes	Date of release
1.0	Initial release	2011-02-23

Annex E Further information**Glossary**

DUT	-	Device under Test
EMC	-	Electromagnetic Compatibility
EUT	-	Equipment under Test
FCC	-	Federal Communication Commission
FCC ID	-	Company Identifier at FCC
HW	-	Hardware
IC	-	Industry Canada
Inv. No.	-	Inventory number
N/A	-	not applicable
S/N	-	Serial Number
SW	-	Software