



*Digi JumpStart for
Microsoft .NET Micro Framework
Getting Started Guide*

*Digi JumpStart for
Microsoft .NET Micro Framework
Getting Started Guide*

Part number/version: 90000860_B

Release date: November 2007

www.digiembedded.com

© Digi International Inc. 2007. All Rights Reserved.

Digi, Digi International, the Digi logo, ConnectPort, Watchport, and XBee, are trademarks or registered trademarks of Digi International, Inc. in the United States and other countries worldwide.

All other trademarks are the property of their respective owners.

Information in this document is subject to change without notice and does not represent a commitment on the part of Digi International.

Digi provides this document "as is," without warranty of any kind, either expressed or implied, including, but not limited to, the implied warranties of fitness or merchantability for a particular purpose. Digi may make improvements and/or changes in this manual or in the product(s) and/or the program(s) described in this manual at any time.

This product could include technical inaccuracies or typographical errors. Changes are periodically made to the information herein; these changes may be incorporated in new editions of the publication.



Contents



Using the .NET Micro Framework	1
Task 1: Get Ready.....	1
Task 2: Verify the contents of the JumpStart Kit	2
Task 3: Install the Microsoft Visual Studio 2005 software	3
Task 4: Install Digi JumpStart for Microsoft .NET Micro Framework.....	4
Task 5: Connect the hardware	5
Task 6: Discover the network IP address of the Digi Connect ME	7
Task 7: Debug your first C# application.....	10
Task 8: Create a new C# application	18





Using this guide

Review this section for basic information about this guide, as well as for general support contact information.

About this guide

This guide describes how to get started using the Digi JumpStart for Microsoft .NET Micro Framework as part of your product development.

For further instructions and samples of .NET applications, refer to on-line documentation.



Who should read this guide

This guide is for software engineers and others who use Digi JumpStart for Microsoft .NET Micro Framework. To complete the tasks described in this guide, you must:

- Be familiar with installing and configuring software.
- Have sufficient user privileges to do these tasks.
- Be familiar with network software and development board systems.

Customer support

To get help with a question or technical problem with this product, or to make comments and recommendations about our products or documentation, use the following contact information:

- United States telephone: 1 877 912-3444
- International telephone: 1 952 912-3444
- Address: Digi International
11001 Bren Road East
Minnetonka, MN 55343 U.S.A.
- Web site: www.digiembedded.com

Using the .NET Micro Framework

This guide takes you through the steps to compile, deploy, debug, and create a C# application for the Digi Connect ME using the Digi JumpStart for Microsoft .NET Micro Framework.



Plan to spend a few hours completing the tasks.

Task 1: Get Ready

In this task you will make sure you have enough disk space and memory to install all necessary components to run Microsoft .NET Micro Framework.

A successful installation requires a total of 10.1 GB on the install drive plus another 1GB on the system drive. 192MB RAM is minimum is required, but 256MB RAM recommended. Make sure your PC meets these requirements.

What's next?

Go on to the next task to verify the contents of the JumpStart kit.



Task 2: Verify the contents of the JumpStart Kit

In this task, you will verify the contents of the JumpStart kit.

The Digi JumpStart kit for Microsoft .NET Micro Framework kit includes hardware and software for using Microsoft .NET Micro Framework. Verify these items are included in your JumpStart kit:

- Digi JumpStart for Microsoft .NET Micro Framework installation CD
- Digi Connect ME .NET Micro Framework Developer Embedded Module, part number 50000878-18
- Microsoft Visual Studio 2005 Trial Version installation CDs
- Digi Connect ME development board
- 12VDC power supply for the Connect ME development board
- Ethernet cable
- Serial cable

What's next?

If Microsoft Visual Studio 2005 has been previously installed on your PC, skip to Task 4, "Install Digi JumpStart for Microsoft .NET Micro Framework." Otherwise go on to the next task to install Microsoft Visual Studio 2005.

Task 3: Install the Microsoft Visual Studio 2005 software

In this task, you will install Microsoft Visual Studio 2005. You must install Microsoft Visual Studio 2005 Standard (or better). You can use the Microsoft Visual Studio 2005 Professional (Trial Version) included in the JumpStart kit.

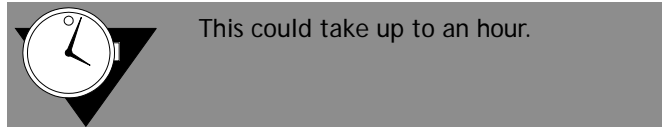

Follow these steps to install Microsoft Visual Studio 2005.

- 1 Place Visual Studio installation Disc 1 into your CD drive, and follow the wizard prompts.
- 2 When you are prompted to select features to install, Microsoft Visual C# 2005 must be selected at a minimum.

What's next?

Go on to the next task to install Digi JumpStart for Microsoft .NET Micro Framework.

Task 4: Install Digi JumpStart for Microsoft .NET Micro Framework

In this task, you will install Digi JumpStart for Microsoft .NET Micro Framework on your PC. This can take a couple of hours depending on what you already have installed on your PC and the speed of the PC.

To install Digi JumpStart for Microsoft .NET Micro Framework software place the Digi JumpStart for Microsoft .NET Micro Framework installation CD into your CD drive, and follow the wizard prompts.



This could take up to a couple of hours.

What's next?

Go on to the next task to setup the hardware.



Task 5: Connect the hardware

In this task, you will connect components included in your JumpStart kit to your development board.

- 1 Insert the Digi Connect ME module, labeled 50000878-18, into the Digi Connect ME Development board.

CAUTION: The Connect ME-MF sits loosely in the connector. Make certain the module is inserted into the development board prior to applying power.

2 Follow the set up steps as illustrated below.

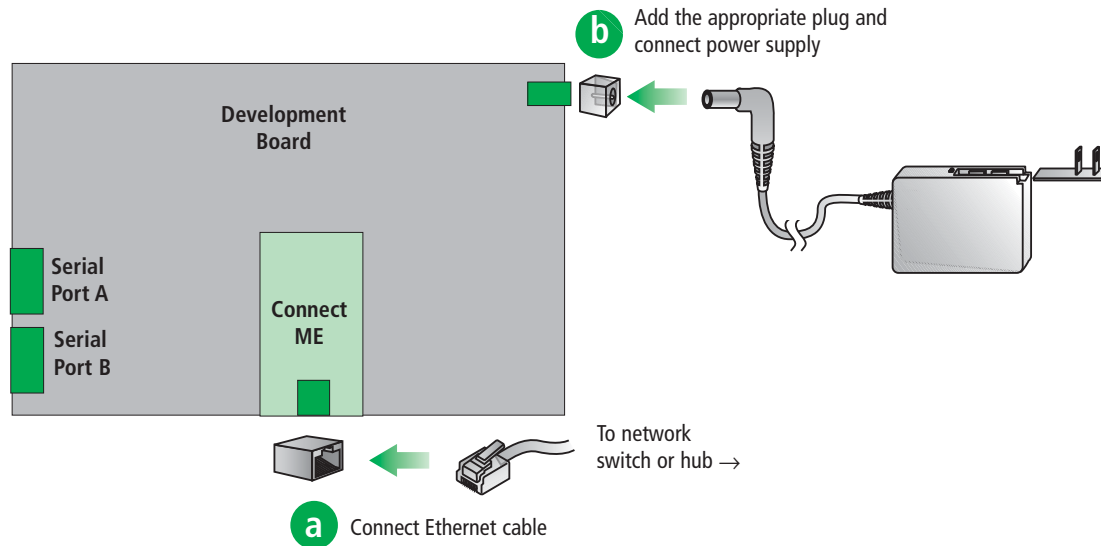

3 Connect the power supply to the outlet.

What's next?

Go to the next task to discover the IP address of the Digi Connect ME embedded module.

Task 6: Discover the network IP address of the Digi Connect ME

In this task, you will discover the network IP address of the Digi Connect ME embedded module.

To discover the IP address of the Digi Connect ME:

- 1 Start MFDeploy by double clicking the ICON on the desktop.



The .NET Micro Framework Deployment Tool dialog opens.

- 2 Select TCP/IP from the Device pull down menu. When the hour glass disappears, the discovery process is complete and an IP address should appear in the text box next to the Device pull down menu.

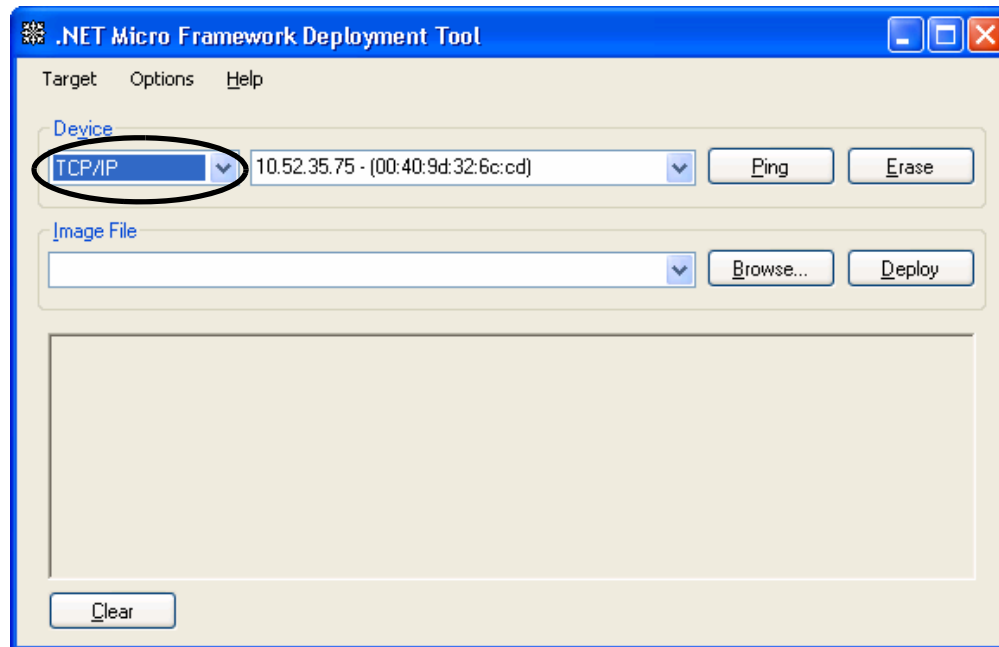

- 
- 3 Your device may show up or you may have to look for it using the pull down menu. Verify this is your Digi Connect ME embedded module by comparing the MAC address next to the discovered IP Address, to the MAC address on top of the Digi Connect ME. If this is the MAC address of your Connect ME, make note of the IP address for later use. If this is not the MAC address of your unit, select another device from the pull down menu and check the MAC address next to the discovered IP Address. If no devices are discovered, repeat step 2

Note: If you still cannot discover your device, go to the Troubleshooting section in Visual Studio 2005 online help. Launch Visual Studio 2005 and go to Help => Contents => Digi JumpStart for Microsoft. Net Micro Framework: Connect ME => Troubleshooting.

What's next?

Go on to the next task to debug your first C# application.



Task 7: Debug your first C# application

In this task, you will configure the GetNetworkInformation application to deploy over the network to your specific Digi Connect ME module. You will also set a break point in the application, compile, deploy/debug the application, and examine a local application variable.

To debug your first C# application:

- 1** Launch Microsoft Visual Studio 2005.
- 2** From the File pull down menu, select File => Open => Project/Solution \Program Files\Digi\Digi JumpStart for Microsoft .NET Micro Framework \Samples\GetNetworkInformation\GetNetworkInformation.sln.

- 3 Right mouse click on GetNetworkInformation in the Solution Explorer window, then click Properties and the Application screen appears.

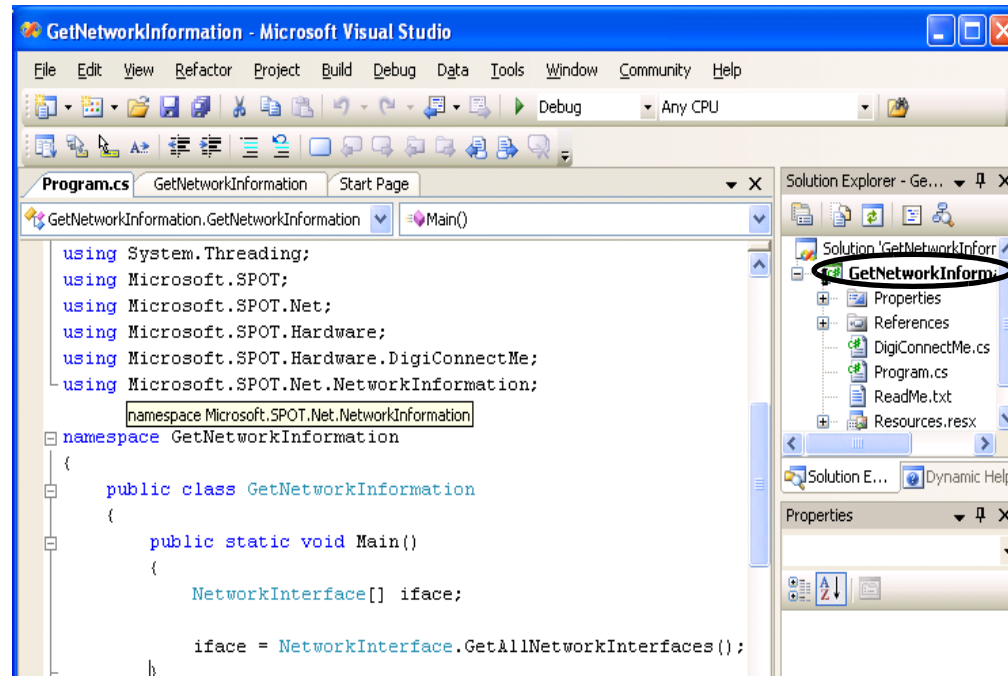

- 4 Click on the Micro Framework tab on the left and the Micro Framework screen appears.

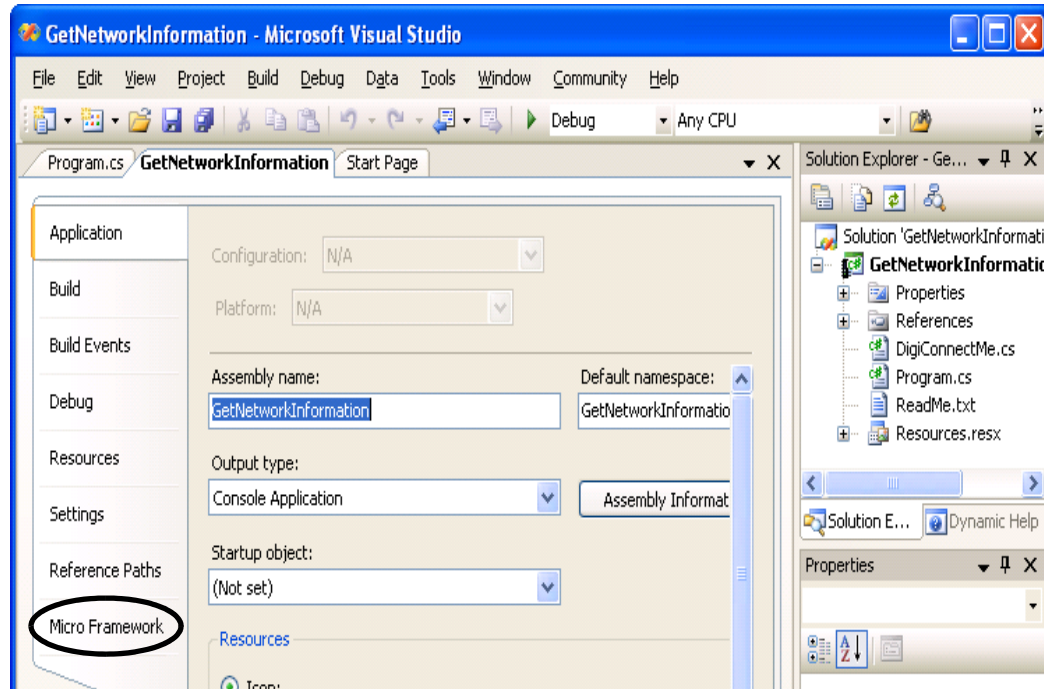

- 6 Save your changes by selecting File => Save All.
- 7 Enable the output window by selecting View => Output.
- 8 Double click Program.cs in the Solution Explorer window and your window should look like this:

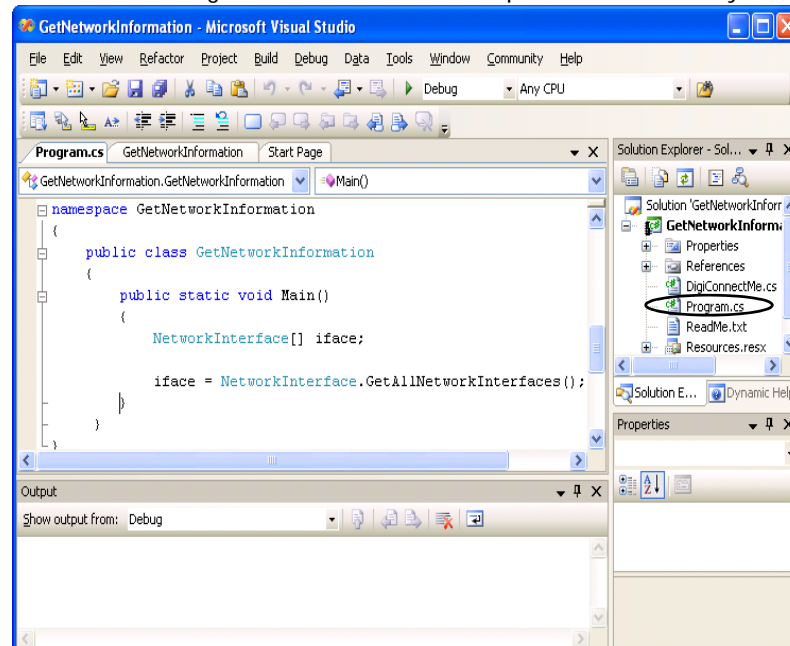

9 Right click to the left of the close bracket under the iface = statement and select Breakpoint=> Insert Breakpoint.

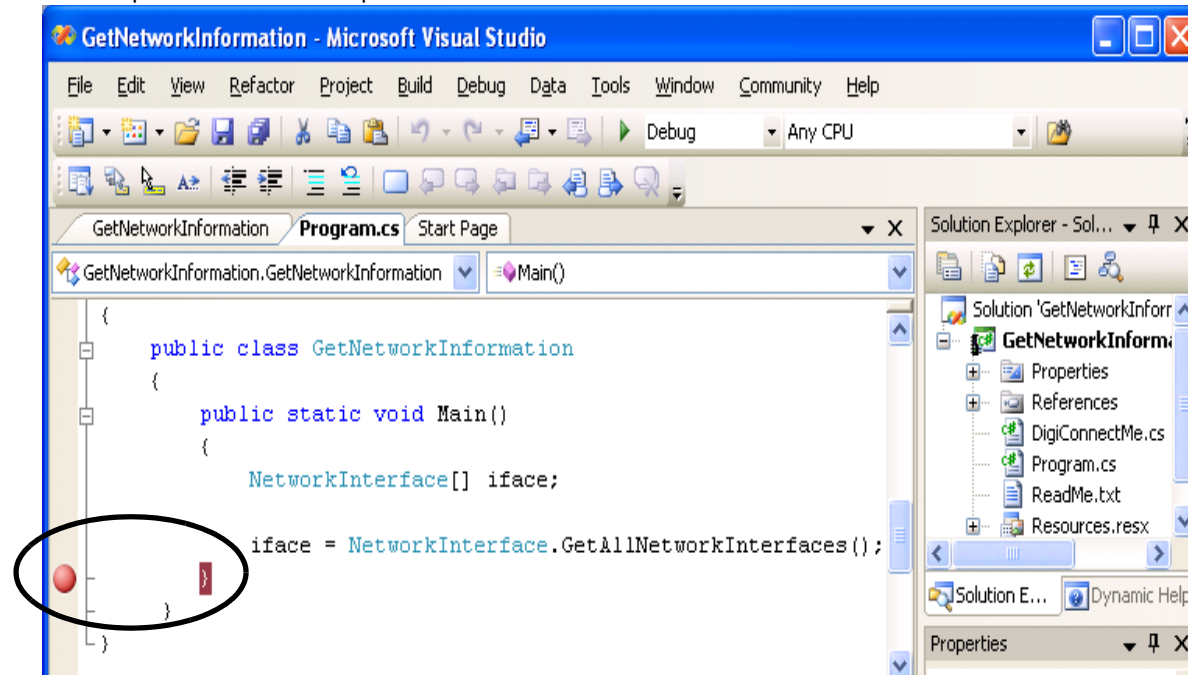

- 10 Click the Start Debugging icon (the Green arrow) on the Toolbar to compile and deploy the application to the Connect ME. After a short period, you should be stopped at your breakpoint, and your screen should look like this:

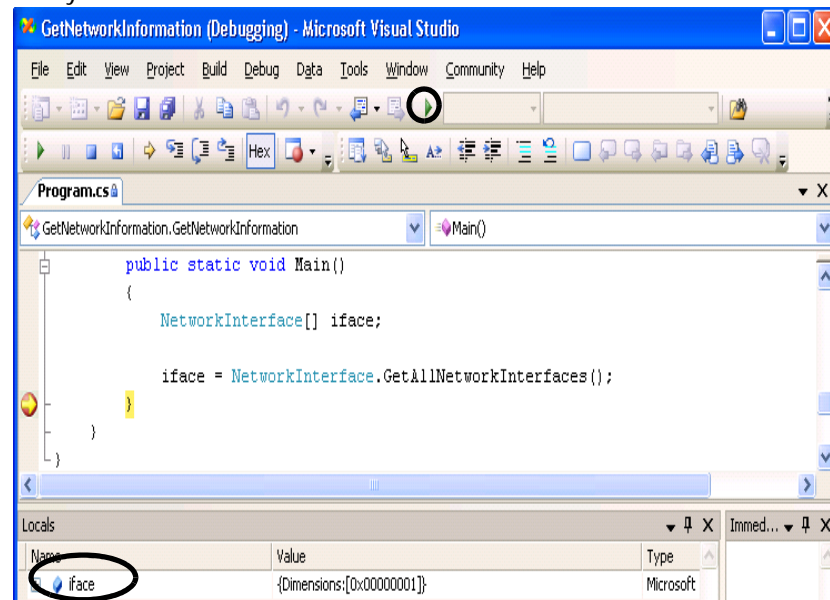

- 11 Expand the iface variable in the local window on the bottom left, and you will see the network IP address setting of your device.



12 Select File => Close Solution.

What's next?

Go on to the next task to create a new C# application.

Task 8: Create a new C# application

In this task, you will use the Digi Connect ME Template to create a new C# application.

- 1 From the file menu, select File => New => Project and the New Project window opens.

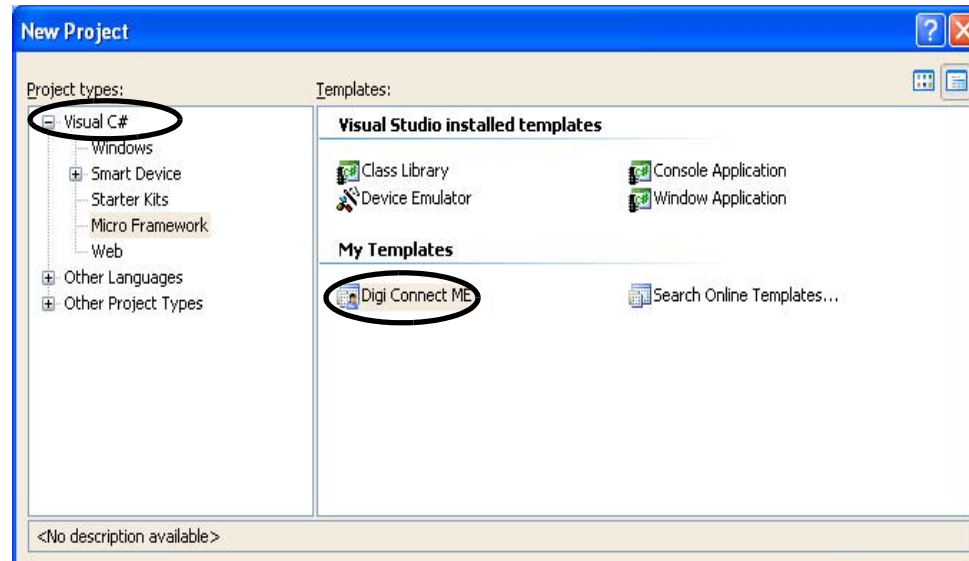

- 2 Select Visual C# => Micro Framework under Project Types.
- 3 Select Digi Connect ME under My Templates.

- 
- 4 Enter the name of your new application in the Name field and select OK.
 - 5 Save your changes by selecting File => Save All.
 - 6 Congratulations, you have completed the Getting Started procedure.

What's next?

You are now ready to develop your own C# applications for the Digi Connect ME. For instance, you can extend and complete the new C# application created with the Digi Connect ME Template.

For other helpful information on developing C# applications for the Digi Connect ME, see the Reference section in the Visual Studio Help Contents for the Digi JumpStart for Microsoft .NET Micro Framework: Connect ME.



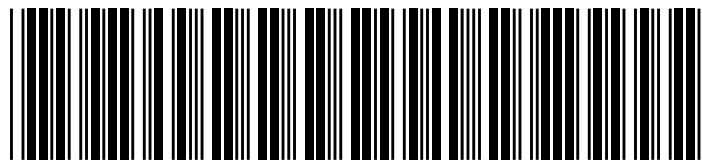

PN: (1P) 90000860-88 B