

NOT INSTALLED

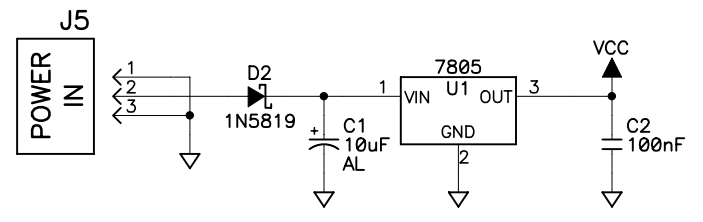

AFTER RUNNING DEMO PROGRAMS,
CAN CUT TRACES IN JP1 TO DISCONNECT
LEDS AND SWITCHES

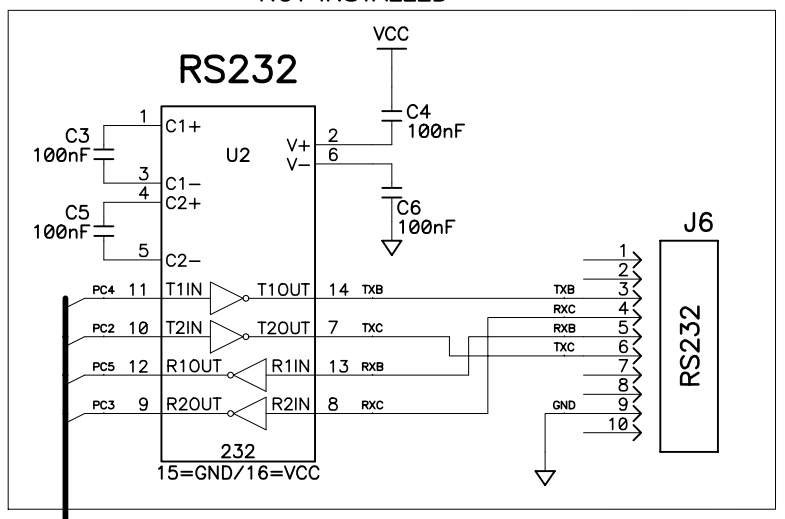
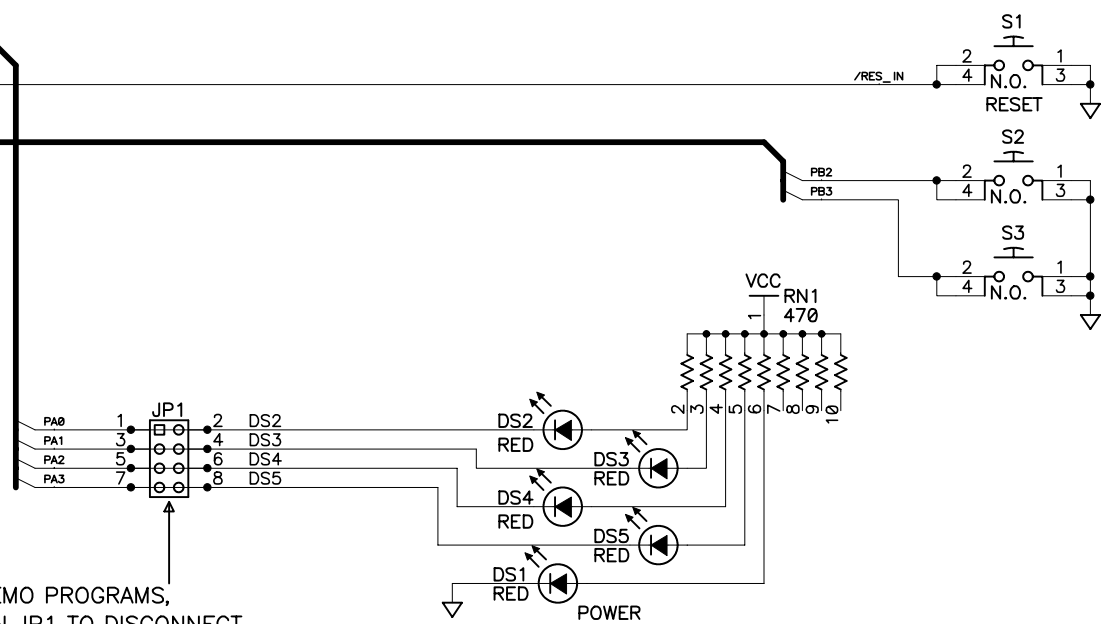

COPYRIGHT 2000, Z-WORLD, INC.

REVISION HISTORY			REVISION APPROVAL			
REV	ECO	DESCRIPTION	PROJECT ENGINEER	APPROVAL DATE	DOCUMENT CONTROL	APPROVAL DATE
A	E11244	INITIAL RELEASE A/W @ REV-A	DM	10/26/00	KLS	10/26/00

APPEND THE FOLLOWING DOCUMENTS WHEN CHANGING THIS DOCUMENT:		DRAWING CONTENT:	
		DRAWN BY: (INITIAL RELEASE)	200CT00
		KAH	
		REVISED BY:	220CT00
		KAH	
APPROVALS: INITIAL RELEASE			
		PROJECT ENGINEER:	10/26/00
		Darren Musgrove	
		ENGINEERING MANAGER:	10/26/00
		R. Matthews	
		SIGNATURES	DATE

TITLE		SCHEMATIC DIAGRAM ETHERNET CORE MODULE PROTOTYPING BOARD	
SIZE	DWG NO.	090-0116	
B		SCALE	NONE
		RELEASE DATE	
SHEET	1	OF	2

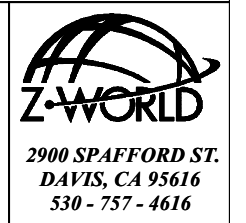

SURFACE MOUNT PROTOTYPING PADS

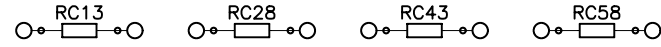
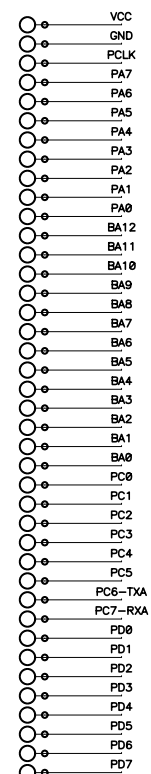
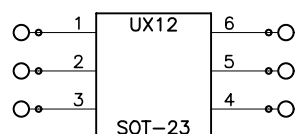
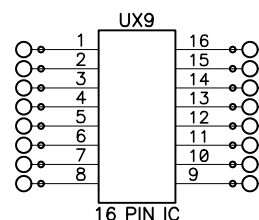
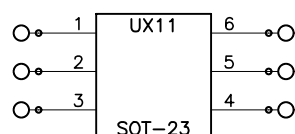
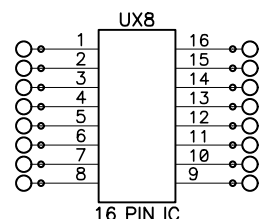
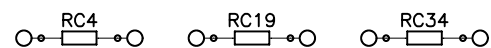
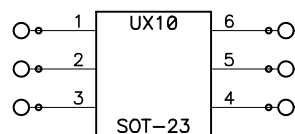
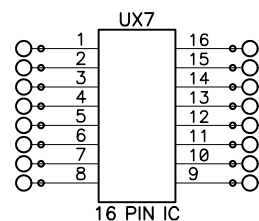
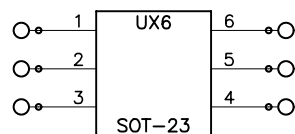
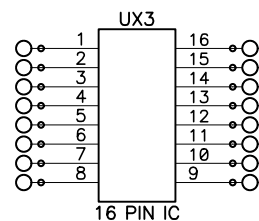
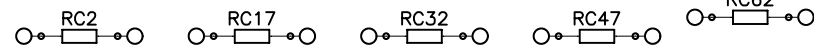
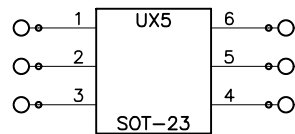
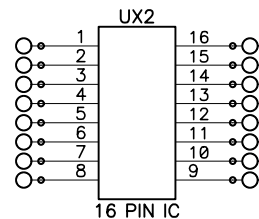
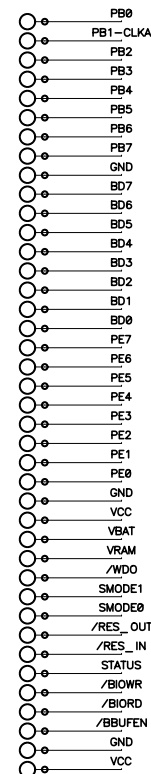
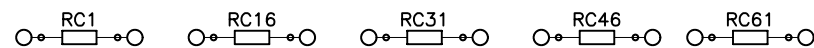
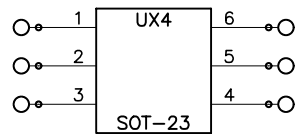
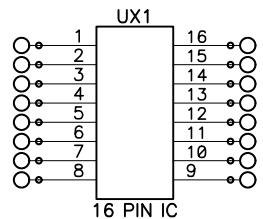

COPYRIGHT 2000, Z-WORLD, INC.

SIZE B	DWG NO. 090-0116
SCALE NONE	REV LTR A
SHEET 2 OF 2	