

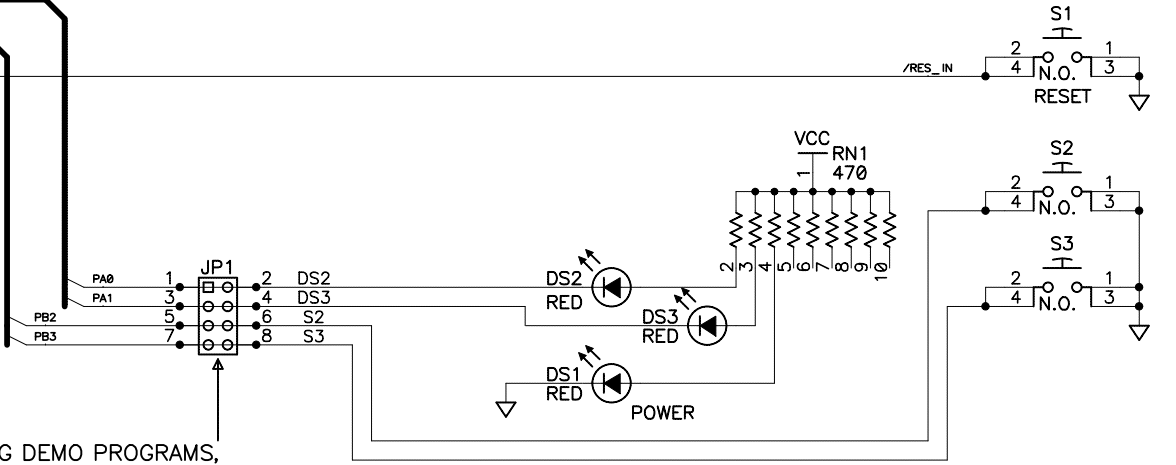

AFTER RUNNING DEMO PROGRAMS,
CAN CUT TRACES IN JP1 TO DISCONNECT
LEDS AND SWITCHES



REVISION HISTORY			REVISION APPROVAL			
REV	ECO	DESCRIPTION	PROJECT ENGINEER	APPROVAL DATE	DOCUMENT CONTROL	APPROVAL DATE
A	E11005	INITIAL RELEASE A/W @ REV-A				

COPYRIGHT 2000, Z-WORLD, INC.

APPEND THE FOLLOWING DOCUMENTS WHEN CHANGING THIS DOCUMENT:		DRAWING CONTENT:		TITLE	
		DRAWN BY: (INITIAL RELEASE)	KAH	SCHEMATIC DIAGRAM	
		REVISED BY:	KAH	RCM2000 SERIES	
		APPROVALS: INITIAL RELEASE		PROTOTYPING	
		PROJECT ENGINEER:		BOARD	
		ENGINEERING MANAGER:		SIZE	DWG NO.
				B	090-0099
		SIGNATURES	DATE	SCALE	RELEASE DATE
				NONE	



2900 SPAFFORD ST.
DAVIS, CA 95616
530 - 757 - 4616

SURFACE MOUNT PROTOTYPING PADS

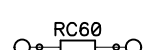
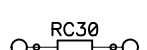
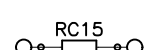
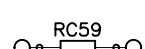
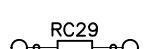
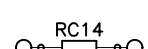
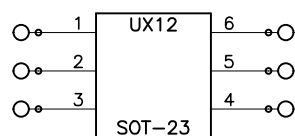
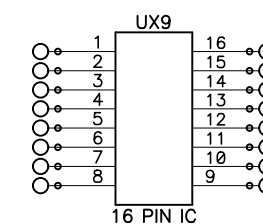
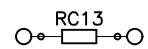
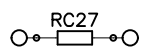
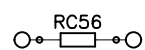
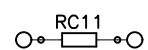
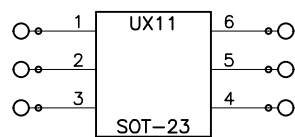
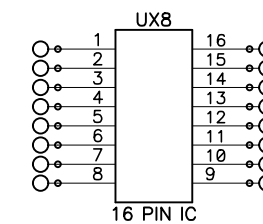
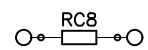
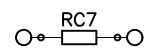
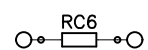
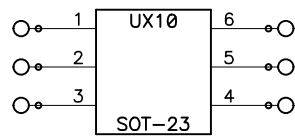
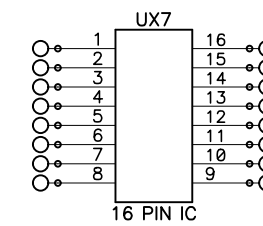
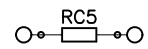
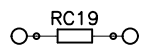
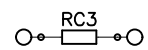
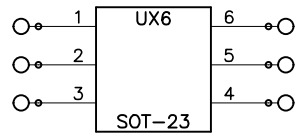
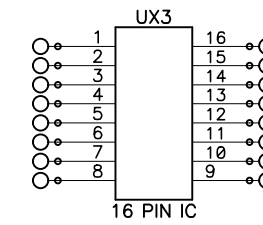
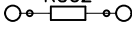
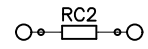
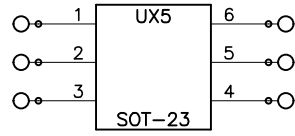
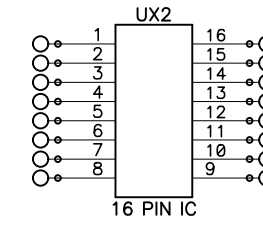
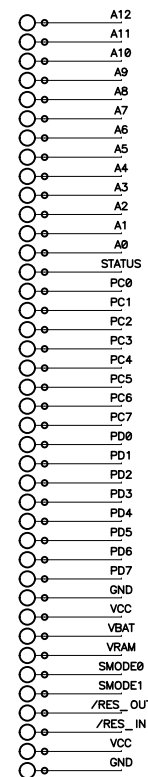
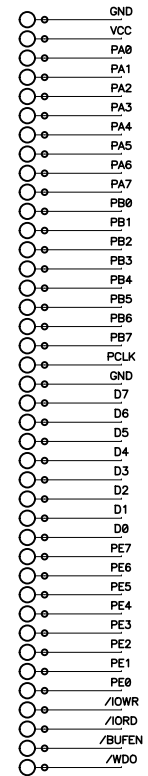
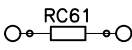
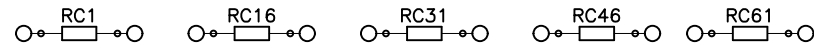
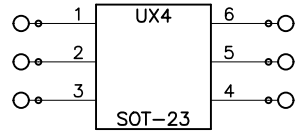
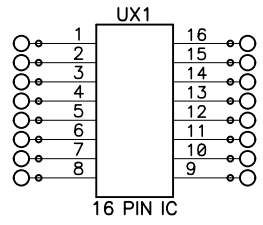

COPYRIGHT 2000, Z-WORLD, INC.

SIZE B	DWG NO. 090-0099
SCALE NONE	REV LTR A
SHEET 2 OF 2	